

FIYAT LİSTESİ
HAZİRAN 2014

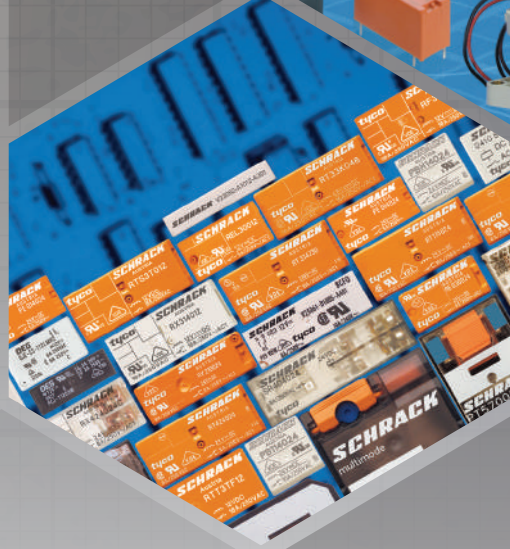
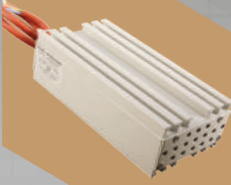

LV-10

PANO LEDLİ AYDINLATMA ARMATÜRÜ

Teknik Parametreler

| | |
|---------------------|--------------------------------------|
| Voltage | AC/DC 110~220V |
| Luminary | Ultra bright LED |
| Amibent Temperature | -25°C~+55°C |
| Amibent Humidity | 20%RH~90%RH |
| Lifespan | 100000hrs |
| Lightning Impulse | 2KV |
| Power Consumption | ≤1W |
| Installation Hole | Diameter:4.4x2 hole distance:100(mm) |
| Installation Mode | Installed with M4 screw |
| Rotation Angle | 40 degree (right and left) |

Ölçüler

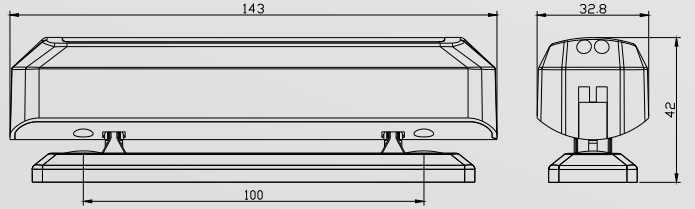

**YENİ
ÜRÜN**

EKONOMİ SLİM RÖLE SETİ

24 VDC 1CO 8A

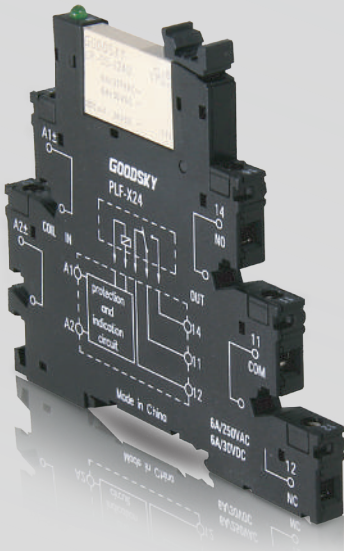

LEIPOLD İKİLİ TERMOSTATLAR

1NO+1NC



**YENİ
ÜRÜN**

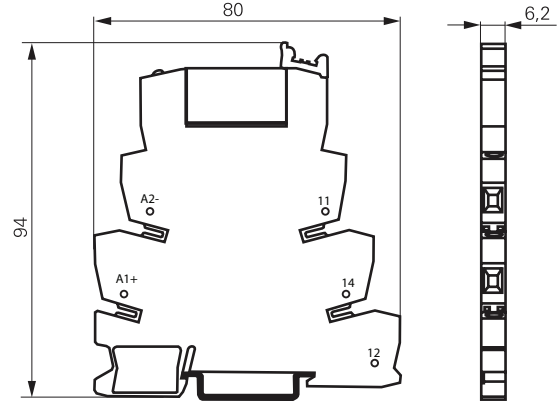
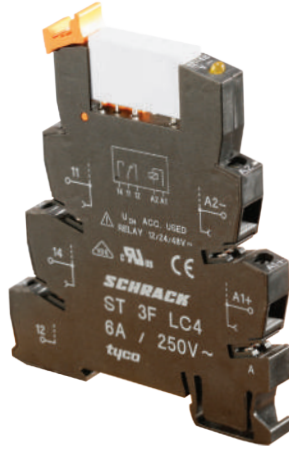

| SİP NO | TİPİ | AÇIKLAMA | PAKET MİKTARI | FİYAT |
|----------------------------------|---------------|--|---------------|---------|
| PLC RÖLE SETLERİ (6 mm) | | | | |
| 090-210 | ST3P3LB2 | 012 VDC 1 C/O 6A SLİM RÖLE + VİDALI SOKET | 10 | 9,90 € |
| 090-215 | ST4P3LB2 | 012 VDC 1 C/O 6A SLİM RÖLE + YAYLI SOKET | 10 | 10,20 € |
| 090-220 | ST3P3LC4 | 024 VDC 1 C/O 6A SLİM RÖLE + VİDALI SOKET | 10 | 9,90 € |
| 090-221 | ST4P3LC4 | 024 VDC 1 C/O 6A SLİM RÖLE + YAYLI SOKET | 10 | 10,20 € |
| 090-225 | ST3P3SM5 | 115 VAC 1 C/O 6A SLİM RÖLE + VİDALI SOKET | 10 | 11,50 € |
| 090-230 | ST3P3TP0 | 230 VAC 1 C/O 6A SLİM RÖLE + VİDALI SOKET | 10 | 11,50 € |
| 090-261 | V23092-12 SET | 012 VDC 1 C/O 6A SCHRACK RÖLE + EKO SOKET | 10 | 7,00 € |
| 090-262 | V23092-24 SET | 024 VDC 1 C/O 6A SCHRACK RÖLE + EKO SOKET | 10 | 7,00 € |
| 090-270 | PLF-X24/LR24 | 024 VDC 1 C/O 8A SLİM RÖLE + VİDALI SOKET (EKONOMİK) | 10 | 6,00 € |

| SİP NO | TİPİ | AÇIKLAMA | PAKET MİKTARI | FİYAT |
|-----------------------------------|-------------|---|---------------|---------|
| PLC OPTOKUPLÖRLER (6 mm) | | | | |
| 090-300 | ST3P3SS4 | 24/24 DC 2A SOLID STATE RÖLE + VİDALI SOKET | 5 | 23,00 € |
| 090-350 | ST4P3SS4 | 24/24 DC 2A SOLID STATE RÖLE + YAYLI SOKET | 5 | 24,00 € |
| 320-290 | SSR 01D-224 | 24/24 DC 2 A SOLID STATE RÖLE | 10 | 16,50 € |

| SİP NO | TİPİ | AÇIKLAMA | PAKET MİKTARI | FİYAT |
|-----------------------------|-------------------|---|---------------|---------|
| PLC RÖLELER (6 mm) | | | | |
| 090-075 | LR-SS-124D | 024 VDC 1 C/O 8A SLİM RÖLE 170 mW (EKONOMİK) | 50 | 3,00 € |
| 090-010 | V23092-A1005-A301 | 005 VDC 1 C/O 6A SLİM RÖLE 170 mW | 20 | 4,10 € |
| 090-015 | V23092-A1012-A301 | 012 VDC 1 C/O 6A SLİM RÖLE 170 mW | 20 | 4,10 € |
| 090-025 | V23092-A1024-A301 | 024 VDC 1 C/O 6A SLİM RÖLE 170 mW | 20 | 4,10 € |
| 090-041 | V23092-A1060-A301 | 060 VDC 1 C/O 6A SLİM RÖLE 170 mW (230 AC İÇİN) | 20 | 11,50 € |
| 090-111 | PCN105-D3MHZ | 005 VDC 1 N/O 3A PLC RÖLESİ 120 mW | 160 | 2,57 € |
| 090-114 | PCN112-D3MHZ | 012 VDC 1 N/O 3A PLC RÖLESİ 120 mW | 160 | 2,57 € |
| 090-115 | PCN124-D3MHZ | 024 VDC 1 N/O 3A PLC RÖLESİ 120 mW | 25 | 2,57 € |

| SİP NO | TİPİ | AÇIKLAMA | PAKET MİKTARI | FİYAT |
|------------------------------|---------|--|---------------|---------|
| PLC RÖLE AKSESUARLARI | | | | |
| 090-910 | ST36040 | SOKET AYIRMA PLAKASI | 10 | 1,85 € |
| 090-920 | ST37001 | 50 CM KÖPRÜ KIRMIZI (80 SOKET KÖPRÜLER) | 1 | 17,20 € |
| 090-921 | ST37002 | 50 CM KÖPRÜ MAVİ (80 SOKET KÖPRÜLER) | 1 | 17,20 € |
| 090-922 | ST37003 | 50 CM KÖPRÜ GRİ (80 SOKET KÖPRÜLER) | 1 | 17,20 € |
| 090-933 | UCTM | SLİM SOKET ETİKETİ (1PLK =80 ADET) | 1 PLK | 5,40 € |
| 090-924 | KB 20 | EKONOMİK SERİ SOKET BARASI | 10 | 2,00 € |
| 800-876 | PLF-X24 | SLİM RÖLE SOKETİ (EKONOMİK) 88.6 x 76 x 6.02 | 20 | 5,00 € |

| SİP NO | TİPİ | AÇIKLAMA | PAKET MİKTARI | FİYAT |
|---|-------------------|--|---------------|--------|
| RT SERİSİ RÖLELER (400 mW) | | | | |
| 105-100 | RT 114012 | 012 VDC 1 C/O 12A PCB RÖLE 5 PIN 3.5 mm | 20 | 2,25 € |
| 105-120 | RT 114024 | 024 VDC 1 C/O 12A PCB RÖLE 5 PIN 3.5 mm | 20 | 2,25 € |
| 105-130 | RT 114730 | 230 VAC 1 C/O 12A PCB RÖLE 5 PIN 3.5 mm | 20 | 4,50 € |
| 105-210 | RT 214012 | 012 VDC 1 C/O 12A PCB RÖLE 5 PIN 5.0 mm | 20 | 2,22 € |
| 105-220 | RT 214024 | 024 VDC 1 C/O 12A PCB RÖLE 5 PIN 5.0 mm | 20 | 2,22 € |
| 105-230 | RT 214730 | 230 VAC 1 C/O 12A PCB RÖLE 5 PIN 5.0 mm | 20 | 4,25 € |
| 105-304 | RT 314005 | 005 VDC 1 C/O 16A PCB RÖLE 8 PIN | 20 | 2,75 € |
| 105-310 | RT 314012 | 012 VDC 1 C/O 16A PCB RÖLE 8 PIN | 20 | 2,22 € |
| 105-315 | RT 314024 | 024 VDC 1 C/O 16A PCB RÖLE 8 PIN | 20 | 2,22 € |
| 105-325 | RT 314524 | 024 VAC 1 C/O 16A PCB RÖLE 8 PIN | 20 | 2,90 € |
| 105-335 | RT 314730 | 230 VAC 1 C/O 16A PCB RÖLE 8 PIN | 20 | 4,35 € |
| 105-410 | RT 424012 | 012 VDC 2 C/O 08A PCB RÖLE 8 PIN | 20 | 2,25 € |
| 105-415 | RT 424024 | 024 VDC 2 C/O 08A PCB RÖLE 8 PIN | 20 | 2,25 € |
| 105-420 | RT 424048 | 048 VDC 2 C/O 08A PCB RÖLE 8 PIN | 20 | 2,64 € |
| 105-425 | RT 424060 | 060 VDC 2 C/O 08A PCB RÖLE 8 PIN | 20 | 4,90 € |
| 105-430 | RT 424110 | 110 VDC 2 C/O 08A PCB RÖLE 8 PIN | 20 | 5,06 € |
| 105-435 | RT 424524 | 024 VAC 2 C/O 08A PCB RÖLE 8 PIN | 20 | 3,05 € |
| 105-440 | RT 424548 | 048 VAC 2 C/O 08A PCB RÖLE 8 PIN | 20 | 3,40 € |
| 105-445 | RT 424730 | 230 VAC 2 C/O 08A PCB RÖLE 8 PIN | 20 | 4,34 € |
| 105-460 | RT 425615 | 115 VAC 2 C/O 08A PCB RÖLE 8 PIN | 20 | 4,45 € |
| 105-376 | RT 33L012 | 012 VDC 1 N/O 16A INRUSH RÖLE (20mS-80A) | 20 | 2,85 € |
| 105-382 | RT 33L024 | 024 VDC 1 N/O 16A INRUSH RÖLE (20mS-80A) | 20 | 2,90 € |
| RX SERİSİ PCB RÖLELER (500 mW) | | | | |
| 100-110 | RX 114012 | 012 VDC 1 C/O 12A PCB RÖLE 5 PIN 3.5 mm BEYAZ | 20 | 2,20 € |
| 100-130 | RX 114730 | 230 VAC 1 C/O 12A PCB RÖLE 5 PIN 3.5 mm BEYAZ | 20 | 4,25 € |
| 100-400 | RX 424005 | 005 VDC 2 C/O 08A PCB RÖLE 8 PIN BEYAZ | 20 | 2,46 € |
| 100-410 | RX 424012 | 012 VDC 2 C/O 08A PCB RÖLE 8 PIN BEYAZ | 20 | 2,20 € |
| 100-411 | RX 424012C | 012 VDC 2 C/O 08A PCB RÖLE 8 PIN ŞEFFAF | 20 | 2,20 € |
| 100-421 | RX 424024C | 024 VDC 2 C/O 08A PCB RÖLE 8 PIN ŞEFFAF | 20 | 2,20 € |
| 100-430 | RX 424048 | 048 VDC 2 C/O 08A PCB RÖLE 8 PIN BEYAZ | 20 | 2,50 € |
| 100-471 | RX 424730C | 230 VAC 2 C/O 08A PCB RÖLE 8 PIN ŞEFFAF | 20 | 4,25 € |
| RZ SERİSİ PCB RÖLELER (400 mW) | | | | |
| 112-047 | RZ01-1C4-D012-R | 012 VDC 1 C/O 12A PCB RÖLE 5 PIN 3.5 mm | 20 | 1,85 € |
| 112-046 | RZ01-1C4-D024-R | 024 VDC 1 C/O 12A PCB RÖLE 5 PIN 3.5 mm | 20 | 1,85 € |
| 112-062 | RZ03-1C4-D012-R | 012 VDC 1 C/O 16A PCB RÖLE 8 PIN | 20 | 1,85 € |
| 112-060 | RZ03-1C4-D024-R | 024 VDC 1 C/O 16A PCB RÖLE 8 PIN | 20 | 1,85 € |
| V23057 SERİSİ RÖLELER (500 mW) | | | | |
| 111-030 | V23057-B0002-A101 | 012 VDC 1 C/O 08A PCB RÖLE (DIK TİP) | 20 | ☎ |
| 111-040 | V23057-B0006-A101 | 024 VDC 1 C/O 08A PCB RÖLE (DIK TİP) | 20 | ☎ |
| 111-045 | V23057-B0028-A401 | 110 VDC 1 C/O 08A PCB RÖLE (DIK TİP) | 20 | ☎ |
| RP SERİSİ PCB RÖLELER (500 mW) | | | | |
| 110-320 | RP 310024 | 024 VDC 1 C/O 16A PCB RÖLE 8 PIN | 20 | 2,80 € |
| 110-405 | RP 410012 | 012 VDC 1 C/O 12A PCB RÖLE 5 PIN | 20 | 2,80 € |
| 110-450 | RP 420012 | 012 VDC 2 C/O 08A PCB RÖLE 8 PIN | 20 | 2,80 € |
| 110-460 | RP 420024 | 024 VDC 2 C/O 08A PCB RÖLE 8 PIN | 20 | 2,80 € |
| 110-380 | RP 35L024 | 024 VDC 1 N/O 16A INRUSH RÖLE (20mS-120A) | 20 | 4,10 € |
| XT SERİSİ ENDÜSTRİYEL RÖLELER (400 mW) | | | | |
| 107-010 | XT 374LC4 | 024 VDC 1 C/O 16A END. RÖLE (T.BUTON+LED+KD) | 10 | 4,20 € |
| 107-020 | XT 374R24 | 024 VAC 1 C/O 16A END. RÖLE (T.BUTON+LED) | 10 | 5,51 € |
| 107-030 | XT 374T30 | 230 VAC 1 C/O 16A END. RÖLE (T.BUTON+LED) | 10 | 5,78 € |
| 107-110 | XT 484LC4 | 024 VDC 2 C/O 08A END. RÖLE (T.BUTON+LED+KD) | 10 | 4,73 € |
| 107-120 | XT 484R24 | 024 VAC 2 C/O 08A END. RÖLE (T.BUTON+LED) | 10 | 6,04 € |
| 107-130 | XT 484T30 | 230 VAC 2 C/O 08A END. RÖLE (T.BUTON+LED) | 10 | 6,30 € |

1 form C (CO) contact

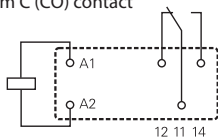

1 form C (CO) contact

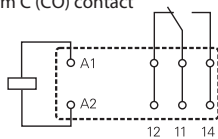

1 form C (CO) contact

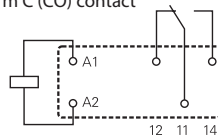

2 form C (CO) contacts

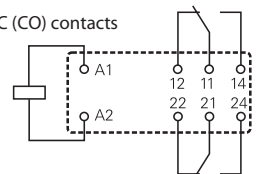

| SİP NO | TİPİ | AÇIKLAMA | PAKET MİKTARI | FİYAT |
|------------------------------|-----------|--|---------------|--------|
| PCB RÖLE AKSESUARLARI | | | | |
| 119-109 | YRT 78624 | 05 PIN RAY TİPİ KISA SOKET VİDALI (1 C/O 3.5 mm RÖLE İÇİN) | 20 | 2,99 € |
| 119-110 | YRT 78625 | 08 PIN RAY TİPİ KISA SOKET VİDALI (1 C/O ve 2 C/O RÖLE İÇİN) | 20 | 2,99 € |
| 119-130 | YRT 78626 | 08 PIN RAY TİPİ UZUN SOKET VİDALI (1 C/O ve 2 C/O RÖLE İÇİN) | 20 | 2,99 € |
| 119-135 | RT 78725 | 08 PIN RAY TİPİ KISA SOKET VİDALI (1 C/O ve 2 C/O RÖLE İÇİN) | 10 | 3,08 € |
| 119-140 | RT 78726 | 08 PIN RAY TİPİ UZUN SOKET VİDALI (1 C/O ve 2 C/O RÖLE İÇİN) | 10 | 3,08 € |
| 119-250 | RT 7872P | 08 PIN RAY TİPİ SOKET YAYLI (1 C/O ve 2 C/O RÖLE İÇİN) | 20 | 3,80 € |
| 119-220 | RP 78600 | 05 PIN PCB TİPİ SOKET (V23057 RÖLE İÇİN) | 100 | 0,92 € |
| 119-230 | RP 78601 | 05 PIN PCB TİPİ SOKET (1 C/O 3.5 mm RÖLE İÇİN) | 100 | 0,92 € |
| 119-240 | RP 78602 | 08 PIN PCB TİPİ SOKET (1 C/O ve 2 C/O RÖLE İÇİN) | 100 | 0,92 € |
| 119-300 | RT 16016 | KLİPS (YRT 78624 - 78625 - 78626 İÇİN) | 20 | 0,20 € |
| 119-310 | RT 17017 | KLİPS (RT 78725 - RT 78726 İÇİN) | 10 | 0,20 € |
| 119-320 | XT 17017 | KLİPS (XT TİPİ RÖLELER İÇİN RT 78725-RT 78726 UYUMLU) | 10 | 0,22 € |
| 119-340 | RP 16104 | M KLİPS (RP TİPİ RÖLELER İÇİN) | 20 | 0,20 € |
| 119-370 | RT 16041 | M KLİPS (78600-601-602 İÇİN) | 100 | 0,20 € |
| 119-400 | RY 16040 | ETİKET (YRT 78624 - 78625 - 78626 İÇİN) | 20 | 0,16 € |
| 119-410 | RT 17040 | ETİKET (RT 78725-RT 78726 İÇİN) | 10 | 0,16 € |
| 119-420 | RT 170R8 | VİDALI SOKET KÖPRÜSÜ 8 'Lİ (RT VE YRT SOKETLERİ İÇİN) | 1 | 4,50 € |
| 119-430 | RT 170P1 | YAYLI SOKET KÖPRÜSÜ TEKLİ (RT 7872P İÇİN) | 1 | 0,75 € |



| PTML TİPİ LED VE KORUMA MODÜLLERİ (RT SERİSİ SOKETLER İÇİN) | | | | |
|--|------------|---|----|--------|
| 120-011 | PTM L0 024 | 006-024 VDC LM 18 LED +KORUMA DIODU (A1+/A2-) | 10 | 2,40 € |
| 120-021 | PTM L0 524 | 006-024 VAC LM 07 LED MODÜLÜ | 10 | 2,40 € |
| 120-026 | PTM L0 110 | 048-110 VDC LM 20 LED +KORUMA DIODU (A1+/A2-) | 10 | 2,50 € |
| 120-031 | PTM L0 730 | 110-230 VAC LM 06 LED MODÜLÜ | 10 | 2,50 € |
| 120-040 | PTM T0 0A0 | 006-220 VDC EM 09 KORUMA DİADU A1 + / A2 - | 10 | 2,20 € |
| 120-046 | PTM V0 524 | 024 VAC LM 04 VARİSTÖR MODÜLÜ | 10 | 2,40 € |
| 120-051 | PTM V0 730 | 230 VAC LM 05 VARİSTÖR MODÜLÜ | 10 | 2,40 € |
| 120-060 | PTM U0 524 | 006-060 VAC RC KORUMA MODÜLÜ | 10 | 2,50 € |
| 120-063 | PTM U0 730 | 110-230 VAC RC KORUMA MODÜLÜ | 10 | 2,50 € |



| RTL LED VE KORUMA MODÜLLERİ (YRT SERİSİ SOKETLER İÇİN) | | | | |
|---|------------|--|----|--------|
| 120-100 | RTL M0 024 | 006-024 VDC LED+KORUMA DIODU (A1+/A2-) | 20 | 2,40 € |
| 120-103 | RTL M0 048 | 024-060 VDC LED+KORUMA DIODU (A1+/A2-) | 20 | 2,40 € |
| 120-105 | RTL M0 524 | 024-060 VAC LED MODÜLÜ | 20 | 2,40 € |
| 120-104 | RTL M0 110 | 110-230 VDC LED+KORUMA DIODU (A1+/A2-) | 20 | 2,50 € |
| 120-110 | RTL M0 730 | 110-230 VAC LED MODÜLÜ | 20 | 2,50 € |
| 120-300 | RPM U0 548 | 024-048 VAC RC KORUMA MODÜLÜ | 20 | 2,50 € |
| 120-310 | RPM U0 730 | 110-230 VAC RC KORUMA MODÜLÜ | 20 | 2,50 € |
| 120-320 | RPM T0 0A0 | KORUMA DİODU 1N4007 (A1+/A2-) | 20 | 2,20 € |

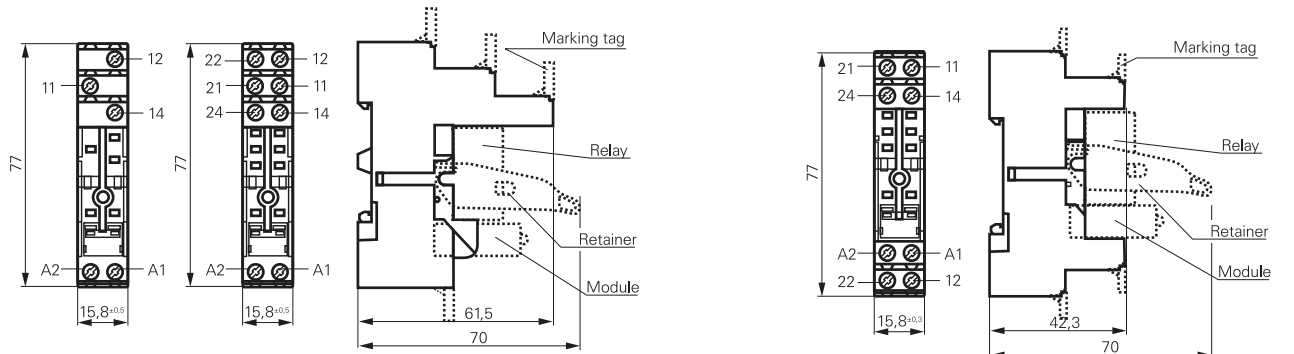

RÖLELER

| SİP NO | TİPİ | AÇIKLAMA | PAKET MİKTARI | FİYAT |
|---|-----------|-----------------------------------|---------------|--------|
| PT SERİSİ ENDÜSTRİYEL RÖLELER (TEST BUTONLU) | | | | |
| 200-210 | PT 270024 | 024 VDC 2 C/O 12A END. RÖLE | 10 | 5,41 € |
| 200-230 | PT 270730 | 230 VAC 2 C/O 12A END. RÖLE | 10 | 5,81 € |
| 200-310 | PT 370012 | 012 VDC 3 C/O 10A END. RÖLE | 10 | 5,61 € |
| 200-320 | PT 370024 | 024 VDC 3 C/O 10A END. RÖLE | 10 | 5,61 € |
| 200-330 | PT 370048 | 048 VDC 3 C/O 10A END. RÖLE | 10 | 6,43 € |
| 200-340 | PT 370110 | 110 VDC 3 C/O 10A END. RÖLE | 10 | 6,11 € |
| 200-342 | PT 370125 | 125 VDC 3 C/O 10A END. RÖLE | 10 | ☎ |
| 200-341 | PT 370220 | 220 VDC 3 C/O 10A END. RÖLE | 10 | 7,04 € |
| 200-350 | PT 370524 | 024 VAC 3 C/O 10A END. RÖLE | 10 | 5,61 € |
| 200-360 | PT 370615 | 115 VAC 3 C/O 10A END. RÖLE | 10 | 5,81 € |
| 200-370 | PT 370730 | 230 VAC 3 C/O 10A END. RÖLE | 10 | 5,92 € |
| 200-405 | PT 570012 | 012 VDC 4 C/O 06A END. RÖLE | 10 | 5,36 € |
| 200-410 | PT 570024 | 024 VDC 4 C/O 06A END. RÖLE | 10 | 5,08 € |
| 200-415 | PT 570048 | 048 VDC 4 C/O 06A END. RÖLE | 10 | 5,92 € |
| 200-420 | PT 570060 | 060 VDC 4 C/O 06A END. RÖLE | 10 | 6,90 € |
| 200-425 | PT 570110 | 110 VDC 4 C/O 06A END. RÖLE | 10 | 6,02 € |
| 200-426 | PT 570125 | 125 VDC 4 C/O 06A END. RÖLE | 10 | ☎ |
| 200-430 | PT 570220 | 220 VDC 4 C/O 06A END. RÖLE | 10 | 7,15 € |
| 200-435 | PT 570512 | 012 VAC 4 C/O 06A END. RÖLE | 10 | 6,02 € |
| 200-440 | PT 570524 | 024 VAC 4 C/O 06A END. RÖLE | 10 | 5,30 € |
| 200-445 | PT 570548 | 048 VAC 4 C/O 06A END. RÖLE | 10 | 7,04 € |
| 200-450 | PT 570560 | 060 VAC 4 C/O 06A END. RÖLE | 10 | 7,04 € |
| 200-455 | PT 570615 | 115 VAC 4 C/O 06A END. RÖLE | 10 | 6,02 € |
| 200-460 | PT 570730 | 230 VAC 4 C/O 06A END. RÖLE | 10 | 5,43 € |
| 200-411 | PT 570L24 | 024 VDC 4 C/O 06A END. RÖLE LEDLİ | 10 | 6,02 € |
| 200-461 | PT 570T30 | 230 VAC 4 C/O 06A END. RÖLE LEDLİ | 10 | 6,32 € |



| PT SERİSİ PCB RÖLELER | | | | |
|------------------------------|-----------|-------------------------------------|----|--------|
| 200-240 | PT 271012 | 012 VDC 2 C/O 12A END. RÖLE PCB TİP | 10 | 5,80 € |
| 200-380 | PT 371024 | 024 VDC 3 C/O 10A END. RÖLE PCB TİP | 10 | 5,90 € |
| 200-465 | PT 571012 | 012 VDC 4 C/O 06A END. RÖLE PCB TİP | 10 | 5,90 € |
| 200-470 | PT 571024 | 024 VDC 4 C/O 06A END. RÖLE PCB TİP | 10 | 5,95 € |
| 200-471 | PT 571110 | 110 VDC 4 C/O 06A END. RÖLE PCB TİP | 10 | 6,70 € |
| 200-472 | PT 571220 | 220 VDC 4 C/O 06A END. RÖLE PCB TİP | 10 | 7,25 € |



| PTF SERİSİ GÜÇ RÖLELERİ (2 x 15 A) | | | | |
|---|-----------|-----------------------------------|----|--------|
| 300-020 | PTF 20524 | 024 VAC 2 C/O 15A END. GÜÇ RÖLESİ | 10 | 6,60 € |
| 300-931 | YPT 789F0 | PTF RÖLE SOKETİ | 10 | 4,50 € |

4 pole

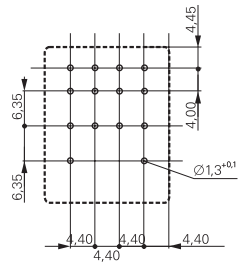

3 pole

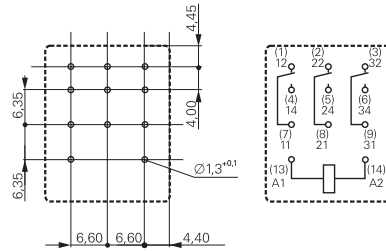

2 pole

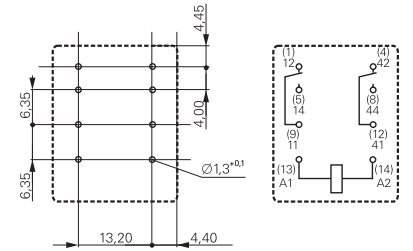

Dimensions

Solder- and plug-in terminals (standard version)

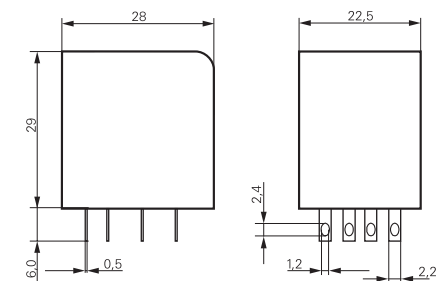

protection diode+LED

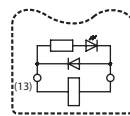

LED

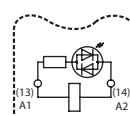

PCB version

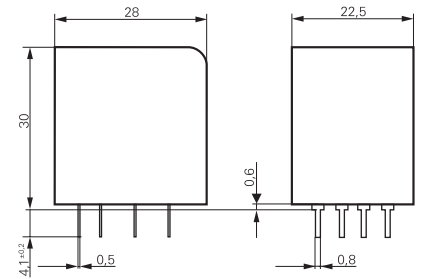

RÖLE AKSESUARLARI

| SİP NO | TİPİ | AÇIKLAMA | PAKET MİKTARI | FİYAT |
|------------------------------------|-----------|--|---------------|--------|
| PT SERİSİ RÖLE AKSESUARLARI | | | | |
| 219-010 | PT 78720 | 08 PIN RAY TİPİ SOKET VİDALI BAĞLANTI (2 C/O PT RÖLE İÇİN) | 10 | 3,08 € |
| 219-100 | YPT 78702 | 08 PIN RAY TİPİ SOKET VİDALI BAĞLANTI (2 C/O PT RÖLE İÇİN) | 10 | 2,99 € |
| 219-030 | PT 78730 | 11 PIN RAY TİPİ SOKET VİDALI BAĞLANTI (3 C/O PT RÖLE İÇİN) | 10 | 3,08 € |
| 219-050 | PT 78740 | 14 PIN RAY TİPİ SOKET VİDALI BAĞLANTI (2-4 C/O PT RÖLE İÇİN) | 10 | 3,08 € |
| 219-110 | YPT 78704 | 14 PIN RAY TİPİ SOKET VİDALI BAĞLANTI (2-4 C/O PT RÖLE İÇİN) | 10 | 2,99 € |
| 219-250 | PT 7872P | 08 PIN RAY TİPİ SOKET YAY BAĞLANTILI (2 C/O PT RÖLE İÇİN) | 10 | 3,08 € |
| 219-270 | PT 7874P | 14 PIN RAY TİPİ SOKET YAY BAĞLANTILI (2-4 C/O PT RÖLE İÇİN) | 10 | 4,60 € |
| 219-200 | PT 78603 | 11 PIN PCB TİPİ SOKET (3 C/O RÖLE İÇİN) | 25 | 1,75 € |
| 219-211 | YPT 78604 | 14 PIN PCB TİPİ SOKET (4 C/O RÖLE İÇİN) | 25 | 1,75 € |
| 219-310 | PT 16017 | KLİPS (YPT 78702-704 İÇİN) | 10 | 0,45 € |
| 219-320 | PT 17016 | KLİPS (78720-730-740 İÇİN) TUTUCU TİP | 10 | 0,45 € |
| 219-325 | PT 17024 | KLİPS (78720-730-740 İÇİN) TUTUCU-SÖKÜCÜ TİP | 10 | 0,58 € |
| 219-340 | PT 28800 | KLİPS (78720-730-740 İÇİN) METAL | 10 | 0,54 € |
| 219-400 | PT 16040 | ETİKET (YPT 78702-704 İÇİN) | 10 | 0,18 € |
| 219-410 | PT 17040 | ETİKET (78720-730-740 İÇİN) | 10 | 0,18 € |



| LED VE KORUMA MODÜLLERİ (RT SERİSİ SOKETLER İÇİN) | | | | |
|--|------------|---|----|--------|
| 120-011 | PTM L0 024 | 006-024 VDC LM 18 LED +KORUMA DİODU (A1+/A2-) | 10 | 2,40 € |
| 120-021 | PTM L0 524 | 006-024 VAC LM 07 LED MODÜLÜ | 10 | 2,40 € |
| 120-026 | PTM L0 110 | 048-110 VDC LM 20 LED +KORUMA DİODU (A1+/A2-) | 10 | 2,50 € |
| 120-031 | PTM L0 730 | 110-230 VAC LM 06 LED MODÜLÜ | 10 | 2,50 € |
| 120-040 | PTM T0 0A0 | 006-220 VDC EM 09 KORUMA DİODU A1 + / A2 - | 10 | 2,20 € |
| 120-046 | PTM V0 524 | 024 VAC LM 04 VARİSTÖR MODÜLÜ | 10 | 2,40 € |
| 120-051 | PTM V0 730 | 230 VAC LM 05 VARİSTÖR MODÜLÜ | 10 | 2,40 € |
| 120-060 | PTM U0 524 | 006-060 VAC RC KORUMA MODÜLÜ | 10 | 2,50 € |
| 120-063 | PTM U0 730 | 110-230 VAC RC KORUMA MODÜLÜ | 10 | 2,50 € |



| RTL LED VE KORUMA MODÜLLERİ (YRT SERİSİ SOKETLER İÇİN) | | | | |
|---|------------|--|----|--------|
| 120-100 | RTL M0 024 | 006-024 VDC LED+KORUMA DİODU (A1+/A2-) | 20 | 2,40 € |
| 120-103 | RTL M0 048 | 024-060 VDC LED+KORUMA DİODU (A1+/A2-) | 20 | 2,40 € |
| 120-105 | RTL M0 524 | 024-060 VAC LED MODÜLÜ | 20 | 2,40 € |
| 120-104 | RTL M0 110 | 110-230 VDC LED+KORUMA DİODU (A1+/A2-) | 20 | 2,50 € |
| 120-110 | RTL M0 730 | 110-230 VAC LED MODÜLÜ | 20 | 2,50 € |
| 120-300 | RPM U0 548 | 024-048 VAC RC KORUMA MODÜLÜ | 20 | 2,50 € |
| 120-310 | RPM U0 730 | 110-230 VAC RC KORUMA MODÜLÜ | 20 | 2,50 € |
| 120-320 | RPM T0 0A0 | KORUMA DİODU 1N4007 (A1+/A2-) | 20 | 2,20 € |

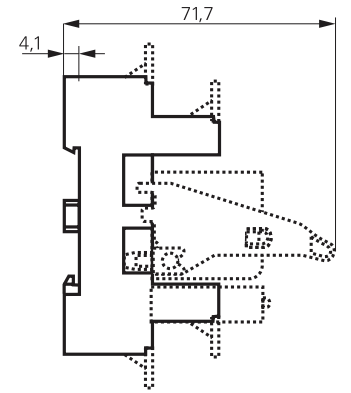
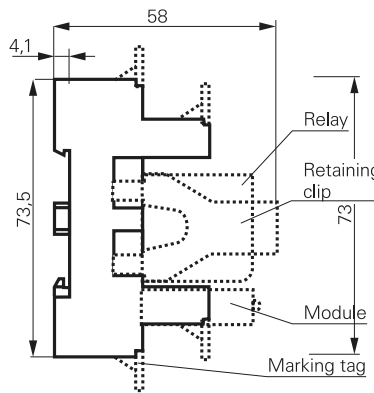
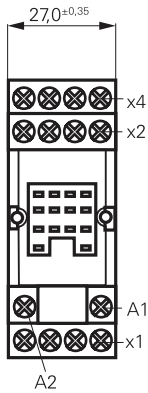

PT17016

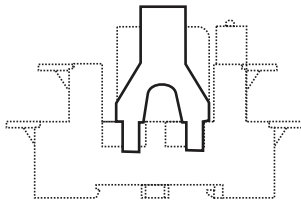

PT17024

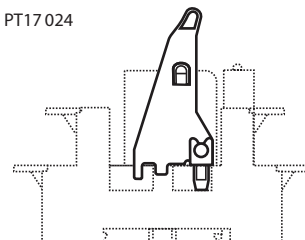

RÖLELER

| SİP NO | TİPİ | AÇIKLAMA | PAKET MİKTARI | FİYAT |
|--|-----------|--|---------------|--------|
| MT SERİSİ ENDÜSTRİYEL RÖLELER (TEST BUTONLU - YUVARLAK PİNLİ) | | | | |
| 210-210 | MT 221024 | 024 VDC 2 C/O 10A END. RÖLE | 25 | 6,95 € |
| 210-250 | MT 226230 | 230 VAC 2 C/O 10A END. RÖLE | 25 | 7,75 € |
| 210-305 | MT 321012 | 012 VDC 3 C/O 10A END. RÖLE | 25 | 7,25 € |
| 210-310 | MT 321024 | 024 VDC 3 C/O 10A END. RÖLE | 25 | 7,25 € |
| 210-315 | MT 321048 | 048 VDC 3 C/O 10A END. RÖLE | 25 | 8,70 € |
| 210-316 | MT 321060 | 060 VDC 3 C/O 10A END. RÖLE | 25 | ☎ |
| 210-325 | MT 321110 | 110 VDC 3 C/O 10A END. RÖLE | 25 | 8,50 |
| 210-328 | MT 321125 | 125 VDC 3 C/O 10A END. RÖLE | 25 | ☎ |
| 210-335 | MT 321220 | 220 VDC 3 C/O 10A END. RÖLE | 25 | ☎ |
| 210-360 | MT 326024 | 024 VAC 3 C/O 10A END. RÖLE | 25 | 7,60 € |
| 210-365 | MT 326048 | 048 VAC 3 C/O 10A END. RÖLE | 25 | 7,60 € |
| 210-370 | MT 326060 | 060 VAC 3 C/O 10A END. RÖLE | 25 | ☎ |
| 210-375 | MT 326115 | 115 VAC 3 C/O 10A END. RÖLE | 25 | 8,40 € |
| 210-380 | MT 326230 | 230 VAC 3 C/O 10A END. RÖLE | 25 | 7,90 € |
| 210-340 | MT 323024 | 024 VDC 3 C/O 10A END. RÖLE LEDLİ | 25 | ☎ |
| 210-350 | MT 3230C4 | 024 VDC 3 C/O 10A END. RÖLE LED+KORUMA DİODU | 25 | ☎ |
| 210-385 | MT 328024 | 024 VAC 3 C/O 10A END. RÖLE LEDLİ | 25 | ☎ |
| 210-376 | MT 328115 | 115 VAC 3 C/O 10A END. RÖLE LEDLİ | 25 | ☎ |
| 210-390 | MT 328230 | 230 VAC 3 C/O 10A END. RÖLE LEDLİ | 25 | ☎ |



| | | | | |
|------------------------------------|-----------|--|----|--------|
| MT SERİSİ RÖLE AKSESUARLARI | | | | |
| 220-030 | YMT 78755 | 08 PIN RAY TİPİ SOKET (2 C/O MT RÖLE İÇİN) | 10 | 2,99 € |
| 220-040 | YMT 78750 | 11 PIN RAY TİPİ SOKET (3 C/O MT RÖLE İÇİN) | 10 | 2,99 € |
| 220-020 | MT 78750 | 11 PIN RAY TİPİ SOKET (3 C/O MT RÖLE İÇİN) | 10 | 3,08 € |
| 220-100 | MT 78740 | 11 PIN RAY TİPİ SOKET (MODÜL TAKILIR) | 10 | 5,20 € |
| 220-181 | MT 78613 | 11 PIN PCB TİPİ SOKET (3 C/O RÖLE İÇİN) | 10 | 2,90 € |
| 220-120 | MT 28800 | METAL SOKET KLİPSİ | 10 | 0,85 € |
| 220-205 | MTML0024 | 024 AC/DC LED MODÜLÜ | | ☎ |
| 220-215 | MTML0730 | 110-230 AC/DC LED MODÜLÜ | | ☎ |
| 220-200 | MTMT00A0 | KORUMA MODÜLÜ 1N4007 | | ☎ |
| 220-210 | MTMFOW00 | MULTİ FONKSİYON ZAMAN MODÜLÜ | | ☎ |



| | | | | |
|--|-----------|--|----|---|
| RM SERİSİ GÜÇ RÖLELERİ (TEST BUTONLU) | | | | |
| 300-100 | RM 232024 | 024 VDC 2 C/O 16A SOKET MONTAJLI | 25 | ☎ |
| 300-105 | RM 232524 | 024 VAC 2 C/O 16A SOKET MONTAJLI | 25 | ☎ |
| 300-110 | RM 232730 | 230 VAC 2 C/O 16A SOKET MONTAJLI | 25 | ☎ |
| 300-150 | RM 732024 | 024 VDC 3 C/O 16A SOKET MONTAJLI | 25 | ☎ |
| 300-155 | RM 732524 | 024 VAC 3 C/O 16A SOKET MONTAJLI | 25 | ☎ |
| 300-160 | RM 732615 | 115 VAC 3 C/O 16A SOKET MONTAJLI | 25 | ☎ |
| 300-170 | RM 732730 | 230 VAC 3 C/O 16A SOKET MONTAJLI | 25 | ☎ |
| RM SERİSİ GÜÇ RÖLE AKSESUARI | | | | |
| 300-920 | RM 78705 | RAY TİP SOKET RM232- RM732 SERİLERİ İÇİN | 25 | ☎ |

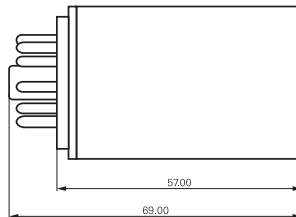
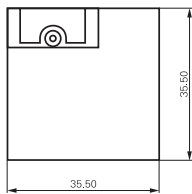
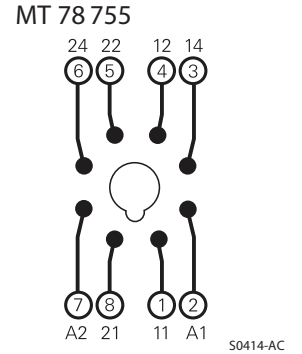
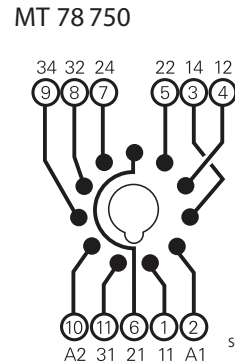
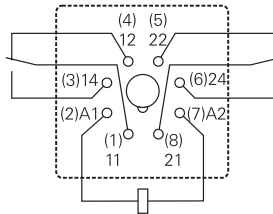
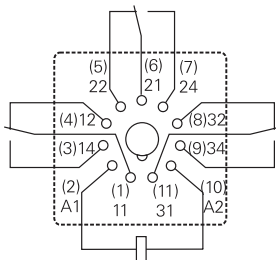

RÖLELER

| SİP NO | TİPİ | AÇIKLAMA | PAKET MİKTARI | FİYAT |
|--|--------------------------|--|---------------|---------|
| KORUMA RÖLELERİ | | | | |
| 305-100 | SR4 D4 024 | 024 VDC 2NO/2NC 08A KORUMA RÖLESİ | 10 | 25,00 € |
| 305-110 | SR4 M4 024 | 024 VDC 3NO/1NC 08A KORUMA RÖLESİ | 10 | 25,00 € |
| 305-040 | V23050-A1024-A533 | 024 VDC 3NO/3NC 08A KORUMA RÖLESİ | 10 | 35,00 € |
| 305-050 | V23050-A1024-A542 | 024 VDC 4NO/2NC 08A KORUMA RÖLESİ | 10 | 35,00 € |
| RE SERİSİ MİNYATÜR RÖLELER (200 mW) | | | | |
| 400-010 | RE 030005 | 005 VDC 1 N/O 06A MİNİ PCB RÖLE | 25 | 2,04 € |
| 400-030 | RE 030012 | 012 VDC 1 N/O 06A MİNİ PCB RÖLE | 25 | 2,04 € |
| 400-050 | RE 030024 | 024 VDC 1 N/O 06A MİNİ PCB RÖLE | 25 | 2,04 € |
| PE SERİSİ MİNYATÜR RÖLELER (200 mW) | | | | |
| 401-010 | PE 014005 | 005 VDC 1 C/O 05A MİNİ PCB RÖLE | 25 | 2,15 € |
| 401-020 | PE 014012 | 012 VDC 1 C/O 05A MİNİ PCB RÖLE | 25 | 2,15 € |
| 401-030 | PE 014024 | 024 VDC 1 C/O 05A MİNİ PCB RÖLE | 25 | 2,15 € |
| RY SERİSİ MİNYATÜR RÖLELER | | | | |
| 800-922 | RY 611005 | 005 VDC 1 C/O 08A PCB RÖLE 3.2 mm | 20 | 2,15 € |
| 402-040 | RY 211012 | 012 VDC 1 C/O 08A PCB RÖLE 3.2 mm | 20 | 2,15 € |
| 402-050 | RY 211024 | 024 VDC 1 C/O 08A PCB RÖLE 3.2 mm | 20 | 2,15 € |
| 402-066 | RY 531024 | 024 VDC 1 N/O 08A PCB RÖLE 5.0 mm | 20 | 2,15 € |
| TELEKOM RÖLELER | | | | |
| 410-015 | V23079-A2008-B301 | 003 VDC 2 C/O 05A TELEKOM RÖLE 140 mW | 50 | 1,73 € |
| 410-006 | V23079-A2001-B301 | 005 VDC 2 C/O 05A TELEKOM RÖLE 140 mW | 50 | 1,73 € |
| 410-020 | V23105-A5501-A201 | 005 VDC 2 C/O 03A TELEKOM RÖLE 500 mW | 25 | 1,73 € |
| 410-030 | V23105-A5502-A201 | 006 VDC 2 C/O 03A TELEKOM RÖLE 500 mW | 25 | 1,73 € |
| 410-070 | V23105-A5503-A201 | 012 VDC 2 C/O 03A TELEKOM RÖLE 500 mW | 25 | 1,73 € |
| 410-080 | V23105-A5505-A201 | 024 VDC 2 C/O 03A TELEKOM RÖLE 500 mW | 25 | 1,73 € |
| 410-090 | V23105-A5507-A201 | 048 VDC 2 C/O 03A TELEKOM RÖLE 500 mW | 25 | 1,73 € |
| 410-091 | V23105-A5305-A201 | 024 VDC 2 C/O 03A TELEKOM RÖLE 200 mW | 25 | 1,73 € |
| OEG RÖLELER | | | | |
| 430-021 | OJ-SS-112LMH2,005 | 012 VDC 1 N/O 08A MİNİ PCB RÖLE 200 mW | 100 | 1,32 € |
| 430-030 | OJE-SS-124DM | 024 VDC 1 N/O 05A MİNİ PCB RÖLE 450 mW | 100 | 1,32 € |
| 430-038 | PCJ-112D3M | 012 VDC 1 N/O 03A MİNİ PCB RÖLE 200 mW | 100 | 1,32 € |
| 800-620 | EJ05-1A4-D024-F | 024 VDC 1 N/O 05A MİNİ PCB RÖLE 200 mW | 100 | 1,32 € |
| 430-070 | PCH-105L2M,000 | 005 VDC 1 N/O 05A MİNİ PCB RÖLE 200 mW | 100 | 1,45 € |
| 430-073 | PCH-112L2M,000 | 012 VDC 1 N/O 05A MİNİ PCB RÖLE 200 mW | 100 | 1,45 € |
| 430-074 | PCH-124L2M,000 | 024 VDC 1 N/O 05A MİNİ PCB RÖLE 200 mW | 100 | 1,45 € |
| 430-071 | PCH-112D2H.000 | 012 VDC 1 C/O 05A MİNİ PCB RÖLE 400 mW | 100 | 1,45 € |
| KÜP RÖLELER | | | | |
| 430-205 | T73-12VDC | 012 VDC 1 C/O 10A KÜP RÖLE | 25 | 0,45 € |
| 430-206 | T73-24VDC | 024 VDC 1 C/O 10A KÜP RÖLE | 25 | 0,45 € |
| 430-060 | CHW-S-105DC2 | 005 VDC 1 C/O 10A KÜP RÖLE | 50 | 0,65 € |
| 430-061 | CHW-S-112DC2 | 012 VDC 1 C/O 10A KÜP RÖLE | 50 | 0,65 € |
| 430-062 | CHW-S-124DC2 | 024 VDC 1 C/O 10A KÜP RÖLE | 50 | 0,65 € |
| OTOMOTİV RÖLELERİ | | | | |
| 315-210 | STR-12 | 012 VDC 1 C/O 30A FASTON TİP OTO RÖLESİ BRAKETLİ | 20 | 1,90 € |
| 315-215 | STR-24 | 024 VDC 1 C/O 30A FASTON TİP OTO RÖLESİ BRAKETLİ | 20 | 1,90 € |
| 315-077 | V23234-A0001-X040-EV-100 | 012 VDC 1 C/O 35A FASTON TİP OTO RÖLESİ | 20 | 3,25 € |
| 315-081 | V23234-A0004-X055-EV-100 | 024 VDC 1 C/O 35A FASTON TİP OTO RÖLESİ | 20 | 3,25 € |
| 430-062 | CHW-S-124DC2 | 024 VDC 1 C/O 10A KÜP RÖLE | 50 | 0,65 € |

SUPERSEAL KONNEKTÖRLER

| SİP NO | TİPİ | AÇIKLAMA | PAKET MİKTARI | FİYAT |
|------------------------------------|----------|-----------------------------|---------------|--------|
| SUPERSEAL TERMİNAL YUVALARI | | | | |
| 780-010 | 282079-2 | 1 PIN DIŞI TERMİNAL YUVASI | 100 | 0,50 € |
| 780-011 | 282080-1 | 2 PIN DIŞI TERMİNAL YUVASI | 100 | 0,52 € |
| 780-012 | 282087-1 | 3 PIN DIŞI TERMİNAL YUVASI | 100 | 0,62 € |
| 780-013 | 282088-1 | 4 PIN DIŞI TERMİNAL YUVASI | 100 | 0,76 € |
| 780-014 | 282089-1 | 5 PIN DIŞI TERMİNAL YUVASI | 100 | 0,82 € |
| 780-015 | 282090-1 | 6 PIN DIŞI TERMİNAL YUVASI | 100 | 1,48 € |
| 780-030 | 282103-1 | 1 PIN ERKEK TERMİNAL YUVASI | 100 | 0,52 € |
| 780-031 | 282104-1 | 2 PIN ERKEK TERMİNAL YUVASI | 100 | 0,56 € |
| 780-032 | 282105-1 | 3 PIN ERKEK TERMİNAL YUVASI | 100 | 0,62 € |
| 780-033 | 282106-1 | 4 PIN ERKEK TERMİNAL YUVASI | 100 | 0,76 € |
| 780-034 | 282107-1 | 5 PIN ERKEK TERMİNAL YUVASI | 100 | 0,82 € |
| 780-035 | 282108-1 | 6 PIN ERKEK TERMİNAL YUVASI | 100 | 1,03 € |



| SİP NO | TİPİ | AÇIKLAMA | PAKET MİKTARI | FİYAT |
|------------------------------|----------|------------------------------|---------------|--------|
| SUPERSEAL TERMİNALLER | | | | |
| 780-020 | 282403-1 | 0.35-0.50 mm2 DIŞI TERMİNAL | 1.000 | 0,08 € |
| 780-021 | 282110-1 | 0.75-1.50 mm2 DIŞI TERMİNAL | 1.000 | 0,10 € |
| 780-022 | 282466-1 | 1.50-2.50 mm2 DIŞI TERMİNAL | 1.000 | 0,12 € |
| 780-040 | 282404-1 | 0.35-0.50 mm2 ERKEK TERMİNAL | 1.000 | 0,06 € |
| 780-041 | 282109-1 | 0.75-1.50 mm2 ERKEK TERMİNAL | 1.000 | 0,08 € |
| 780-042 | 282465-1 | 1.50-2.50 mm2 ERKEK TERMİNAL | 1.000 | 0,10 € |



| SİP NO | TİPİ | AÇIKLAMA | PAKET MİKTARI | FİYAT |
|------------------------------------|----------|---------------------|---------------|--------|
| SUPERSEAL KORUYUCU KAPAKLAR | | | | |
| 780-050 | 880810-1 | 2 Lİ KORUYUCU KAPAK | 1.000 | 1,44 € |
| 780-051 | 880811-2 | 3 LÜ KORUYUCU KAPAK | 1.000 | 1,54 € |
| 780-052 | 493581-1 | 4 LÜ KORUYUCU KAPAK | 1.000 | 1,60 € |



| SİP NO | TİPİ | AÇIKLAMA | PAKET MİKTARI | FİYAT |
|---|----------|---------------------|---------------|--------|
| SUPERSEAL SIZDIRMAZLIK CONTALARI | | | | |
| 780-060 | 281934-4 | 0.35-0.50 mm2 CONTA | 1.000 | 0,05 € |
| 780-061 | 281934-2 | 0.75-1.50 mm2 CONTA | 1.000 | 0,05 € |
| 780-062 | 281934-3 | 1.50-2.50 mm2 CONTA | 1.000 | 0,05 € |
| 780-063 | 282081-1 | KÖR TAPA | 1.000 | 0,05 € |



| SİP NO | TİPİ | AÇIKLAMA | PAKET MİKTARI | FİYAT |
|------------------------------|--------------------|------------------------|---------------|-------|
| SUPERSEAL EL ALETLERİ | | | | |
| 780-075 | 9-1579007-1 | PIN ÇIKARMA ALETİ | 1 | ☎ |
| 780-070 | 539635-1 +539773-2 | TERMİNAL SIKMA PENSESİ | 1 | ☎ |

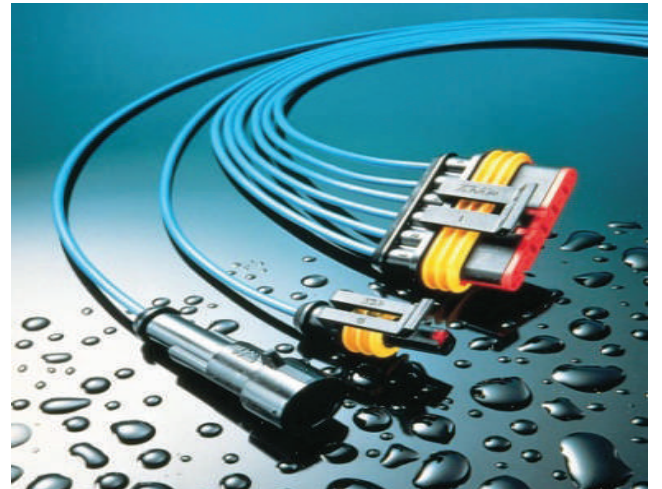
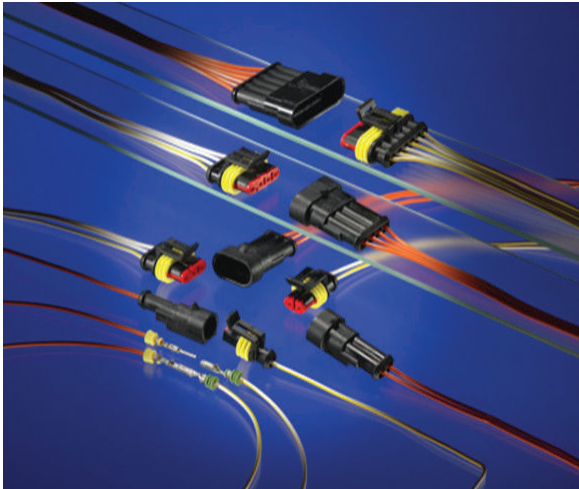

PANO AKSESUARLARI

| SİP NO | TİPİ | AÇIKLAMA | PAKET MİKTARI | FİYAT |
|----------------------|---------|------------------------|---------------|---------|
| KOPRÜ DİODLAR | | | | |
| 700-010 | KBPC35A | 35 A 1000 V KÖPRÜ DİOD | 50 | 0,90 \$ |
| 700-020 | KBPC50A | 50 A 1000 V KÖPRÜ DİOD | 50 | 1,47 \$ |



PANO AKSESUARLARI

| | | | | |
|---------|---------|---|-----|----------|
| 610-704 | PC-050G | PROJE CEBİ A5 GRİ | 20 | 3,90 TL |
| 610-705 | PC-050S | PROJE CEBİ A5 ŞEFFAF | 20 | 3,90 TL |
| 610-710 | PC-100G | PROJE CEBİ A4 GRİ | 20 | 4,90 TL |
| 610-720 | PC-100S | PROJE CEBİ A4 ŞEFFAF | 20 | 4,90 TL |
| 610-750 | EK-35 | ESNEK KABLO KANALI 25cm ÇAP : 35 mm (EKLENEBİLİR) | 200 | 2,50 TL |
| 610-800 | LV-10 | 110-230 VAC PANO AYDINLATMA ARMATÜRÜ | 1 | 19,80 \$ |



TERMOSTAT VE HİDROSTATLAR

| | | | | |
|---------|---------------|---|---|----------|
| 610-010 | TY-90-B3 | 230 VAC 10A 1C/O 0-30 DERECE ODA TERMOSTATI (CAMPINI) | 1 | 11,50 € |
| 610-500 | RT 802 | 230 VAC 10A ELEKTRONİK TERMOSTAT (-20 / + 120) | 1 | 15,00 € |
| 610-600 | NTC PROB | NTC PROB 1.5 METRE | 1 | 3,00 € |
| 610-031 | JWT-6011R | 230 AC 1 N/C 10A PANO TERMOSTATI (KIRMIZI) ISITICI | 1 | 6,00 \$ |
| 610-041 | JWT-6011F | 230 AC 1 N/O 10A PANO TERMOSTATI (MAVİ) FAN | 1 | 6,00 \$ |
| 610-046 | JWT-6012 | 230 AC 1 N/O + 1N/C İKİLİ TERMOSTAT (KIRMIZI + MAVİ) | 1 | 16,00 \$ |
| 610-030 | TH-H | 230 AC 1 N/C 10A PANO TERMOSTATI (KIRMIZI) ISITICI | 1 | 9,00 € |
| 610-040 | TH-K | 230 AC 1 N/O 10A PANO TERMOSTATI (MAVİ) FAN | 1 | 9,00 € |
| 610-050 | HY / WE | 230 AC 1 C/O 10A MEKANİK HİDROSTAT (% 10- % 80) | 1 | 45,00 € |
| 610-100 | HY / TH COMBİ | 230 AC 1C/O 10A MEKANİK HİDROSTAT + 1 NC TERMOSTAT | 1 | 75,00 € |



RO/SE PANO ISITICILARI

| | | | | |
|---------|-----------|--|---|----------|
| 620-010 | SD/S1-025 | 230 AC 025W PANO ISITICI 075 x 060 x 045 | 1 | 42,00 € |
| 620-020 | SD/S3-050 | 230 AC 050W PANO ISITICI 075 x 116 x 045 | 1 | 46,00 € |
| 620-030 | SD/S4-100 | 230 AC 100W PANO ISITICI 075 x 166 x 045 | 1 | 49,00 € |
| 620-040 | SD/S5-150 | 230 AC 150W PANO ISITICI 075 x 216 x 045 | 1 | 68,00 € |
| 620-050 | SD/S6-250 | 230 AC 250W PANO ISITICI 075 x 316 x 045 | 1 | 78,00 € |
| 620-100 | HG-VARIO | 230 AC 250W PANO ISITICI 080 x 110 x 188 (FANLI) | 1 | 134,00 € |



HİLKAR PANO ISITICILARI

| | | | | |
|---------|---------|--|---|----------|
| 617-020 | RSD-50 | 230 AC 050 W PANO ISITICI PTC TİPİ 70 X 070 X 50 | 1 | 26,00 \$ |
| 617-030 | RSD-100 | 230 AC 100 W PANO ISITICI PTC TİPİ 70 X 140 X 50 | 1 | 34,00 \$ |
| 615-005 | HR 050 | 230 AC 050 W PANO ISITICI 40 X 135 X 42.5 | 1 | 48,00 TL |
| 615-010 | HR 100 | 230 AC 100 W PANO ISITICI 40 X 135 X 42.5 | 1 | 48,00 TL |
| 615-020 | HRY 050 | 230 AC 050 W PANO ISITICI YASSI TİP (3M KABLOLU) | 1 | 24,00 € |
| 615-030 | HRY 100 | 230 AC 100 W PANO ISITICI YASSI TİP (3M KABLOLU) | 1 | 24,00 € |



FANLAR

| SİP NO | TİPİ | AÇIKLAMA | PAKET MİKTARI | FİYAT |
|-----------------------------|-------------|---------------------------------|---------------|----------|
| RTK SERİSİ DC FANLAR | | | | |
| 600-010 | 080-080-025 | 012 DC FAN 012 VDC 055 M3/h FAN | 100 | 2,50 \$ |
| 600-011 | 080-080-025 | 024 DC FAN 024 VDC 065 M3/h FAN | 100 | 2,50 \$ |
| 600-015 | 120-120-025 | 012 DC FAN 012 VDC 122 M3/h FAN | 100 | 6,00 \$ |
| 600-016 | 120-120-025 | 024 DC FAN 024 VDC 125 M3/h FAN | 100 | 6,00 \$ |
| 600-017 | 120-120-038 | 012 DC FAN 012 VDC 140 M3/h FAN | 40 | 6,00 \$ |
| 600-050 | 120-120-038 | 024 DC FAN 024 VDC 140 M3/h FAN | 40 | 6,00 \$ |
| 600-055 | 120-120-038 | 048 DC FAN 048 VDC 150 M3/h FAN | 40 | 9,80 \$ |
| 600-094 | 172-150-050 | 012 DC FAN 012 VDC 262 M3/h FAN | 12 | 18,00 \$ |
| 600-091 | 172-150-050 | 024 DC FAN 024 VDC 270 M3/h FAN | 12 | 18,00 \$ |

| | | | | |
|-----------------------------|-------------|------------------------------------|----|----------|
| RTK SERİSİ AC FANLAR | | | | |
| 600-020 | 080-080-025 | 230 AC FAN 230 VAC 026 M3/h FAN | 50 | 5,00 \$ |
| 600-030 | 080-080-038 | 230 AC FAN 230 VAC 039 M3/h FAN | 50 | 5,00 \$ |
| 600-037 | 108-108-026 | 230 AC FAN 230 VAC 051 M3/h FAN | 50 | 6,00 \$ |
| 600-040 | 120-120-025 | 230 AC FAN 230 VAC 065 M3/h FAN | 40 | 5,00 \$ |
| 600-060 | 120-120-038 | 110 AC FAN 110 VAC 153 M3/h FAN | 40 | 6,00 \$ |
| 600-070 | 120-120-038 | 230 AC FAN KBL230 VAC 153 M3/h FAN | 40 | 4,75 \$ |
| 600-071 | 120-120-038 | 230 AC FAN SKT230 VAC 153 M3/h FAN | 40 | 5,00 \$ |
| 600-080 | 120-120-038 | 230 AC FAN RLM230 VAC 153 M3/h FAN | 40 | 7,50 \$ |
| 600-097 | 172-150-050 | 110 AC FAN 230 VAC 270 M3/h FAN | 12 | 18,00 \$ |
| 600-090 | 172-150-050 | 230 AC FAN 230 VAC 270 M3/h FAN | 12 | 16,00 \$ |
| 600-096 | 172-163-050 | 230 AC FAN 230 VAC 270 M3/h FAN | 12 | 16,00 \$ |
| 600-100 | 200-200-060 | 230 AC FAN YUV230 VAC 300 M3/h FAN | 10 | 24,00 \$ |
| 600-130 | 225-225-080 | 230 AC FAN 230 VAC 1020 M3/h FAN | 1 | 80,00 \$ |
| 600-150 | 280-280-080 | 230 AC FAN 230 VAC 1850 M3/h FAN | | |



600-030



600-070



600-090



600-096



600-130



600-100

FAN FİLTRE VE SETLERİ

| SİP NO | TİPİ | AÇIKLAMA | PAKET MİKTARI | FİYAT |
|--------------------|----------|---|---------------|-----------|
| FAN SETLERİ | | | | |
| 602-110 | FS105-A1 | 230 VAC 030 M3/h FAN SETİ (105 x 105 x 055) BEJ R7032 | 1 | 9,00 \$ |
| 602-111 | FS105-A2 | 230 VAC 030 M3/h FAN SETİ (105 x 105 x 055) GRİ R7035 | 1 | 9,00 \$ |
| 602-210 | FS150-A1 | 230 VAC 100 M3/h FAN SETİ (150 x 150 x 060) BEJ R7032 | 1 | 9,50 \$ |
| 602-211 | FS150-A2 | 230 VAC 100 M3/h FAN SETİ (150 x 150 x 060) GRİ R7035 | 1 | 9,50 \$ |
| 602-310 | FS250-A1 | 230 VAC 190 M3/h FAN SETİ (250 x 250 x 075) BEJ R7032 | 1 | 38,00 \$ |
| 602-311 | FS250-A2 | 230 VAC 190 M3/h FAN SETİ (250 x 250 x 075) GRİ R7035 | 1 | 38,00 \$ |
| 602-320 | FS250-B1 | 230 VAC 200 M3/h FAN SETİ (250 x 250 x 110) BEJ R7032 DAVLUMBAZLI | 1 | 42,00 \$ |
| 602-321 | FS250-B2 | 230 VAC 200 M3/h FAN SETİ (250 x 250 x 110) GRİ R7035 DAVLUMBAZLI | 1 | 42,00 \$ |
| 602-350 | FS250-E1 | 230 VAC 780 M3/h FAN SETİ (250 x 250 x 110) BEJ R7032 | 1 | 100,00 \$ |
| 602-351 | FS250-E2 | 230 VAC 780 M3/h FAN SETİ (250 x 250 x 110) GRİ R7035 | 1 | 100,00 \$ |

| | | | | |
|-----------------------|----------|--|----|----------|
| FAN FİLTRELERİ | | | | |
| 601-110 | F105-A10 | 105 x 105 FAN FİLTRESİ BEJ R7032 | 10 | 3,50 TL |
| 601-120 | F105-A20 | 105 x 105 FAN FİLTRESİ GRİ R7035 | 10 | 3,50 TL |
| 601-210 | F150-A10 | 150 x 150 FAN FİLTRESİ BEJ R7032 | 10 | 4,30 TL |
| 601-220 | F150-A20 | 150 x 150 FAN FİLTRESİ GRİ R7035 | 10 | 4,30 TL |
| 601-230 | F150-A30 | 150 x 150 FAN FİLTRESİ SYH R9005 | 10 | 4,30 TL |
| 601-310 | F250-A10 | 250 X 250 FAN FİLTRESİ BEJ R7032 ÇAP:150 | 10 | 15,00 TL |
| 601-320 | F250-A20 | 250 X 250 FAN FİLTRESİ GRİ R7035 ÇAP:150 | 10 | 15,00 TL |
| 601-330 | F250-A30 | 250 X 250 FAN FİLTRESİ SYH R9005 ÇAP:150 | 10 | 15,00 TL |
| 601-411 | F250-A11 | 250 X 250 FAN FİLTRESİ BEJ R7032 ÇAP:210 | 10 | 15,00 TL |
| 601-421 | F250-A21 | 250 X 250 FAN FİLTRESİ GRİ R7035 ÇAP:210 | 10 | 15,00 TL |
| 601-431 | F250-A31 | 250 X 250 FAN FİLTRESİ SYH R9005 ÇAP:210 | 10 | 15,00 TL |
| 601-450 | F250-B10 | 250 X 250 FAN FİLTRESİ BEJ R7032 DERİN TİP | 10 | 18,00 TL |
| 601-460 | F250-B20 | 250 X 250 FAN FİLTRESİ GRİ R7032 DERİN TİP | 10 | 18,00 TL |

| | | | | |
|---------------------------|--------|---------------------------------|----|---------|
| FAN KORUMA TELLERİ | | | | |
| 601-910 | MK 080 | 080 X 080 METAL FAN KORUMA TELİ | 10 | 0,50 \$ |
| 601-915 | MK 120 | 120 X 120 METAL FAN KORUMA TELİ | 10 | 0,80 \$ |
| 601-925 | MK 172 | 172 X 172 METAL FAN KORUMA TELİ | 10 | 1,00 \$ |
| 601-930 | MK 200 | 225 X 225 METAL FAN KORUMA TELİ | 10 | 2,50 \$ |
| 901-932 | MK 280 | 280 X 280 METAL FAN KORUMA TELİ | | |

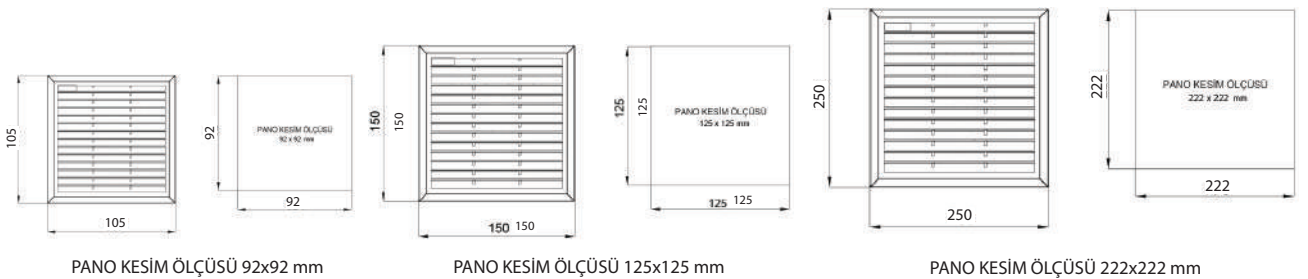
~ 30 m³ 602-110~ 100 m³ 602-210~ 780 m³ 602-350~ 200 m³ 602-320~ 190 m³ 602-310

GENEL ŞARTLAR

- Fiyatlarımızda önceden haber verilmeden deęişiklik yapma hakkımız saklıdır.
- Fiyatlarımıza KDV dahil deęildir.
- Döviz bazlı fiyatlarımızda fatura tarihindeki TCMB döviz satış fiyatları referans alınır.
- Sevkiyatlarımız standart ambalajlara göre yapılır.
- Nakliye ücreti alıcıya aittir.
- Firmamızın onayı alınmadan iade kabul edilmez.
- İadesi kabul edilen ürünlerin nakliyesi alıcıya aittir.
- Listemizde yer almayan ürünler için lütfen satış bölümümüz ile temas kurunuz.

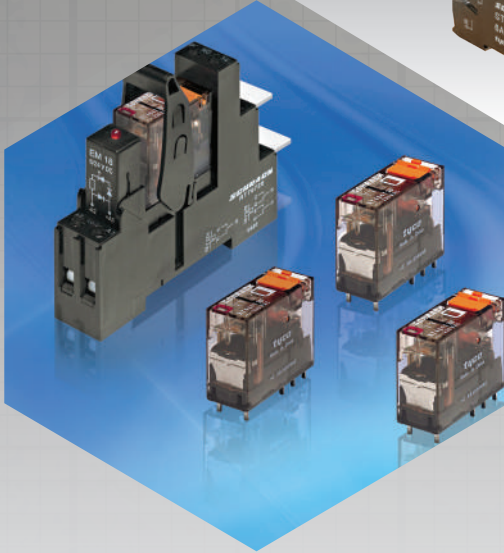
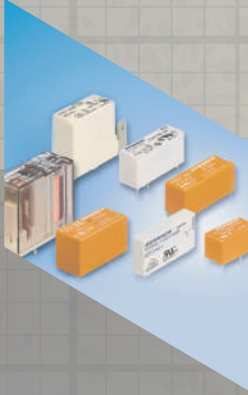

HUZUR ELEKTRİK ELEKTRONİK SAN.VE TİCARET LTD. ŞTİ.
MERKEZ : Perpa Ticaret Merkezi A Blok Kat:1-2-3 No: 9/0020
Okmeydanı - Şişli / İSTANBUL
Tel : 0212 320 65 65 Fax: 0212 210 03 14
DEPO: Gürsel Mah. Dünür Sk. No: 12 Kağıthane / İSTANBUL
huzur@huzurelektroteknik.com www.huzurelektroteknik.com

