

 **IZELTAS®**



 **YERLİ
ÜRETİM**

MAYIS / 2022
FİYAT KATALOĞU

İZELTAS®

TAKIM DOLAPLARI TAKIM ÇANTALARI VE ALET SETLERİ

TOOL TROLLEYS, TOOL BOXES AND
HAND TOOL SETS



Takim Dolapları
Tool Cabinets

Takim Çantaları
Tool Boxes

Servis Masaları
Service Tables

Alet Setleri
Tool Sets



İZELTAS YOUTUBE

**6 bölmeli sağlam ve dayanıklı
ABS plastik üst malzeme tabla**
Solid and resistant ABS top
cover with 6 divisions

**Merkezi kilit mandal sistemi
devrilme emniyet sistemi**
Central lock with an
anti-tilt system

Standart tutma sapı
Standard handle



**% 100
açılabilir raylar**
%100
extendable
slides

**Plastik köşe
koruma**
Plastic corner
guard

**2 sabit 2 hareketli
frenli tekerlek ø125mm.**
2 fixed, 2 swivel with
brake castor ø125 mm.

**Yüksek dayanımlı
elektrostatik toz boya**
High strength electrostatic
powder paint



8245 PREMIUM SERİSİ / PREMIUM SERIES

Premium Serisi Takım Dolabı (5-7 Çekmeceli)
Premium Series Workshop Trolley (5-7 Drawers)



✓ 6 bölmeli sağlam ve dayanıklı ABS plastik üst malzeme tabla.
● Resistant and solid top cover having 6 divisions



✓ %100 açılabilir teleskobik raylar.
● %100 extendable telescopic slides



✓ Merkezi kilit
✓ Mandal sistemi
✓ Devrilme emniyet sistemi
● Central lock
● Handgrip Lock system
● Anti tilt system



✓ 2 sabit, 2 hareketli frenli tekerlek ø 125mm
● 2 swivel castors with brake
2 fixed castors ø 125mm



✓ Standard tutma sapı
● Standard handle



✓ Plastik köşe koruma
● Plastic corner protection



✓ Yüksek dayanımlı elektrostatik toz boya.
● High strength electrostatic powder coating.



✓ Havluluk x1
Avadanlık x2 Aşılık x1
● Paper Roll Holder
x 1 Bottle & Tins Holder x2 Hanger x1

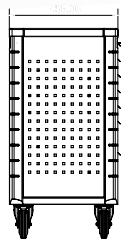
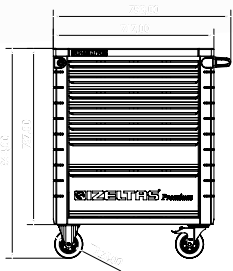



Ölçü/Size: 485x717x944 mm

Sacdan imal edilmiş, Fırın boya
Made of sheet metal, Electrostatic paint



IZELTAS YOUTUBE

KOD/CODE	ÇEKMECE DRAWERS				Kg	RENK COLORS	FİYAT TL/Ad
		400x548x63	400x548x132	400x548x202			
8245 32 1005	5	2X	1X	2X	64		7261,75
8245 32 1007	7	5X	1X	1X	70	RAL 9005 RAL 3020	9400,99
8245 00 7096 Dolu/Full 243 Parça/Pcs	7	5X	1X	1X			26005,25

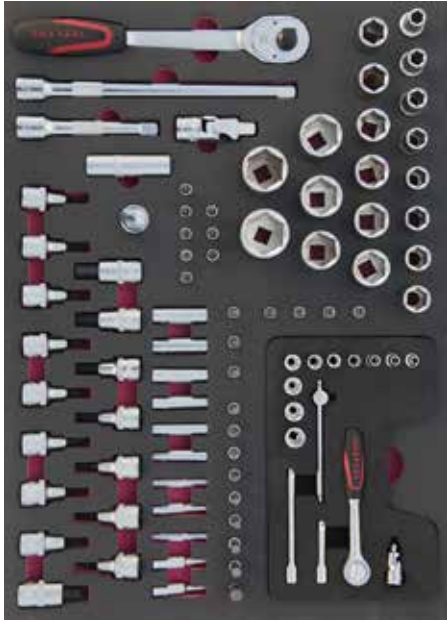
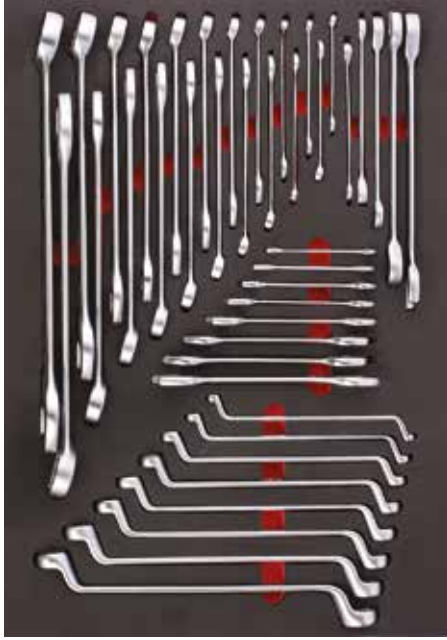

1. Premium Seri Çekmece/Drawer Kod / Code 8245001042

KOD CODE	İÇERİK CONTENTS	□	FIYAT TL/Ad
0100	İki Ağız Anahtar Kısa Boy D/E Open jaw wrenches Short Pattern 6x7-8x9-10x11-12x13-14x15-16x17-18x19-20x22	8	
0320	Kombine Anahtar Kısa Boy Combination wrenches Short Pattern 6-7-8-9-10-11-12-13-14-15-16-17-18-19-20-21-22-24-27-30-32	21	3210,15
0430	Yıldız Anahtar Ring Wrenches 6x7-8x9-10x11-12x13-14x15-16x17-18x19-20x22	8	
0340	Cırcır Kombine Anahtar / Combination Wrench With Ratchet 8-10-13-17-19	5	

2. Premium Seri Çekmece/Drawer Kod / Code 8245002094

KOD CODE	İÇERİK CONTENTS	□	FIYAT TL/Ad
1107	1/4" Lokmalı Allen Uçlar / Hexagonal Bits Socket 2,5 - 3 - 4 - 5 - 6 - 7 - 8 - 10	8	
1107	1/4" Lokmalı Torx Uç / Torx Bits Socket T8-T9-T10-T15-T20-T25-T27-T30-T40	9	
1107	1/4" Lokmalı Yıldız Uç / Phillips Bits Socket PH1-PH2-PH3	3	
1107	1/4" Lokmalı Düz Uç / Slotted Bits Socket 3 - 4 - 5,5 - 6,5	4	
1107	1/4" Altı Köşe Derin Lokma / Deep Socket Wrench 6 Point 4-5-5,5-6-7-8-9-10-11-12-13	11	
1113	1/2" Lokmalı Allen Uç / Hexagonal Bits Socket 5-6-7-8-10-12-14	7	
1113	1/2" Lokmalı Torx Uç / Torx Bits Socket T20-T25-T27-T30-T40-T45-T50-T55-T60	9	
1107	4 - 5 - 6 7 - 8 - 9 - 10 11 - 12 - 13 Altı Köşe Six Points 1/4" Altı Köşe Lokma Takımı / Socket Wrench Set 1/4" Cırcır kolu / Ratchet Handle	15	3525,80
	1/4" Mafsalsal / Universal Joint		
	1/4" T Kol / Sliding T Handle		
1113	1/4" Ara Kol / Extension Bar 50-100 mm		
	1/2" Buji Lokma Lastikli Spark Plug Socket With Rubber 16 mm	1	
1113	1/2" Lokma Takımı / Socket Wrench Set 1/2" Cırcır Kolu 32 Diş / Ratchet Handle 1/2" Mafsalsal / Universal Joint	24	
	1/2" T Kol Adaptör / Sliding T Handle Adapter		
	1/2" Ara Kol / Extension Bar 125-250 mm		

3. Premium Seri Çekmece/Drawer Kod / Code 8245003014

KOD CODE	İÇERİK CONTENTS	□	FIYAT TL/Ad
3700	Yan Keski Opak Seri / Side Cutting Pliers 160 mm	1	
3020	Kombine Pense Opak Seri / Combination Pliers 180 mm	1	
3220	Kargaburun Düz Uçlu Opak Seri / Nose Pliers Flat 180 mm	1	
4300	Opak Seri Düz Uçlu Tornavida / Screwdriver, Flat 3x80-5x125-7x150	3	
4320	Opak Seri Yıldız Uçlu Tornavida / Screwdriver, Phillips 3x60-4.5x80-6x100-8x150	4	1635,30
3301	Dış Segman Pensi Düz / Circlip Pliers, External Flat 140-180mm	2	
3321	İç Segman Pensi Düz / Circlip Pliers, Internal Flat 140-180mm	2	

4. Premium Seri Çekmece/Drawer Kod / Code 8245004043

KOD CODE	İÇERİK CONTENTS	☐	FİYAT TL/Ad
4770	Lokma Uçlu Tornavida / Nutspinner 6-7-8-9-10-13	6	
4910	Torx Allen Takım / Torx Key Wrench Set T9-T10-T15-T20-T25-T27-T30-T40	8	
4900	Allen Takımı 6 Köşe / Hex Key Wrench Set 2-2.5-3-3.5-4-5-6-7-8-9-10-12	12	1863,05
4906	Yuvarlak Başlı Uzun Allen Takımı / Hex key Wrench Ballpoint Long Pattern Set 1.5-2-2.5-3-4-5-6-8-10	9	
4920	T Tipi Allen Anahtar / T Type Hex Key Wrench 2.5-3-4-5-6-7-8-10	8	

5. Premium Seri Çekmece/Drawer Kod / Code 8245005043

KOD CODE	İÇERİK CONTENTS	☐	TL/Ad.
4565	Oto Elektrik Kontrol Kalemi Car Voltage Tester 135mm	1	
07415	Sıralı Tel Fırça 4 Sıralı / Hand Brush 4 Raws	1	
2400	Üniversal Fort Pense / Waterpump Pliers Universal 240 mm	1	
2500	Üniversal Ayarlı Pense Universal Grip 250 mm	1	
0600	Kurbağacık Anahtar / Adjustable Wrench 10"	1	
4780	Manyetik Bits Tutucu Tornavida / Screwdriver, Magnetic Bit Holder 6.3x120	1	
4800	31'li Bits Set (Plastik Kutulu) / Bits Set in plastic case	31	2016,85
4110	Düz Topaç Tornavida / Screwdriver, Stubby, Flat 6.5x25	1	
4130	Yıldız Topaç Tornavida / Screwdriver, Stubby, Phillips 6x25	1	
5500	Düz Keski Krom Flat Cold Chisel 150 mm	1	
5800	Tesviyeci Çekici Machinist's Hammer 300-1500 gr	2	
6350	Levye Oluklu / Tyre Lever 500 mm	1	

6. Premium Seri Çekmece/Drawer Kod / Code 8245006009

KOD CODE	İÇERİK CONTENTS	☐	FİYAT TL/Ad
1855	Mafsallı T Kol Lokma T- Handle Wrench with Universal Join 8-10-12-13-17-19	6	
6230	Gres Pompası Grease Gun 500cc	1	4353,20
06375	Ayarlı Yağ Filtre Sökeceği Adjustable Slot Type Oil Filter Wrench	1	
6225	Madeni Yağdanlık (Flexible Uçlu) Oiler With Flexible Spout 200cc	1	



8241 PRO SERİSİ / PRO SERIES

Pro Serisi Takım Dolabı (5-6-7-8 Çekmeceli)
Pro Series Workshop Trolley (5-6-7-8 Drawers)



✓ Merkezi kilit sistemi, mandal sistemi ve devrilme emniyet sistemi.
● Central lock system, handgrip lock system and antitilt system.



✓ Teleskobik rulmanlı kızaklar tüm çekmeceler %100 açılabilir.
● Telescopic slides which are %100 extendable.



✓ 8 bölmeli sağlam ve dayanıklı ABS plastik üst malzeme tabla.
● Durable ABS worktop with 8 divisions



✓ 2 sabit, 2 hareketli frenli tekerlek Ø 125mm
● 2 swivel castors with brake, 2 fixed castors Ø 125mm



✓ Yüksek dayanımlı elektrostatik toz boya.
● High strenght electrostatic powder coating



Ölçü/Size: 470x670x1007 mm

Sacdan imal edilmiş, Fırın boya
Made of sheet metal, Electrostatic paint

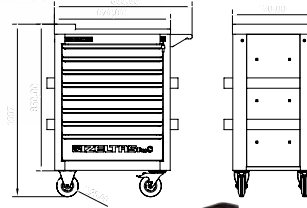

✓ Toplam 6 Adet yan ve arka avadanlık bölümleri.
● 6 tool holders



KOD/CODE	ÇEKMECE DRAWERS	35 kg	35 kg	35 kg	KG	RENK COLORS	FİYAT TL/Ad
		400x548x68	400x548x143	400x548x218			
8241 32 1005	5	1X	4X	--	59		7508,25
8241 32 1006	6	4X	1X	1X	62		8113,40
8241 32 1007	7	5X	2X	--	65		9587,95
8241 32 1008	8	7X	1X	--	67		10220,30
8241 32 2005	5	1X	4X	--	59		7508,25
8241 32 2006	6	4X	1X	1X	62		8113,40
8241 32 2007	7	5X	2X	--	65		9587,95
8241 32 2008	8	7X	1X	--	67		10220,30
8241 32 3005	5	1X	4X	--	59		7508,25
8241 32 3006	6	4X	1X	1X	62		8113,40
8241 32 3007	7	5X	2X	--	65		9587,95
8241 32 3008	8	7X	1X	--	67		10220,30
8241 00 1209 Dolu/Full 206 Parça/Pcs	8	7X	1X	--			22591,50

(*) İşaretili olan ürünler stoklarla sınırlıdır.
Limited with stocks.

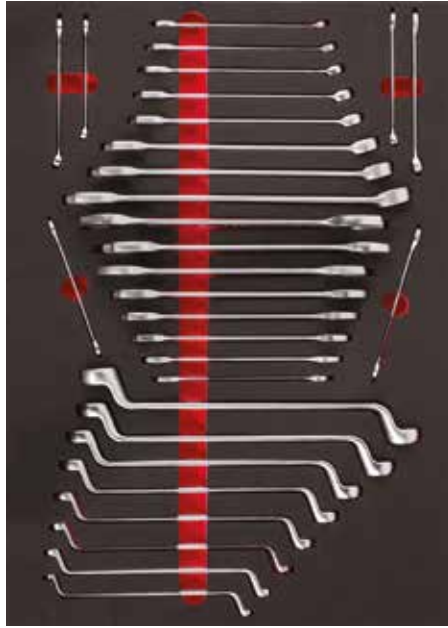

1. Pro Seri Çekmece/Drawer

Kod / Code 8241001030

KOD CODE	İÇERİK CONTENTS	□	FİYAT TL/Ad
0130	İki Ağız Anahtar Uzun Boy / D/E Open Jaw Wrench Long Pattern 6x7 - 8x9 - 10x11 - 12x13 14x15 - 16x17 - 18x19 - 20x22 21x23 - 24x26	10	
0330	Kombine Anahtar Uzun Boy / Combination Wrench Long Pattern 6 - 7 - 8 - 9 - 10 - 11 - 12 - 13 14 - 17 - 19 - 22	12	1626,45
0430	Yıldız Anahtar / D/E Ring Wrench 6x7 - 8x9 - 10x11 - 12x13 14x15 - 16x17 18x19 - 20x22	8	



2. Pro Seri Çekmece/Drawer

Kod / Code 8241002072

KOD CODE	İÇERİK CONTENTS	□	FİYAT TL/Ad
1107	1/4" Altı Köşe Lokma Takımı / 1/4" Socket Wrench Set 4 - 5 - 6 7 - 8 - 9 - 10 11 - 12 - 13 Altı Köşe Six Point 1/4" Cırcır kolu / 1/4" Ratchet Handle 1/4" Mafsals / 1/4" Universal Joint 1/4" T Kol / 1/4" Sliding T Handle	15	
1113	1/4" Ara Kol / 1/4" Extension Bar 50-100 mm 1/2" Lokma Takımı / 1/2" Socket Wrench Set 1/2" Cırcır Kolu 32 Diş / 1/2" Ratchet Handle 1/2" Mafsals / 1/2" Universal Joint 1/2" T Kol Adaptör / 1/2" Sliding T Handle Adapter 1/2" Ara Kol / 1/2" Extension Bar 125-250 mm	24	3195,35
1113	1/2" Lokmalı Allen Uçlar / 1/2" Hexagonal Bits Sockets H5-H6-H7-H8-H10-H12-H14	7	
1113	1/2" Lokmalı Star Uç / 1/2" Star Bits Socket T20-T25-T27-T30-T40-T45-T50-T55-T60	9	
0330	Kombine Anahtar Uzun Boy / Combination Wrench Long 16-18	2	
4900	Allen Takımı 6 Köşe / Hex Key Wrench Set 2-2.5-3-3.5-4-5-6-7-8-9-10-12	12	



3. Pro Seri Çekmece/Drawer

Kod / Code 8241003051

KOD CODE	İÇERİK CONTENTS	□	FİYAT TL/Ad
07415	Sıralı Tel Fırça 3 Sıralı / Hand Brush 3 Rows	1	
6350	Levye Oluklu / Tyre Lever 400 mm	1	
6220	Spiralli Mıknatıs / Flexible Magnet Holder 500 gr	1	
4110	Düz Topaç Tornavida / Screwdriver , Stubby, Flat 6.5x25	1	
4130	Yıldız Topaç Tornavida / Screwdriver , Stubby, Phillips 6x25	1	1505,30
4770	Lokma Uçlu Tornavida / Nutspinner 6-7-8-9-10-13	6	
4780	Manyetik Bits Tutucu Tornavida / Screwdriver, Magnetic Bit Holder 6.3x120	1	
4905	Yuvarlak Başlı Allen Takımı / Hexkey Wrench Ballpoint Set 2-2.5-3-4-5-6-8-10	8	
4800	Bits Set Takım (Plastik Kutulu) / Bits Set in Plastic Case	31	



4. Pro Seri Çekmece/Drawer

Kod / Code 8241004027

KOD CODE	İÇERİK CONTENTS	☐	FİYAT TL/Ad
0340	Cırcır Kombine Anahtar / Combination Wrench With Ratchet 10-13-17-19	4	
4909	T Tipi Torx Allen Anahtar / Torx Allen Key T type T9-T10-T15-T20-T25-T27-T30-T40	8	
1108	1/2" Altı Köşe Derin Lokma / 1/2" Deep Socket Wrench, six points 10-11-12-13-14-15-16-17-18-19	10	2640,85
1113	1/2" Altı Köşe Havalı Lokma / 1/2" Impact Socket Wrench 13-17-18-19-24	5	



5. Pro Seri Çekmece/Drawer

Kod / Code 8241005010

KOD CODE	İÇERİK CONTENTS	☐	FİYAT TL/Ad
3331	İç Eğri Segman Pense / Circlip Pliers, Internal, Bent 170 mm	1	
3321	İç Düz Segman Pense / Circlip Pliers, Internal, Flat 180 mm	1	
3311	Dış Eğri Segman Pense / Circlip Pliers, External, Bent 170 mm	1	
3301	Dış Düz Segman Pense / Circlip Pliers, External, Flat 180 mm	1	
3700	Yan Keski Opak İzole / Side Cutting Pliers, 160 mm	1	2181,35
3220	Düz Kargaburun Opak İzole / Nose Pliers, 200 mm	1	
3020	Kombine Pense Opak İzole / Combination Pliers, 180 mm	1	
2510	Ayarlı Pense / Special Grip 250 mm	1	
0600	Kurbağacık Anahtar / Adjustable Jaw Wrench 10"	1	
2400	Üniversal Fort Pense / Waterpump Pliers Universal 240 mm	1	



6. Pro Seri Çekmece/Drawer

Kod / Code 8241006018

KOD CODE	İÇERİK CONTENTS	☐	FİYAT TL/Ad
4300	Opak Seri Düz Uçlu Tornavida / Opak Screwdriver, Flat 4x100-5x125-6x150-8x175	4	
4320	Opak Seri Yıldız Uçlu Tornavida / Opak Screwdriver, Phillips 4.5x80-6x100	2	
5800	Tesviyeci Çekiç / Mechanist Hammer 300 gr	1	
5850	Plastik Çekiç / Plastic Hammer ø30	1	1221,90
5545	Konik Pim Zimba / Drift Punch 5 mm	1	
5550	Düz Pim Zimba / Split Pin Punch 5 mm	1	
5540	Nokta Zimba / Center Punch 5x120	1	
5500	Düz Keski / Flat Cold Chisel 150 mm	1	
4920	T Tipi Allen Anahtar / T Type Hex Key Wrench 3-4-5-6-7-8	6	



İZELTAS YOUTUBE

(*) İşaretili olan ürünler stoklarla sınırlıdır.

8242 GARAJ SERİSİ / GARAGE SERIES



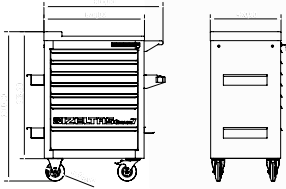



Garaj Serisi Takım Dolabı (5-6-7-8 Çekmeceli)
Garage Series Workshop Trolley (5-6-7-8 Drawers)



Ölçü/Size: 470x670x1010 mm

Sacdan imal edilmiş, Fırın boya
Made of sheet metal, Electrostatic paint



KOD/CODE	ÇEKMECE DRAWERS				KG	RENK COLORS	FİYAT TL/Ad
		400x548x68	400x548x143	400x548x218			
8242 32 1005	5	1X	4X	--	59		6708,85
8242 32 1006	6	4X	1X	1X	62		7896,75
8242 32 1007	7	5X	2X	--	65		9226,45
8242 32 1008	8	7X	1X	--	67		10128,60
8242 32 2005	5	1X	4X	--	59		6708,85
8242 32 2006	6	4X	1X	1X	62		7896,75
8242 32 2007	7	5X	2X	--	65		9226,45
8242 32 2008	8	7X	1X	--	67		10128,60
8242 32 3005	5	1X	4X	--	59		6708,85
8242 32 3006	6	4X	1X	1X	62		7896,75
8242 32 3007	7	5X	2X	--	65		9226,45
8242 32 3008	8	7X	1X	--	67		10128,60
8242 00 1142	7	5X	2X	--			18422,70
8242 00 8142	8	7X	1X	--			19324,85

✓ Ergonomik sap
● Ergonomic handle



✓ 8 Bölmeli, sağlam ABS tabla
● Durable ABS worktop with divisions



✓ Havluluk x1
Avadanlık x2 Askılık x1
● Paper Roll Holder x1
Bottle & Tins Holder x2 Hanger x1



✓ %100 açılabilir teleskobik raylar
● %100 extendable telescopic slides



✓ Merkezi kilit sistemi, mandal sistemi devrilme emniyet sistemi.
● Central locking, system handgrip lock system antitilt system



✓ 2 sabit, 2 hareketli frenli tekerlek Ø 125mm
● 2 swivel castors with brake 2 fixed castors Ø 125 mm



✓ Yüksek dayanımlı elektrostatik toz boya.
● High strength electrostatic powder coating



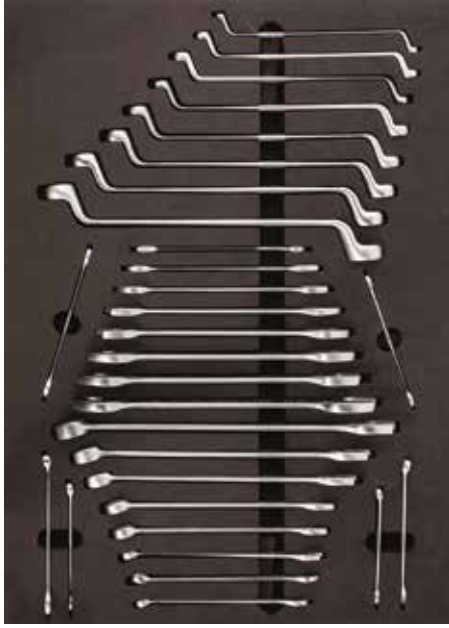

1. Garaj Seri Çekmece/Drawer

Kod / Code 8242001030

KOD CODE	İÇERİK CONTENTS	☐	FİYAT TL/Ad
0130	İki Ağız Anahtar Uzun Boy D/E Open Jaw Wrench Long Pattern 6x7 - 8x9 - 10x11 - 12x13 14x15 - 16x17 - 18x19 - 20x22 - 21x23 - 24x26	10	
0330	Kombine Anahtar Uzun Boy Combination Wrenches Long Pattern 6 - 7 - 8 - 9 - 10 - 11 - 12 - 13 - 14 - 17 - 19 - 22	12	1626,45
0430	Yıldız Anahtar Ring Wrench 6x7 - 8x9 - 10x11 - 12x13 - 14x15 - 16x17 18x19 - 20x22	8	

2. Garaj Seri Çekmece/Drawer

Kod / Code 8242002072



KOD CODE	İÇERİK CONTENTS	☐	FİYAT TL/Ad
1113	1/2" Lokmalı Allen Uçlar Hexagonal Bits Socket H5-H6-H7-H8-H10-H12-H14	7	
1113	1/2" Lokmalı Star Uç / 1/2 Star Bits Socket T20-T25-T27-T30-T40-T45-T50-T55-T60	9	
0330	Kombine Anahtar Uzun Boy Combination Pliers Long 16-18	2	
4900	Allen Takımı Altı Köşe / Hex Key Wrench Set 2-2.5-3-3.5-4-5-6-7-8-9-10-12	12	
1107	1/4" Altı Köşe Lokma Takımı Socket Wrench Set 4 - 5 - 6 7 - 8 - 9 - 10 11 - 12 - 13 Altı Köşe Six Points 1/4" Cırcır Kolu Ratchet Handle 1/4" Mafsal Universal Joint 1/4" T Kol / Sliding T Handle 1/4" Ara Kol / Extension Bar 50 -100 mm	15	3195,35
1113	1/2" Lokma Takımı Socket Wrench Set 10 - 11 - 12 13 - 14 - 15 16 - 17 - 18 19 - 21 - 22 23 - 24 - 26 27 - 28 - 30 32 Altı Köşe Six Points 1/2" Cırcır Kolu 32 Diş Ratchet Handle 1/2" Mafsal Universal Joint 1/2" T Kol Adaptör Sliding T Handle Adapter 1/2" Ara Kol Extension Bar 125-250 mm	24	

3. Garaj Seri Çekmece/Drawer

Kod / Code 8242003010

KOD CODE	İÇERİK CONTENTS	☐	FİYAT TL/Ad
3331	İç Eğri Segman Pense Circlip Pliers Internal (Bent) 170 mm	1	2181,35
3321	İç Düz Segman Pense Circlip Pliers Internal (Flat) 180 mm	1	
3311	Dış Eğri Segman Pense Circlip Pliers External (Bent) 170 mm	1	
3301	Dış Düz Segman Pense Circlip Pliers External (Flat) 180 mm	1	
3700	Yan Keski Opak Seri Side Cutting Pliers 160 mm	1	
3220	Düz Kargaburun Opak Seri Nose Pliers (Flat) 200 mm	1	
3020	Kombine Pense Opak Seri Combination Pliers 180 mm	1	
2510	Spesiyal Ayarlı Pense / Special Grip 250 mm	1	
0600	Kurbağacık Anahtar / Adjustable Wrench 10"	1	
2400	Üniversal Fort Pense / Waterpump Pliers Üniversal 240 mm	1	

4. Garaj Seri Çekmece/Drawer

Kod / Code 8242004018

KOD CODE	İÇERİK CONTENTS	☐	FİYAT TL/Ad
4300	Opak Seri Düz Uçlu Tornavida Screwdriver, Opak Flat 4x100-5x125-6x150-8x175	4	1221,90
4320	Opak Seri Yıldız Uçlu Tornavida Screwdriver, Opak Philips 4.5x80-6x100	2	
5800	Tesviyeci Çekiç Machinist's Hammer 300 gr	1	
5850	Plastik Çekiç Plastic Hammer ø30	1	
5545	Konik Pim Zimba Drift Punch 5 mm	1	
5550	Düz Pim Zimba Split Pin Punch 5 mm	1	
5540	Nokta Zimba Center Punch 5x120	1	
5500	Düz Keski Flat Cold Chisel 150 mm	1	
4920	T Tipi Allen Anahtar / Hex Key Wrench 3-4-5-6-7-8	6	

5. Garaj Seri Çekmece/Drawer

Kod / Code 8242005011

KOD CODE	İÇERİK CONTENTS	☐	FİYAT TL/Ad
07415	Sıralı Tel Fırça 3 Sıralı Hand Brush 3 Raws	1	971,20
6350	Levye Oluklu Tyre Lever, Straight 400 mm	1	
6220	Spiralli Miknatis Flexible Magnet Holder 500 gr	1	
4110	Düz Topaç Tornavida Screwdriver Stubby Flat 6.5x25	1	
4130	Yıldız Topaç Tornavida Screwdriver Stubby Phillips 6x25	1	
4770	Lokma Uçlu Tornavida Nut Spinner 6-7-8-9-10-13	6	



8235
PARTNER SERİSİ / PARTNER SERIES

Partner Mobil Takım Dolabı (5 Çekmeceli)
Partner Workshop Trolley (5 Drawers)



✓ Merkezi kilit sistemi ve mandal sistemi.
● Central lock system and handgrip lock system.



✓ Teleskobik rulmanlı kızaklar tüm çekmeceler %100 açılabilir.
● Telescopic slides which are %100 extendable.



✓ 8 Bölmeli, sağlam ABS tabla
● 8 Durable ABS worktop with divisions



✓ 2 sabit, 2 hareketli frenli tekerlek ø 100mm
● 2 swivel castors with brake
2 fixed castors ø 100 mm



✓ Yüksek dayanımlı elektrostatik toz boya.
● High strength electrostatic powder coating



Ölçü/Size: 470x670x975 mm

Sacdan imal edilmiş, Fırın boya
Made of sheet metal, Electrostatic paint

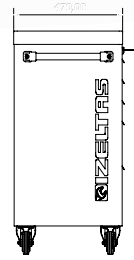
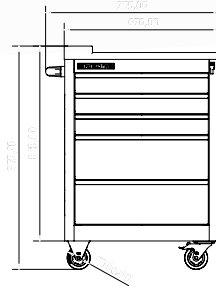





RAL 3020



RAL 5003



RAL 9005

KOD/CODE	ÇEKMECE DRAWERS	 35 kg	 35 kg	KG	RENK COLORS	FİYAT TL/Ad
8235 32 6005	5	3X	2X	56	 RAL 3020	6103,70
8235 32 5005	5	3X	2X	56	 RAL 5003	6103,70
8235 32 7005	5	3X	2X	56	 RAL 9005	6103,70
8235 00 6121 Dolu/Full 118 Parça/Pcs	5	3X	2X			12872,65

1. Partner Seri Çekmece/Drawer

Kod / Code 8235001072



KOD CODE	İÇERİK CONTENTS		FİYAT TL/Ad
1107	<p>1/4" Altı Köşe Lokma Takımı 1/4" Socket Wrench Set</p> <p>4 - 5 - 6 7 - 8 - 9 - 10 11 - 12 - 13 Altı Köşe Six Points</p>	15	
1113	<p>1/2" Cırcır Kolu 32 Diş Ratchet Handle</p> <p>10 - 11 - 12 13 - 14 - 15 16 - 17 - 18 19 - 21 - 22 23 - 24 - 26 27 - 28 - 30 - 32</p> <p>1/2" Mafsal Universal Joint</p> <p>1/2" T Kol Adaptör Sliding T Handle Adapter</p> <p>1/2" Ara Kol Extention Bar 125-250 mm</p>	24	3603,30
1507	<p>1/4" Derin Lokma Tornavida Adaptörü Spindle Handle</p>	1	
4900	<p>12 'li Allen Anahtar Takımı Hex Key Wrench Set 2-2.5-3-3.5-4-5-6-7-8-9-10-12 mm</p>	12	
4910	<p>8 'li Torx Allen Anahtar Takımı Torx Key Wrench T9-T10-T15-T20-T25-T27-T30-T40</p>	8	
1108	<p>1/2" Altı Köşe Derin Lokma Deep Socket Wrench 6 Point 10-13-16-17-18-19 mm</p>	6	
1113	<p>1/2" 16 mm Buji Lokma Anahtar Spark Plug Socket With Rubber</p>	1	
2400	<p>240 mm Üniversal Fort Pense Waterpump Pliers, Universal</p>	1	
2500	<p>250 mm Üniversal Ayarlı Pense Universal Grip</p>	1	



2. Partner Seri Çekmece/Drawer

Kod / Code 8235002031

KOD CODE	İÇERİK CONTENTS	□	FİYAT TL/Ad
0100	İki Ağız Anahtar Kısa Boy Double Ended Open Jaw Wrench Short Pattern 6x7 - 8x9 - 10x11 - 12x13 14x15 - 16x17 - 18x19 - 20x22 21x23 - 24x26 - 25x28 - 30x32	12	
0320	Kombine Anahtar Kısa Boy Combination Wrench Short Pattern 8 - 9 - 10 - 11 - 12 - 13 14 - 15 - 16 - 17 - 19 - 22	12	1620,60
0430	Yıldız Anahtar Ring Wrench 8x9 - 10x11 - 12x13 - 14x15 - 16x17 18x19 - 20x22	7	



3. Partner Seri Çekmece/Drawer

Kod / Code 8235003017

KOD CODE	İÇERİK CONTENTS	□	FİYAT TL/Ad
4300	Opak Seri Düz Uçlu Tornavida Screwdriver, Opak Flat 3x80-4x80-4x100-5x125-6x150	5	
4320	Opak Seri Yıldız Uçlu Tornavida Screwdriver, Opak Philips 4.5x80-6x100	2	
3700	Yan Keski Opak Seri Side Cutting Pliers 160 mm	1	
3020	Kombine Pense Opak Seri Combination Pliers 180 mm	1	1545,05
3220	Düz Kargaburun Opak Seri Nose Pliers Flat 200 mm	1	
4770	Lokma Uçlu Tornavida Nut Spinner 6-7-8-10-13	5	
5500	Düz Keski Flat Cold Chisel 150 mm	1	
5800	Tesviyeci Çekiçi Machinist's Hammer 500 gr	1	





**YENİ
NEW**

Ölçü/Size: 410x620x894 mm

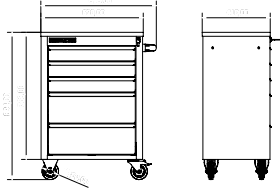

IZELTAS YOUTUBE

8243 32 1003 kodlu takım dolabında sayfa 23'deki sünger muhteviyatlarını kullanabilirsiniz

Sacdan imal edilmiş, Fırın boya
Made of sheet metal, Electrostatic paint



- ✓ Merkezi kilit
- Central locking



- ✓ %100 açılabilir teleskobik raylar.
- %100 extendable telescopic slides



- ✓ Yüksek dayanımlı elektrostatik toz boya.
- High strength electrostatic powder coating









- ✓ Elokсалlı alüminyum tutma çantası.
- Handle with anodised aluminum



- ✓ 2 sabit, 2 hareketli frenli tekerlek ø 100 mm
- 2 swivel castors with brake 2 fixed castors ø 100 mm



- ✓ 4 bölümlü sağlam ve dayanıklı ABS plastik üst malzeme tabla.
- Resistant and solid top cover with 4 divisions

KOD/CODE	ÇEKMECE DRAWERS			DEMONTÉ RAF DISASSEMBLED SHELF		RENK COLORS	FİYAT TL/Ad
		350x503x82	350x503x176				
8243 32 1003	3	3x	--	2	43		4452,70
8243 32 1005	5	3X	2X	--	43		4452,70
8243 32 1007	7	7X	--	--	43		5969,50
8243 32 2005	5	3X	2X	--	43		4452,70
8243 32 2007	7	7X	--	--	43		5969,50
8243 32 3005	5	3X	2X	--	43		4452,70
8243 32 3007	7	7X	--	--	43		5969,50
8243 00 1096 Dolu/Full 93 Parça/Pcs	5	3X	2X	--			9863,50
8243 00 7096 Dolu/Full 93 Parça/Pcs	7	7X	--	--			11380,30

1. Eko Seri Çekmece/Drawer

Kod / Code 8243001030

KOD/CODE	İÇERİK CONTENTS	☐	TL/Ad.
0100	İki Ağız Anahtar Kısa Boy D/E Open Jaw Wrench Short Pattern 6x7 - 8x9 - 10x11 - 12x13 14x15 - 16x17 - 18x19 - 20x22 - 21x23 - 24x26	10	
0320	Kombine Anahtar Kısa Boy Combination Wrench Short Pattern 8 - 9 - 10 - 11 - 12 - 13 - 14 - 15 - 16 - 17 - 19 - 22	12	1529,05
0430	Yıldız Anahtar Ring Wrench 6x7 - 8x9 - 10x11 - 12x13 - 14x15 - 16x17 18x19 - 20x22	8	

2. Eko Seri Çekmece/Drawer

Kod / Code 8243002052

KOD/CODE	İÇERİK CONTENTS	☐	TL/Ad.
1113	1113 1/2" 17'li Lokma Takımı Socket Wrench Set 1/2" mm 10 - 11 - 12 - 13 - 14 - 15 - 17 - 19 22 - 24 - 27 - 30 - 32 250 - 250 - 70	17	
1107	1/4" Altı Köşe Lokma Takımı Socket Wrench Set 1/4" mm 4 - 5 - 6 - 7 - 8 - 9 - 10 - 11 - 12 - 13 140 - 115 - 100 - 50 - 38	15	2282,10
4900	Allen Anahtar Takımı Hex Key Wrench Set 2 - 2.5 - 3 - 3.5 - 4 - 5 - 6 - 7 - 8 - 9 - 10 - 12	12	
4770	Lokma Uçlu Tornavidalar Nutspinners 6 - 7 - 8 - 10 - 13	5	

3. Eko Seri Çekmece/Drawer

Kod / Code 8243003013

KOD/CODE	İÇERİK CONTENTS	☐	TL/Ad.
4320	Opak Seri Yıldız Uçlu Tornavida Opak Screwdriver, Phillips 4,5x80-6x100	2	
4300	Opak Seri Düz Uçlu Tornavida Opak Screwdriver, Flat 4x100-5x125-6x150-8x175	4	
3700	Yan Keski Opak Seri Side Cutting Pliers 160 mm	1	
3020	Kombine Pense Opak Seri Combination Pliers 180 mm	1	
3220	Kargaburun Düz Uçlu Opak Seri Nose Pliers, Flat 160 mm	1	1599,65
5500	Düz Keski Krom Flat Cold Chisel 150 mm	1	
5800	Tesviyecici Çekici Machinist's Hammer 300 gr	1	
2510	Spesiyel Ayarlı Pense / Special Grip 250 mm	1	
2400	Üniversal Fort Pense / Waterpump Pliers Universal 240 mm	1	

Trend Serisi Takım Dolabı (5-7 Çekmeceli) Trend Series Workshop Trolley (5-7 Drawers)



✓ 4 bölmeli sağlam ve dayanıklı ABS plastik üst malzeme tabla.
● Resistant and solid top cover with 4 divisions



✓ %100 açılabilir teleskopik raylar.
● %100 extendable telescopic slides

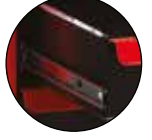

✓ Merkezi kilit
● Central locking



✓ 2 sabit, 2 hareketli frenli tekerlek ø 100 mm
● 2 swivel castors with brake
2 fixed castors ø 100 mm



✓ Yüksek dayanımlı elektrostatik toz boya
● High strength electrostatic powder coating



✓ Kendiliğinden açılmayı engelleyen plastik kilit
● Plastic lock preventing self opening





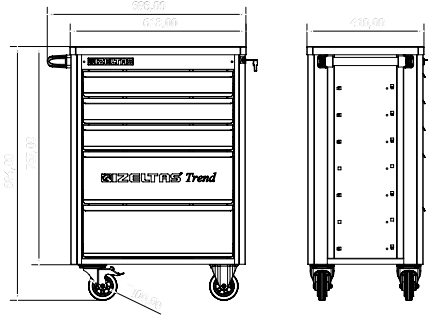

Ölçü/Size: 410x618x894 mm



İZELTAS YOUTUBE

Saddan imal edilmiş, Fırın boya
Made of sheet metal, Electrostatic paint

KOD/CODE	ÇEKMECE DRAWERS	 25 kg	 25 kg	 Kg	RENK COLORS	FİYAT TL/Ad
8244 32 1005	5	3X	2X	43		4470,60
8244 32 1007	7	7X	--	43		4654,85
8244 00 5096 Dolu/Full 93 Parça/Pcs	5	3X	2X			9881,40
8244 00 7096 Dolu/Full 93 Parça/Pcs	7	7X	--			10065,65



1. Trend Seri Çekmece/Drawer Kod / Code 8244001030

KOD/CODE	İÇERİK CONTENTS	☐	TL/Ad.
0100	İki Ağız Anahtar Kısa Boy D/E Open Jaw Wrench Short Pattern 6x7 - 8x9 - 10x11 - 12x13 14x15 - 16x17 - 18x19 - 20x22 - 21x23 - 24x26	10	
0320	Kombine Anahtar Kısa Boy Combination Wrench Short Pattern 8 - 9 - 10 - 11 - 12 - 13 - 14 - 15 - 16 - 17 - 19 - 22	12	1529,05
0430	Yıldız Anahtar Ring Wrench 6x7 - 8x9 - 10x11 - 12x13 - 14x15 - 16x17 18x19 - 20x22	8	



2. Trend Seri Çekmece/Drawer Kod / Code 8244002052

KOD/CODE	İÇERİK CONTENTS	☐	TL/Ad.
1113	1/2" 17'li Lokma Takımı Socket Wrench Set 1/2" mm 10 - 11 - 12 - 13 - 14 - 15 - 17 - 19 22 - 24 - 27 - 30 - 32 250 - 250 - 70 1/2" T Kol Adaptör Sliding T Handle Adapte	17	
1107	1/4" Altı Köşe Lokma Takımı Socket Wrench Set 1/4" mm 4 - 5 - 6 - 7 - 8 - 9 - 10 - 11 - 12 - 13 140 - 115 - 100 - 50 - 38	15	2282,10
4900	Allen Anahtar Takımı Hex Key Wrench Set 2 - 2.5 - 3 - 3.5 - 4 - 5 - 6 - 7 - 8 - 9 - 10 - 12	12	
4770	Lokma Uçlu Tornavidalar Nutspinners 6 - 7 - 8 - 10 - 13	5	



3. Trend Seri Çekmece/Drawer Kod / Code 8244003013

KOD/CODE	İÇERİK CONTENTS	☐	TL/Ad.
4320	Opak Seri Yıldız Uçlu Tornavida Opak Screwdriver, Phillips 4.5x80-6x100	2	
4300	Opak Seri Düz Uçlu Tornavida Opak Screwdriver, Flat 4x100-5x125-6x150-8x175	4	
3700	Yan Keski Opak Seri Side Cutting Pliers 160 mm	1	
3020	Kombine Pense Opak Seri Combination Pliers 180 mm	1	1599,65
3220	Kargaburun Düz Uçlu Opak Seri Nose Pliers, Flat 160 mm	1	
5500	Düz Keski Krom Flat Cold Chisel 150 mm	1	
5800	Tesviyecici Çekici Machinist Hammer 300 gr	1	
2510	Spesiyel Ayarlı Pense / Special Grip 250 mm	1	
2400	Üniversal Fort Pense / Waterpump Pliers Universal 240 mm	1	

Takım Dolabı Ahşap Üst Tablalı XXL (7 Çekmeceli) XXL Series Workshop Trolley (7 Drawers)

**YENİ
NEW**

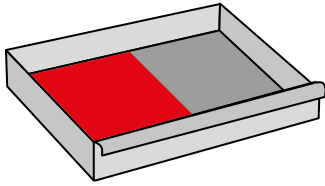

Aşağıda yazılı olan muhteşimli süngerlerden her bir çekmeceye İKİ (2) adet yerleştirilebilir.

- | | |
|--------------------------------|-----------------------|
| 1. Premium Seri Çekmece/Drawer | Kod / Code 8245001042 |
| 2. Premium Seri Çekmece/Drawer | Kod / Code 8245002094 |
| 3. Premium Seri Çekmece/Drawer | Kod / Code 8245003014 |
| 4. Premium Seri Çekmece/Drawer | Kod / Code 8245004043 |
| 5. Premium Seri Çekmece/Drawer | Kod / Code 8245005043 |
| 6. Premium Seri Çekmece/Drawer | Kod / Code 8245006009 |
| 1. Pro Seri Çekmece/Drawer | Kod / Code 8241001030 |
| 2. Pro Seri Çekmece/Drawer | Kod / Code 8241002072 |
| 3. Pro Seri Çekmece/Drawer | Kod / Code 8241003051 |
| 4. Pro Seri Çekmece/Drawer | Kod / Code 8241004027 |
| 5. Pro Seri Çekmece/Drawer | Kod / Code 8241005010 |
| 6. Pro Seri Çekmece/Drawer | Kod / Code 8241006018 |
| 1. Garaj Seri Çekmece/Drawer | Kod / Code 8242001030 |
| 2. Garaj Seri Çekmece/Drawer | Kod / Code 8242002072 |
| 3. Garaj Seri Çekmece/Drawer | Kod / Code 8242003010 |
| 4. Garaj Seri Çekmece/Drawer | Kod / Code 8242004018 |
| 5. Garaj Seri Çekmece/Drawer | Kod / Code 8242005011 |
| 1. Partner Seri Çekmece/Drawer | Kod / Code 8235001072 |
| 2. Partner Seri Çekmece/Drawer | Kod / Code 8235002031 |
| 3. Partner Seri Çekmece/Drawer | Kod / Code 8235003017 |

Ölçü/Size: 470x1224x964 mm

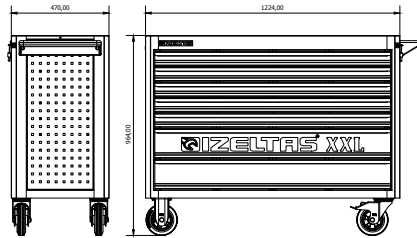

- ✓ 18mm masif üst tabla
- 18 mm solid wood top

- ✓ %100 açılabilir teleskobik raylar.
- %100 extendable telescopic slides

- ✓ Merkezi kilit
- ✓ Mandal sistemi
- ✓ Devrilme emniyet sistemi
- Central lock
- Handgrip Lock system
- Anti tilt system



- ✓ Ergonomik sap
- Ergonomic handle

- ✓ 2 sabit, 2 hareketli frenli tekerlek ø 150mm
- 2 swivel castors with brake
- 2 fixed castors ø 150mm

- ✓ Yüksek dayanımlı elektrostatik toz boya.
- High strength electrostatic powder coating.

- ✓ 10 adet seperetör A4 avadamlık
- 10 separators A4 kit

Sacdan imal edilmiş, Fırın boya
Made of sheet metal, Electrostatic paint

KOD/CODE	ÇEKMECE DRAWERS				RENK COLORS	FİYAT TL/Ad
1098x400x60	1098x400x135	5X	2X			

8246 32 1007

7

5X

2X

RAL 7016
RAL 3020

11193,00

8247

Takım Dolabı Ahşap Üst Tablalı Workbench (7 Çekmeceli) Workbench Series Workshop Trolley (7 Drawers)

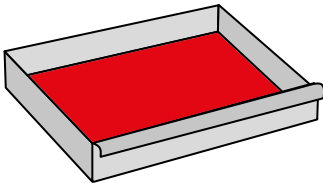
**YENİ
NEW**

Aşağıda yazılı olan muhteviyatlı süngerlerden her bir çekmeceye BİR (1) adet yerleştirilebilir.

- | | |
|--------------------------------|-----------------------|
| 1. Premium Seri Çekmece/Drawer | Kod / Code 8245001042 |
| 2. Premium Seri Çekmece/Drawer | Kod / Code 8245002094 |
| 3. Premium Seri Çekmece/Drawer | Kod / Code 8245003014 |
| 4. Premium Seri Çekmece/Drawer | Kod / Code 8245004043 |
| 5. Premium Seri Çekmece/Drawer | Kod / Code 8245005043 |
| 6. Premium Seri Çekmece/Drawer | Kod / Code 8245006009 |
| 1. Pro Seri Çekmece/Drawer | Kod / Code 8241001030 |
| 2. Pro Seri Çekmece/Drawer | Kod / Code 8241002072 |
| 3. Pro Seri Çekmece/Drawer | Kod / Code 8241003051 |
| 4. Pro Seri Çekmece/Drawer | Kod / Code 8241004027 |
| 5. Pro Seri Çekmece/Drawer | Kod / Code 8241005010 |
| 6. Pro Seri Çekmece/Drawer | Kod / Code 8241006018 |
| 1. Garaj Seri Çekmece/Drawer | Kod / Code 8242001030 |
| 2. Garaj Seri Çekmece/Drawer | Kod / Code 8242002072 |
| 3. Garaj Seri Çekmece/Drawer | Kod / Code 8242003010 |
| 4. Garaj Seri Çekmece/Drawer | Kod / Code 8242004018 |
| 5. Garaj Seri Çekmece/Drawer | Kod / Code 8242005011 |
| 1. Partner Seri Çekmece/Drawer | Kod / Code 8235001072 |
| 2. Partner Seri Çekmece/Drawer | Kod / Code 8235002031 |
| 3. Partner Seri Çekmece/Drawer | Kod / Code 8235003017 |

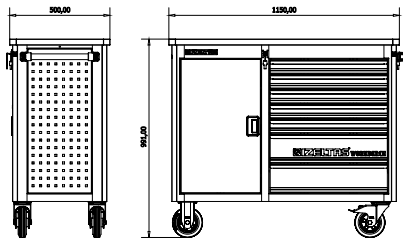
Ölçü/Size: 500x1150x991 mm

- ✓ 30 mm masif ahşap üst tabla
- 30 mm solid wood top

- ✓ %100 ağırlabilir teleskobik raylar.
- %100 extendable telescopic slides

- ✓ Merkezi kilit
- ✓ Mandal sistemi
- ✓ Devrilme emniyet sistemi
- Central lock
- Handgrip Lock system
- Anti tilt system

- ✓ Standard tutma sapı
- Standard handle

- ✓ 2 sabit, 2 hareketli frenli tekerlek ø 150mm
- 2 swivel castors with brake
- 2 fixed castors ø 150mm

- ✓ Yüksek dayanımlı elektrostatik toz boya.
- High strength electrostatic powder coating.

- ✓ 4 kısa, 2 uzun seperetör
- 4 Short, 2 long separators

Saddan imal edilmiş, Fırın boya
Made of sheet metal, Electrostatic paint

KOD/CODE	ÇEKMECE DRAWERS	35 kg	35 kg	Kg	RENK COLORS	FİYAT TL/Ad
8247 32 1007	7	400x548x60	400x548x134			

8247 32 1007

7

5X

2X

 RAL 7016
RAL 3020

10504,00

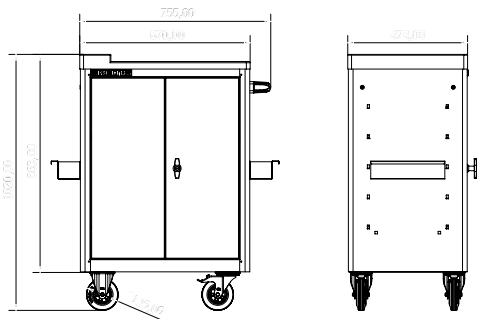
Vagon Serisi Takım Dolabı
Wagon Series Workshop Trolley**Ölçü/Size: 474x670x1020 mm**

- ✓ 8 Bölmeli, sağlam ABS tabla
- Durable ABS worktop with divisions



- ✓ Kilit T kol
- Locked T-handle



- ✓ 2 Sabit, 2 hareketli frenli tekerlek ø 125mm
- 2 swivel castors with brake 2 fixed castors ø 125 mm



- ✓ Yüksek dayanımlı elektrostatik toz boya.
- High strength electrostatic powder coating



- ✓ 2X ayarlanabilir raf (10 adet seperatör ile)
- 2x adaptable shelves with separator 10 pcs



- ✓ Standard tutma sapı
- Standard handle



- ✓ 2X avadanlık
- 2X tin holder

**Sacdan imal edilmiş, Fırın boya**
Made of sheet metal, Electrostatic paint

KOD/CODE	Ölçü / SIZE (mm)	Kg	RENK COLORS	FİYAT TL/AD
----------	------------------	----	-------------	-------------

8210 32 6001

474x670x1020

45

RAL 7016
RAL 3020

4709,20

8160
Takım Dolabı
Tool Cabinet

- ✓ Kollu kilit
- Locked T-handle



- ✓ %100 açılabilir teleskobik raylar.
- %100 extendable telescopic slides



- ✓ 4 hareketli frenli tekerlek ø 50mm
- 4 swivel castors with brake ø 50 mm



- ✓ Yüksek dayanımlı elektrostatik toz boya.
- High strength electrostatic powder coating



- ✓ Avadanlık x2
- Bottle and tins holder x2



- ✓ Askılık x4
- Hanger x4



- ✓ Özel askılık x4
- Special hanger x4



- ✓ Anahtar askısı x1
- Hanger for wrenches x1

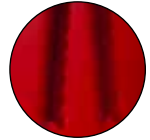

- ✓ Özel avadanlık x1
- Special tin holder x1

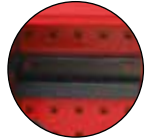
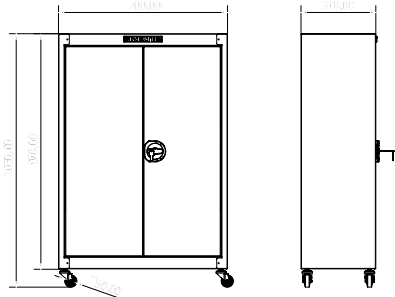

- ✓ Matkap ucu tutucu x1
- Drill bits holder x1

Ölçü/Size: 310x700x1050 mm

Sacdan imal edilmiş, Fırın boya
Made of sheet metal, Electrostatic paint

KOD/CODE	20 Kg	Ölçü / SIZE (mm)	Kg	COLORS	FİYAT TL/Ad.
228x567x58					

8160 32 6001

3x

310x700x1050

35

 RAL 7016
RAL 3020

4247,10

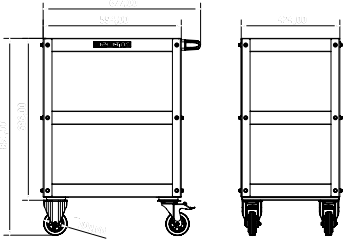
Demonte Mini Servis Arabası
Disassembled Mini Service Trolley

- **3X Kauçuk Kaydırmaz Mat**
3X Rubber Anti Slipping Mats
- **2X Sabit, 2X Hareketli Frenli Tekerlek (ø 100 mm)**
2X Fixed, 2X Swivel Castors with Brake (ø 100 mm)
- **Sağlam sac metal yapı, Her raf 50 Kg taşır.**
Robust sheet-steel construction, Loading capacity per shelf 50 Kg



Çelik konstrüksiyon
Steel construction

KOD/CODE	 420x590x57	Ölçü / SIZE (mm)	 Kg	COLORS	FIYAT TL/Ad.
----------	---	------------------	---	--------	-----------------

8550 34 8001

3X

424x594x851

18

RAL 9005
RAL 3020

2023,75

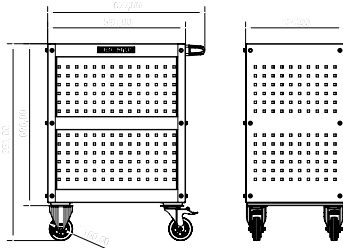
Demonte Mini Servis Arabası (kapalı)
Disassembled Mini Service Trolley (closed)

- **3X Kauçuk Kaydırmaz Mat**
3X Rubber Anti Slipping Mats
- **2X Sabit, 2X Hareketli Frenli Tekerlek (ø 100 mm)**
2X Fixed, 2X Swivel Castors with Brake (ø 100 mm)
- **Sağlam sac metal yapı, Her raf 50 Kg taşır.**
Robust sheet-steel construction, Loading capacity per shelf 50 Kg
- **Arabanın yanları ve arkasında kare askı delikleri**
Square-shaped perforation on the side panels and back panel offers individual fastening



Çelik konstrüksiyon
Steel construction

KOD/CODE	 420x590x57	Ölçü / SIZE (mm)	 Kg	COLORS	FIYAT TL/Ad.
----------	---	------------------	---	--------	-----------------

8550 34 8002

3X

424x594x851

23

RAL 9005
RAL 3020

2333,80

8545

Taşıma Arabası Platform Wagon

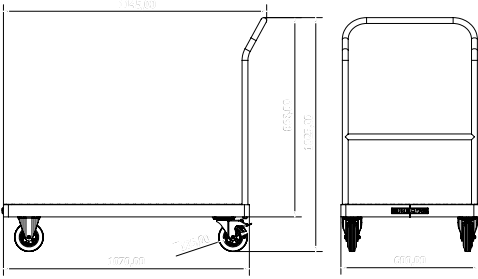

- **12mm PVC kaplı kontrplak Tabla**
12mm PVC coated plywood
- **2X Sabit, 2X Hareketli Frenli Tekerlek (ø 125mm)**
2X Fixed, 2X Swivel Castors with Brake (ø 125mm)
- **Sağlam sac metal yapı, Her raf 310 Kg taşır.**
Robust sheet-steel construction, Loading capacity per shelf 310 Kg

Çelik konstrüksiyon
Steel construction

KOD/CODE	Ölçü / SIZE (mm)	Kg	COLORS	FIYAT TL/Ad.
----------	------------------	----	--------	--------------

8545 34 1005

600x1145x1025

38

RAL 9005

6131,30

8550

Servis Arabası (Büyük Boy) Service Trolley (Large Size)

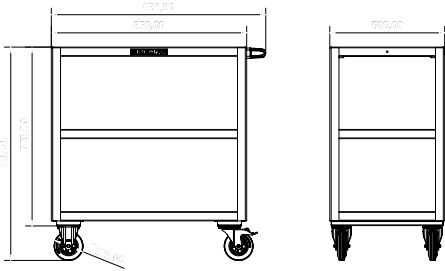

- **3X Kauçuk Kaydırmaz Mat**
3X Rubber Anti Slipping Mats
- **2X Sabit, 2X Hareketli Frenli Tekerlek (ø 125 mm)**
2X Fixed, 2X Swivel Castors with Brake (ø 125 mm)
- **Sağlam sac metal yapı, Her raf 75 Kg taşır.**
Robust sheet-steel construction, Loading capacity per shelf 75 Kg

Çelik konstrüksiyon
Steel construction

KOD/CODE	Ölçü / SIZE (mm)	Kg	COLORS	FIYAT TL/Ad.
----------	------------------	----	--------	--------------



494x844x40

500x850x935

37

RAL 3020

3360,85

8550 34 6001

3X

500x850x935

37

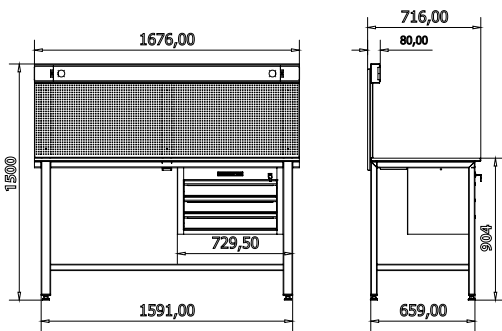
Servis Masası (Panolu)
Work Bench (With Panel)

- **Merkezi kilit sistemi, mandal sistemi**
Central locking system, handgrip lock system
- **Kaynaklı sağlam tasarım**
Robust welded design
- **%100 Açılabilir teleskobik raylar**
100% extendable telescopic slides
- **Yüksek dayanımlı elektrostatik toz boya.**
High strength electrostatic powder paint
- **Delikli panel (220 V prizler ile).**
Perforated panel with electrical plugs 220 V

Çelik Konstrüksiyon ve zor koşullarda çalışmaya elverişli
Özel Plywood ahşap tezgah
Strong and durable steel construction and Plywood bench

KOD/CODE		Ölçü / SIZE (mm)	 Kg	COLORS	FİYAT TL/Ad.
----------	---	------------------	--	--------	--------------

8500 34 6001

3X

720x1680x1495

102

RAL 7016
RAL 3020

8408,40

8501

Servis Masası (Panosuz)
 Work Bench (Without Panel)

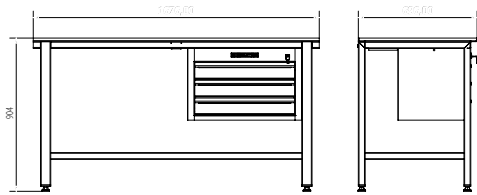

- **Merkezi kilit sistemi, mandal sistemi**
Central locking system, handgrip lock system
- **Kaynaklı sağlam tasarım**
Robust welded design
- **%100 Açılabilir teleskobik raylar**
100% extendable telescopic slides
- **Yüksek dayanımlı elektrostatik toz boya.**
High strength electrostatic powder paint

Çelik konstrüksiyon ve zor koşullarda çalışmaya elverişli
 Özel Plywood ahşap tezgah
 Strong and durable steel construction and Plywood bench

KOD/CODE		Ölçü / SIZE (mm)	 Kg	COLORS	FİYAT TL/Ad.
	348x548x90				

8501 34 6001

3X

700x1680x900

84

 RAL 7016
 RAL 3020

6366,40

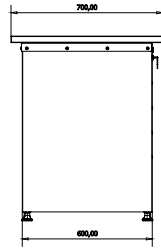
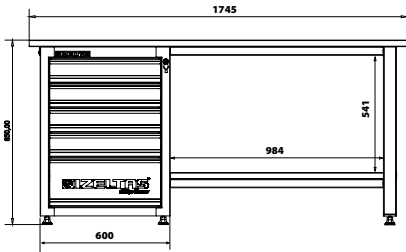
Demonte Atölye Masası
*Disassembled Workbench***YENİ
NEW**

- ✓ %100 açılabilir teleskobik raylar.
- %100 extendable telescopic slides





- ✓ Merkezi kilit
- ✓ Mandal sistemi
- Central lock
- Handgrip Lock system



- **Demonte sağlam tasarım**
Robust disassembled design
- **30mm masif ahşap**
30 mm solid wood
- **Ayarlanabilir ayaklar**
Height adjustable feet

**Çelik konstrüksiyon**
Steel construction

KOD/CODE	ÇEKMECE DRAWERS				RENK COLORS	FİYAT TL/Ad
----------	--------------------	---	---	---	----------------	----------------

8502 34 6002

5

4X

1X

RAL 7016
RAL 3020

21496,20

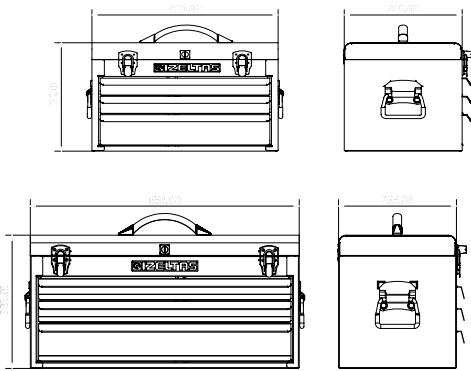

Çekmeceli Alet Sandığı
Tool Chest With Drawers

Sacdan imal edilmiş, Fırın boya
Made from metal sheet, Electrostatic paint

KOD/CODE	Ölçü / SIZE (mm)	ÇEKMECE DRAWERS	Alet Sandığı İçeriği		Kg	FİYAT TL/Ad
			2x	1x		
8320 33 1001	285x450x322	3X	238x370x47	238x370x87	16	2792,55
8320 33 1003	285x650x322	3X	238x570x47	238x570x87	20	3055,65

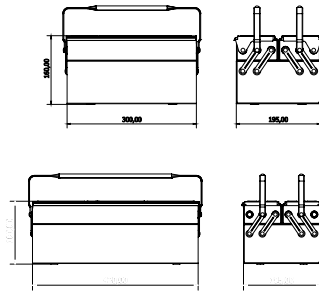
8410
Takım Çantası (3 Gözlü)
Tool Box (3 Trays)

Sacdan imal edilmiş, Fırın boya
 Made from metal sheet, Electrostatic paint

KOD CODE	Ölçü / SIZE (mm)	g	Ad	FİYAT TL/Ad
8410 33 6103	195x300x160	2400	1	356,00
8410 33 6203	195x420x160	3000	1	425,55

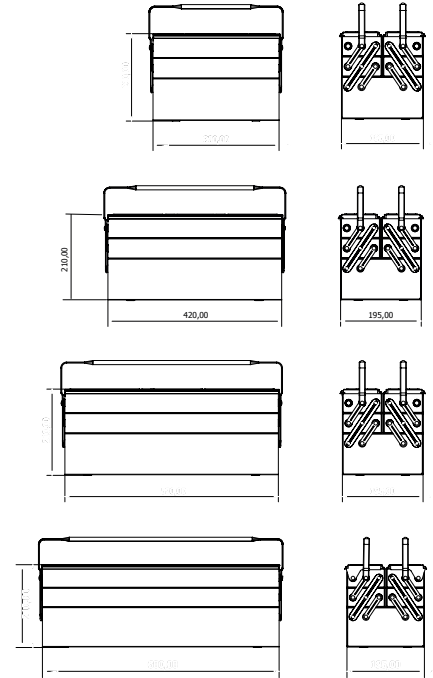
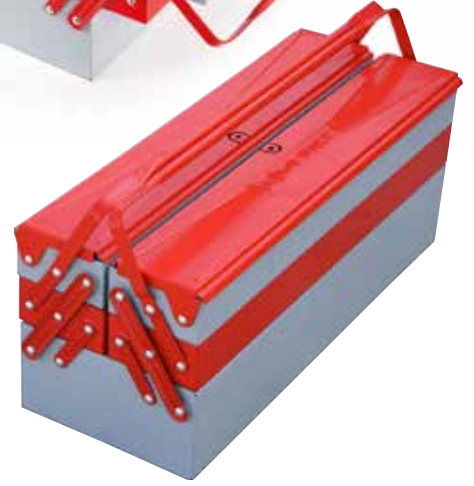
8420
Takım Çantası (5 Gözlü)
Tool Box (5 Trays)

Sacdan imal edilmiş, Fırın boya
 Made from metal sheet, Electrostatic paint

KOD CODE	Ölçü / SIZE (mm)	g	Ad	FİYAT TL/Ad
8420 33 6105	195x300x210	3200	1	626,90
8420 33 6205	195x420x210	4200	1	649,10
8420 33 6305	195x520x210	5000	1	754,30
8420 33 6405	195x600x210	5600	1	794,85

(*) İşaretili olan ürünler stoklarla sınırlıdır.
 Limited with stocks.

Takım Çantası (5 Gözlü)
Tool Box (5 Trays)**8420 00 5063****Mekanikçi Takım Çantası (62 Parça, 5 Gözlü)**
Tool Box for Mechanician (62 Pcs, 5 Trays)**8420 00 5046****Elektrikçi Takım Çantası (45 Parça, 5 Gözlü)**
Tool Box for Electrician (45 Pcs, 5 Trays)**8420 00 5028****Tesisatçı Takım Çantası (28 Parça, 5 Gözlü)**
Tool Box for Plumbers (28 Pcs, 5 Trays)

8420 00 5063
Mekanikçi Takım Çantası (5 Gözlü)
Tool Box for Mechanician (5 Trays)

KOD CODE	ÖLÇÜ SIZE mm	TL/Ad.
8420 00 5063	195x420x210 DOLU / FULL	62 3801,60

KOD CODE	İÇERİK CONTENTS	
05881 50 015	5 m Krom Şerit Metre Chrom Case Steel, Measuring tapes	1
4785 19 6330	6.3x30 Kısa Bits Tutucu Tornavida Screwdriver, Magnetic Bit Holder (Short)	1
4800 00 8110	10 'Lu Bits Takım Bits Set 10 (Pcs) 25 mm	10
4320	Opak Seri Yıldız Uçlu Tornavida Screwdriver, Opak, Flat 4.5x80-6x100	2
4300	Opak Seri Düz Uçlu Tornavida Screwdriver, Opak, Philips 3x80-4x100-5x125-6x150	4
4550 17 0135	135mm Kontrol Kalem Voltage Tester	1
2400 11 0240	240mm Üniversal Fort Pense Water Pump Pliers Universal	1
1113	1/2" Lokma Anahtar Socket Wrench 10-11-12-13-14-15-17-19-22-24-27-30-32	13
1513 06 4250	1/2" Uzun Ara Kol Extension Bar Long 250 mm	1
1513 06 4070	1/2" Mafsals Universal Joint 70 mm	1
1513 06 0032	1/2" Cırcır Kol 32 Dişli Ratchet Handle 250 mm	1
4900 00 3112	12 'Li Allen Anahtar Takım 6 Köşe Hex Key Wrench Set 2-2.5-3-3.5-4-5-6-7-8-9-10-12	12
0320	Kısa Kombine Anahtar Combination Wrench Short Pattern 8-9-10-11-12-13-14-17-19-22	10
3700 16 2160	160mm Yan Keski Opak Seri Side Cutting Nippers, Opak insulated	1
3020 12 2180	180mm Kombine Pense Opak Seri Combination Pliers, Opak Insulated	1
3220 13 2160	160mm Düz Kargaburun Opak Seri Nose Pliers, Flat, Opak Insulated	1

8420 00 5046
Elektrikçi Takım Çantası (5 Gözlü)
Tool Box for Electrician (5 Trays)

KOD CODE	ÖLÇÜ SIZE mm	TL/Ad.
8420 00 5046	195x420x210 DOLU / FULL	45 4320,95

KOD CODE	İÇERİK CONTENTS	
05881 50 005	5m Plastik Şerit Metre Plastic Measuring Tape	1
4783 19 6120	1000V İzoleli Manyetik Bits Tutucu Tornavida Screwdriver, Magnetic Bit Holder Insulated 6.3x120	1
4800 00 8106	6 'Lı Bits Takım Bits Set (6 Pcs)	6
0600 01 1010	10" Kurbağacık Anahtar Adjustable Jaw Wrench	1
4140-4145	1000V İzoleli Elektrikçi Düz, Yıldız Tornavida Insulated Electrician type Flat Screwdriver, Phillips 1000V 4x100-5.5x125 - 4.5x80-6x100	4
4550 17 0135	135mm Kontrol Kalem Voltage Tester	1
4550 17 0190	190mm Kontrol Kalem Voltage Tester	1
4773	1000V Süngüsü İzoleli Lokma Uçlu Tornavida Nut Spinner, Electrician Blade Insulated 1000V 6-7-8-10-13	5
0340	Cırcır Kombine Anahtar Combination Wrench With Ratchet 8-10-12-13-17-19	6
4900 00 3110	10 'Lu Allen Anahtar Takımı (mm) Hex Key Wrench Set 10 pcs 2-2.5-3-4-5-6-7-8-9-10	10
4500-4520	Klemens Tornavida Screwdriver, Electronic 3x80-3x100-3x125-3x60-4x80	5
3700 16 6160	1000V İzoleli Elektrikçi 160mm Yan Keski Insulated Electrician Type Side Cutter 1000V	1
3020 12 6180	1000V İzoleli Elektrikçi 180mm Kombine Pense Insulated Electrician Type Combination Plier 1000V	1
3220 13 6160	1000V İzoleli Elektrikçi 160mm Kargaburun Düz Insulated Electrician Type Nose Plier 1000V	1

8420 00 5028
Tesisatçı Takım Çantası (5 Gözlü)
Tool Box for Plumbers (5 Trays)

KOD CODE	ÖLÇÜ SIZE mm	TL/Ad.
8420 00 5028	195x420x210 DOLU / FULL	28 3737,25

KOD CODE	İÇERİK CONTENTS	
0600 01 1010	10" Kurbağacık Anahtar 10" Adjustable Jaw Wrench, PVC Insulated	1
0600 01 1012	12" Kurbağacık Anahtar 12" Adjustable Jaw Wrench, PVC Insulated	1
2400 11 0240	240 Üniversal Fort Pense 240 Waterpump Pliers, Universal	1
2100 10 0012	12" Stilson Boru Anahtarı 12" Pipe Wrench, Stilson	1
4901 22 1270	1/2" Sae Allen Anahtar 1/2" Hex Key Wrench SAE	1
4300 17 6150	Opak Seri Düz Uçlu Tornavida Screwdriver, Opak, Slotted 6x150	1
4320 18 6100	Opak Seri Yıldız Uçlu Tornavida Screwdriver, Opak, Phillips 6x100	1
5800 25 0500	500gr Çekiç Machinist Hammer	1
5500 23 0200	200mm Düz Keski Flat Cold Chisel	1
3830 15 0250	250mm Betoncu Kerpeten Tower Pincers	1
4900 00 3112	12 'Li Allen Anahtar Takımı (mm) Hex Key Wrench Set 12 pcs 2-2.5-3-3.5-4-5-6-7-8-9-10-12	12
0588 15 0015	5m Krom Şerit Metre Chrom Case Steel Measuring Tape	1
2201 10 0010	1" Maşalı Boru Anahtarı 1" Pipe Wrench	1
3700 16 2160	160mm Yan Keski Opak Seri Side Cutting Nippers, Opak insulated	1
3020 12 2180	180mm Kombine Pense Opak Seri Combination Pliers, Opak Insulated	1
3220 13 2160	160mm Düz Kargaburun Opak Seri Nose Pliers, Flat, Opak Insulated	1

8440

Plastik Takım Çantaları
Plastic Tool Boxes



KOD CODE	inch	ÖLÇÜ SIZE mm	g	TL/ Ad.
8440 33 1016	16"	413x212x186	1207	4 187,05
8440 33 1019	19"	480x267x242	1922	4 261,85
8440 33 1022	22"	564x310x310	2870	4 429,00

8445

Tekerlekli Plastik Takım Çantası
Plastic Mobile Tool Chest



KOD CODE	inch	ÖLÇÜ SIZE mm	g	TL/ Ad.
8445 33 1028	28"	380x595x420	5900	1 1034,05

8705 00 6113

Hobby Set Oto Tipi (13 Parça)
Hobby Set Auto Type (13 pcs)



KOD CODE	İÇERİK CONTENTS	TL/Ad.
0100	İki Ağız Anahtar (Kısa Boy) Duble Ended Open Jaw Wrench Short Pattern 8x9-10x11-12x13-14x15-16x17-18x19	6
1841	21 mm Kovan Anahtar Bir Ağız ve Mil Single Ended Tubular Socket Wench	1
2400	240 mm Ünlversal Fort Pense Waterpump Pliers Universal	1
3020	160 mm Kombine Pense Opak Seri Combination Pliers	1
4240	Değişken Uçlu Tornavida Takımı Screwdriver Set Reversible 4.5x80 - 6x80	2
5800	200 gr Tesviyecı Çekiç / Machinist Hammer	1
6350	300 mm Levye Oluklu / Tyre Lever Straight	1

8790 00 8106

Bakım Onarım Seti (5 Parça)
Maintenance Set (5 Pcs)



KOD CODE	İÇERİK CONTENTS	TL/Ad.
3020 12 3160	160 mm Kombine Pense Kraft Seri Combination Pliers	1
3220 13 3160	160 mm Kargaburun Düz Uçlu Kraft Seri Nose Pliers Flat	1
3700 16 3140	140 mm Yan Keski Kraft Seri Side Cutting Pliers	1
4100 17 5100	5x100 Kraft Seri Düz Uçlu Tornavida Screwdriver Kraft, Flat	1
4120 18 4580	4.5x80 Kraft Seri Yıldız Uçlu Tornavida Screwdriver Kraft, Phillips	1

★8793 00 1014
Bakım Seti (14 Parça)
Maintenance Set (14 Pcs)

KOD CODE	İÇERİK CONTENTS	☐	TL/Ad.
0130	İki Ağız Anahtar (Uzun Boy) Duble Ended Open Jaw Wrench Long Pattern 6x7-8x9-10x11-12x13-14x15-16x17-18x19-20x22	8	
★3220	160 mm Kargaburun Düz Uçlu Ergonomik Seri Nose Pliers Flat	1	
★3700	140 mm Yan Keski Ergonomik Seri Side Cutting Pliers	1	936,10
★4350	Ergonomik Seri Düz Uçlu Tornavida 4x100-6x100 Screwdriver Ergonomic, Flat	2	
★4370	Ergonomik Seri Yıldız Uçlu Tornavida 4.5x80-6x100 Screwdriver Ergonomic, Phillips	2	

8786 00 1003
Doğada Set (3 Parça)
Outdoor Set (3 Pcs)

 İZELTAS USTA İŞİ
 SOHBETLER

KOD CODE	İÇERİK CONTENTS	☐	TL/Ad.
6710 27 0230	Bağ Makası Lüks / Pruning Shears	1	
6735 27 0300	Dal Budama Testeresi / Pruning Saw	1	1027,10
6410 25 0800	Nacak / Hatchet	1	

8779 00 8741
Motosiklet Bakım Seti
(42 Parça)
Biker Set (42 Pcs)

KOD CODE	İÇERİK CONTENTS	☐	TL/Ad.
0100 01 0809	İki Ağız Anahtar Kısa Boy 08x09 Double Ended Open Jaw Wrench Short Pattern mm	1	
0100 01 1011	İki Ağız Anahtar Kısa Boy 10x11 Double Ended Open Jaw Wrench Short Pattern mm	1	
0100 01 1213	İki Ağız Anahtar Kısa Boy 12x13 Double Ended Open Jaw Wrench Short Pattern mm	1	
0100 01 1415	İki Ağız Anahtar Kısa Boy 14x15 Double Ended Open Jaw Wrench Short Pattern mm	1	
0100 01 1617	İki Ağız Anahtar Kısa Boy 16x17 Double Ended Open Jaw Wrench Short Pattern mm	1	
0600 01 1008	Kurbağacık Anahtar 8" Adjustable Wrench 8"	1	
1107 06 0006	1/4" Altı Köşe 6 mm Lokma Anahtar Socket Wrench 6 Point (6mm)	1	
1107 06 0008	1/4" Altı Köşe 8 mm Lokma Anahtar Socket Wrench 6 Point (8mm)	1	
1107 06 0010	1/4" Altı Köşe 10 mm Lokma Anahtar Socket Wrench 6 Point (10mm)	1	
1107 06 0011	1/4" Altı Köşe 11 mm Lokma Anahtar Socket Wrench 6 Point (11mm)	1	1281,25
1107 06 0012	1/4" Altı Köşe 12 mm Lokma Anahtar Socket Wrench 6 Point (12mm)	1	
1107 06 0013	1/4" Altı Köşe 13 mm Lokma Anahtar Socket Wrench 6 Point (13mm)	1	
1107 06 5010	1/4" Bits Tutucu Lokma Miknatıslı Bit Holder Socket	1	
4240 00 7102	Değişken Uçlu Tornavida Takımı Screwdriver Set Reversible	2	
4800 00 8106	6'lı Bits Set (25 mm) Bit Set 6 Pcs	6	
4900 00 3110	Allen Anahtar Takımı 10 Parça Hex Set Wrench Set (10 Pcs)	10	
4910 00 7108	Torx Allen Anahtar Takımı 8 Parça Torx Key Wrench Set (8 Pcs)	8	
1507 06 0050	1/4" Ara Kol 50 mm Extension Bar 50 mm	1	
1507 06 2140	1/4" Cırcır Kolu 140 mm Ratchet Wrench 140 mm	1	
1507 06 4080	1/4" Derin Tornavida Adaptörü Spindle Handle	1	

**ŞABLON
BİLLET**



**FİNAL ÜRÜN
FINAL PRODUCT**



ANAHTARLAR

WRENCHES

İki Ağız Anahtarlar
Open Jaw Wrenches

Kombine Anahtarlar
Combination Wrenches

Yıldız Anahtarlar
Ring Wrenches

Çakma Anahtarlar
Slugging Wrenches

Kurbağacık Anahtarlar
Adjustable Wrenches



İKİ AĞIZ ANAHTAR / DOUBLE ENDED OPEN JAW WRENCH

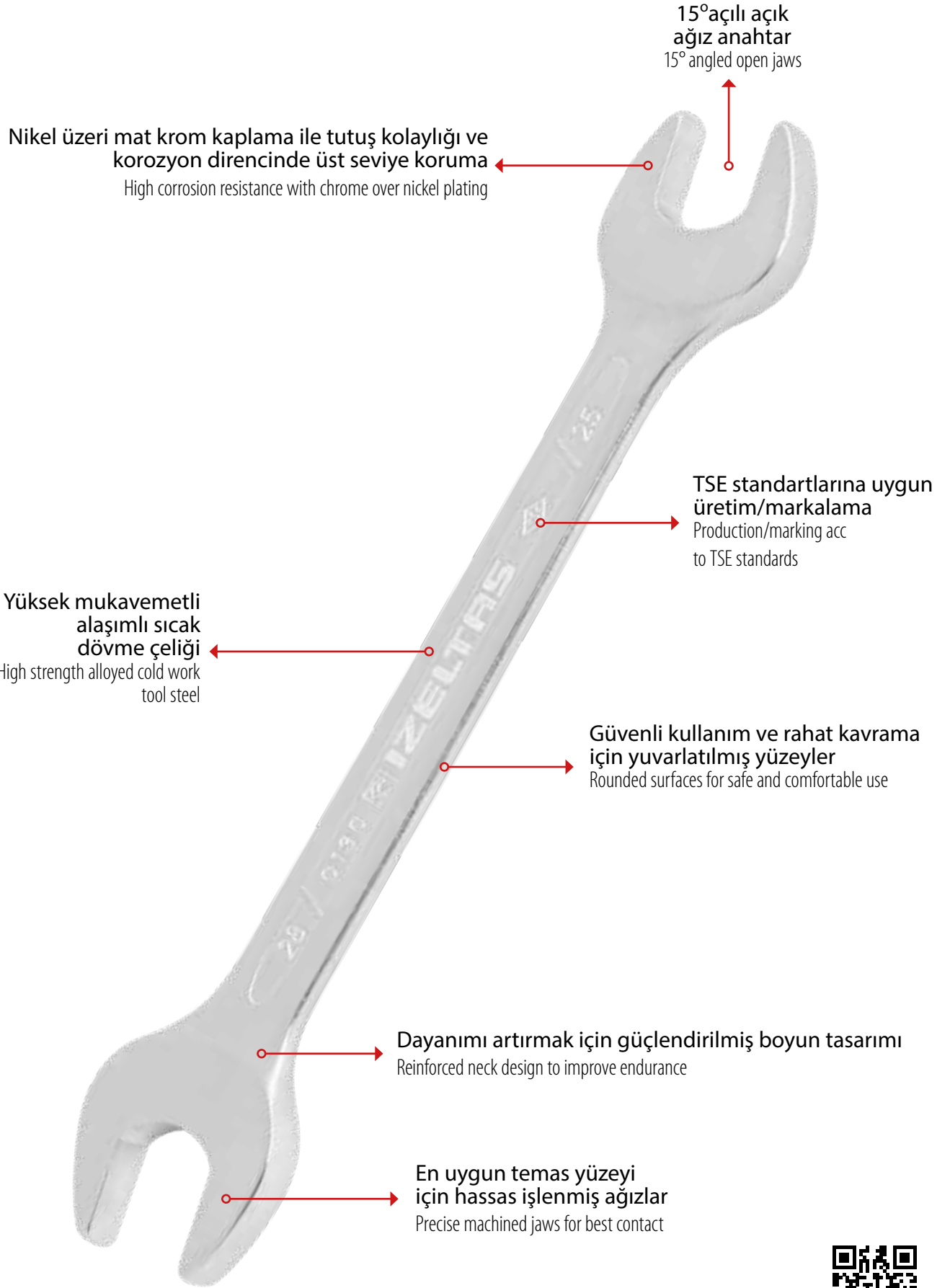

İZELTAS YOUTUBE

(★) İşaretili olan ürünler stoklarla sınırlıdır.

İki Ağız Anahtar Kısa Boy (mm)
Double Ended Open Jaw Wrench Short Pattern (mm)

 TS 81-6
DIN 895

IZELTAS YOUTUBE

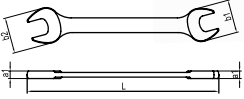
 Krom vanadyum, Krom kaplı
Chrom vanadium, Chrom plated

0100
İki Ağız Anahtar Takımı Kısa Boy (mm)
Double Ended Open Jaw Wrench Short Pattern Set (mm)

KOD CODE	mm	L mm	a1 mm	b1 mm	b2 mm	g	TL/Ad.
0100 01 0405	4x5	97	3.5	11	12.5	15	21,90
0100 01 0607	6x7	97	3.5	14	16	18	22,35
0100 01 0809	8x9	108	4	18	20	30	23,00
0100 01 0810	8x10	117	4.5	18	22	33	25,30
0100 01 1011	10x11	120	4.6	22	24	41	25,05
0100 01 1012	10x12	120	4.6	22	26	35	25,05
0100 01 1013	10x13	120	4.6	22	28	38	26,85
0100 01 1213	12x13	133	5.2	26	28	57	27,55
0100 01 1214	12x14	147	5.2	26	30	59	27,55
0100 01 1314	13x14	147	5.2	28	30	66	27,55
0100 01 1415	14x15	147	5.8	30	32	78	31,85
0100 01 1317	13x17	162	6.2	28	36	80	36,25
0100 01 1417	14x17	162	6.2	30	36	90	37,20
0100 01 1617	16x17	162	6.2	34	36	109	37,20
0100 01 1719	17x19	178	7	36	40	143	39,85
0100 01 1819	18x19	178	7	38	40	144	39,85
0100 01 1922	19x22	195	7.4	40	46	175	45,00
0100 01 2022	20x22	195	7.4	42	46	196	46,60
0100 01 2123	21x23	213	7.7	44	48	230	48,80
0100 01 2224	22x24	213	8	46	50	239	50,90
0100 01 2426	24x26	232	8.2	50	54	297	52,35
0100 01 2427	24x27	232	8.2	50	56	296	52,35
0100 01 2528	25x28	248	8.6	52	57.5	366	65,10
0100 01 2732	27x32	265	9	56	66	415	77,55
0100 01 3032	30x32	265	9	62	66	465	77,55

ÖZEL SERİLER (adet ve termin süresi isteyiniz)
SPECIAL SERIES (ask for quantity and delivery terms)

0100 01 0608	6x8	97	3.5	14	18	20	24,90
0100 01 0708	7x8	108	3.5	16	18	20	24,90
0100 01 0709	7x9	108	4	16	20	25	24,90
0100 01 0910	9x10	117	4.6	20	22	30	26,00
0100 01 0911	9x11	120	4.6	20	24	30	27,60
0100 01 1014	10x14	120	5.2	22	30	50	31,30
0100 01 1113	11x13	133	5.2	26	28	50	27,55
0100 01 1114	11x14	133	5.2	26	28	50	32,00
0100 01 1315	13x15	147	5.2	28	30	65	31,85
0100 01 1722	17x22	195	7.4	36	46	160	49,50
0100 01 1820	18x20	178	7	38	40	125	49,50
0100 01 1822	18x22	195	7.4	40	46	160	49,50
0100 01 1924	19x24	213	7.7	40	50	200	51,55
0100 01 2226	22x26	232	8	46	54	250	56,85
0100 01 2227	22x27	232	8.2	46	56	260	56,85
0100 01 2430	24x30	265	9	50	62	370	82,00
0100 01 2730	27x30	265	9	56	62	380	82,00

KOD CODE	İÇERİK CONTENTS	g	TL/Ad.
0100 00 2108	6x7 - 8x9 - 10x11 12x13 - 14x15 - 16x17 18x19 - 20x22	736	8 253,45
0100 00 2112	6x7 - 8x9 - 10x11 12x13 - 14x15 - 16x17 18x19 - 20x22 - 21x23 24x26 - 25x28 - 30x32	2110	12 497,25

(*) İşaretili olan ürünler stoklarla sınırlıdır.

İki Ağız Anahtar Uzun Boy (mm)

Double Ended Open Jaw Wrench Long Pattern (mm)

TS ISO 10102
DIN 3110

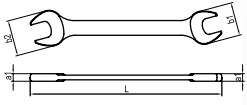

Krom vanadyum, Krom kaplı
Chrom vanadium, Chrom plated

KOD CODE	mm	L mm	a1 mm	b1 mm	b2 mm	g	TL/Ad.	
0130 01 0607	6x7	125	3.5	14	16	24	10	28,55
0130 01 0608	6x8	125	3.5	14	18	20	10	29,55
0130 01 0809	8x9	140	4	18	20	35	10	29,55
0130 01 0810	8x10	140	4	18	22	36	10	29,55
0130 01 1011	10x11	155	4.5	22	24	47	10	32,65
0130 01 1012	10x12	162	4.7	22	26	57	10	32,65
0130 01 1013	10x13	162	4.7	22	28	61	10	32,65
0130 01 1014	10x14	162	4.7	22	28	65	10	32,65
0130 01 1113	11x13	172	5	26	28	70	10	32,65
0130 01 1114	11x14	172	5	26	30	65	10	32,65
0130 01 1213	12x13	172	5	26	28	67	10	34,40
0130 01 1214	12x14	172	5	26	30	65	10	34,40
0130 01 1314	13x14	188	5.5	28	30	85	10	34,40
0130 01 1315	13x15	188	5.5	30	32	93	10	34,40
0130 01 1415	14x15	188	5.5	30	32	91	10	39,90
0130 01 1317	13x17	205	6.2	28	36	111	10	43,60
0130 01 1417	14x17	205	6.2	30	36	106	10	43,60
0130 01 1617	16x17	205	6.2	34	36	120	10	44,10
0130 01 1618	16x18	220	7	36	40	165	10	47,05
0130 01 1719	17x19	220	7	36	40	160	10	47,05
0130 01 1819	18x19	220	7	38	40	161	10	47,05
0130 01 1921	19x21	235	7.5	40	46	195	5	54,80
0130 01 1922	19x22	235	7.5	40	46	195	5	54,80
0130 01 2022	20x22	235	7.5	42	46	195	5	54,80
0130 01 1924	19x24	248	8.3	40	50	235	5	55,05
0130 01 2123	21x23	248	8.3	44	48	235	5	55,90
0130 01 2224	22x24	248	8.3	46	50	235	5	59,40
0130 01 2426	24x26	265	8.8	50	54	300	5	68,00
0130 01 2427	24x27	265	8.8	50	56	300	5	68,00
0130 01 2430	24x30	282	9.3	50	61.5	380	5	76,05
0130 01 2528	25x28	282	9.3	52	57.5	390	5	76,05
0130 01 2729	27x29	300	9.8	56	59	400	5	95,00
0130 01 2730	27x30	300	9.8	56	59	440	5	95,00
0130 01 2732	27x32	300	9.8	56	65.5	460	5	95,00
0130 01 3032	30x32	300	9.8	61.5	65.5	480	5	95,00
0130 01 3036	30x36	325	10.4	61.5	76	645	5	180,10
0130 01 3236	32x36	325	10.4	65.5	76	680	5	180,10
0130 01 3436	34x36	330	10.4	71	76	690	5	180,10
0130 01 3641	36x41	360	12	76	87	955	5	279,75
0130 01 4146	41x46	400	12.5	87	98	1300	5	431,30
0130 01 4650	46x50	450	13	98	107	1635	5	478,35

ÖZEL SERİLER (adet ve termin süresi isteyiniz)

SPECIAL SERIES (ask for quantity and delivery terms)

0130 01 0555	5x5.5	125	3.5	14	16	15	10	22,35
0130 01 0708	7x8	135	3.5	16	18	20	10	29,55
0130 01 0709	7x9	140	4	16	20	30	10	29,55
0130 01 0910	9x10	140	4	18	22	45	10	32,65
0130 01 0911	9x11	155	4.5	22	24	45	10	32,65
0130 01 1722	17x22	235	7.5	36	46	190	5	54,80
0130 01 1724	17x24	248	8.3	36	50	240	5	55,05
0130 01 2227	22x27	265	8.8	46	56	300	5	68,00

0130

İki Ağız Anahtar Takımı Uzun Boy (mm)

Double Ended Open Jaw Wrench
Long Pattern Set (mm)

TS ISO 10102
DIN 3110



KOD CODE	İÇERİK CONTENTS	g	TL/Ad.	
0130 00 2108	6x7 - 8x9 - 10x11 - 12x13 14x15 - 16x17 - 18x19 20x22	815	8	311,00
0130 00 2112	6x7 - 8x9 - 10x11 12x13 - 14x15 - 16x17 18x19 - 20x22 - 21x23 24x26 - 25x28 - 27x32	2315	12	605,95

(★) İşaretili olan ürünler stoklarla sınırlıdır.

0161

İki Ağız Anahtar Uzun Boy (SAE)

Double Ended Open Jaw Wrench Long Pattern (SAE)

TSEK

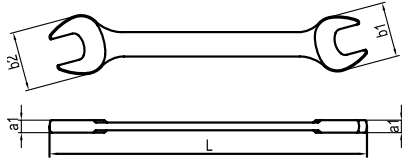

Krom vanadyum, Krom kaplı
Chrom vanadium, Chrom plated

KOD CODE	inch	L mm	a1 mm	b1 mm	b2 mm	g	TL/Ad.	
0161 01 0608	1/4"x5/16"	125	3.5	18	16	18	10	35,35
0161 01 0809	5/16"x3/8"	140	4	18	20	30	10	35,35
0161 01 0810	5/16"x11/32"	140	4	18	20	30	10	35,35
0161 01 0811	5/16"x7/16"	140	4	18	22	30	10	35,35
0161 01 0911	3/8"x7/16"	155	4.5	22	24	35	10	39,20
0161 01 1112	7/16"x1/2"	172	5	26	28	40	10	39,20
0161 01 1214	1/2"x9/16"	172	5	26	30	65	10	41,25
0161 01 1416	9/16"x5/8"	188	5.5	30	32	85	10	47,95
0161 01 1417	9/16"x11/16"	205	6.2	30	36	110	10	52,30
0161 01 1517	19/32"x11/16"	205	6.2	34	36	115	10	52,80
0161 01 1619	5/8"x3/4"	220	7	36	40	150	10	56,45
0161 01 1920	3/4"x25/32"	220	7	38	40	160	10	56,45
0161 01 2021	25/32"x13/16"	235	7.5	40	46	195	10	65,60
0161 01 1922	3/4"x7/8"	235	7.5	40	46	195	10	65,60
0161 01 2122	13/16"x7/8"	248	8.3	44	48	235	10	66,90
0161 01 2325	15/16"x1"	265	8.8	50	54	300	10	78,85
0161 01 2328	15/16"x1 1/8"	265	8.8	50	56	300	10	79,75
0161 01 2628	1 1/16"x1 1/8"	300	9.8	56	59.5	460	10	114,60
0161 01 2631	1 1/16"x1 1/4"	300	9.8	56	65.5	460	10	121,00
0161 01 2833	1 1/8"x1 5/16"	300	9.8	56	65.5	460	10	121,00

0161

İki Ağız Anahtar Takımı Uzun Boy (SAE)

Double Ended Open Jaw Wrench
Long Pattern Set (SAE)

TSEK



KOD CODE	İÇERİK CONTENTS	g	TL/Ad.	
0161 00 2108	1/4"x5/16" - 5/16"x3/8" 7/16"x1/2" - 9/16"x5/8" - 19/32"x11/16" 3/4"x25/32" - 13/16"x7/8" - 15/16"x1"	1090	8	412,85
0161 00 2112	1/4"x5/16" - 5/16"x3/8" - 3/8"x7/16" 7/16"x1/2" - 1/2"x9/16" - 9/16"x5/8" 19/32"x11/16" - 3/4"x25/32" - 13/16"x7/8" 15/16"x1" - 1 1/16"x1 1/4" 1 1/8"x1 5/16"	2165	12	735,30

(*) İşaretili olan ürünler stoklarla sınırlıdır.

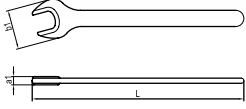
Bir Ağız Taçlı Anahtar (mm)
Single Ended Open Jaw Wrench (mm)

Krom vanadyum
Chrom vanadium

KOD CODE	mm	L mm	a1 mm	b1 mm	g	TL/Ad.
0250 01 0030	30	260	10.5	60	250	1 131,20
0250 01 0036	36	300	10.5	74.5	370	1 165,65
0250 01 0041	41	345	12.2	85.5	550	1 216,25
0250 01 0046	46	390	14	96.5	750	1 232,75
0250 01 0050	50	423	15.2	105	1000	1 290,65
0250 01 0055	55	455	16.5	113.5	1300	1 389,35
0250 01 0060	60	490	17.6	121	1600	1 498,60
0250 01 0065	65	524	19	130	1980	1 607,85

ÖZEL SERİLER (adet ve termin süresi isteyiniz)
SPECIAL SERIES (ask for quantity and delivery terms)

0250 01 0021	21	185	8	42.4	95	1	----
0250 01 0022	22	195	8	44.4	110	1	----
0250 01 0023	23	195	8	46.3	115	1	----
0250 01 0024	24	215	9	48.3	150	1	----
0250 01 0025	25	215	9	50.3	155	1	----
0250 01 0027	27	240	9.5	54.3	200	1	----
0250 01 0032	32	274	11	63	300	1	----
0250 01 0034	34	274	11	68	320	1	----
0250 01 0038	38	300	10.5	76.8	400	1	----
0250 01 0070	70	564	20.8	140	2480	1	----
0250 01 0075	75	608	21.8	151	3100	1	----

Süper İzole Çatal Bir Ağız Anahtar (mm)
Single Ended Open Jaw Wrench Super Insulated (mm)

 IEC 60900
 ⚡ 1000 V

Krom vanadyum, Krom kaplı, Kalın PVC izoleli
Chrom vanadium, Chrom plated, Triple PVC insulated

KOD CODE	mm	L mm	g	TL/Ad.
0255 01 0010	10	110	40	10 76,75
0255 01 0011	11	120	45	10 81,05
0255 01 0012	12	130	50	10 84,65
0255 01 0013	13	140	60	10 91,10
0255 01 0014	14	155	75	10 94,55
0255 01 0017	17	170	100	10 116,05
0255 01 0019	19	185	150	10 136,20
0255 01 0022	22	200	200	10 183,20
0255 01 0024	24	220	280	10 224,15

Montaj Anahtar (mm)
Speed Wrench (mm)

IZELTAS YOUTUBE

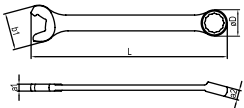
Krom vanadyum, Krom kaplı
Chrom vanadium, Chrom plated

KOD CODE	mm	L mm	a1 mm	a2 mm	b1 mm	ØD mm	g	TL/Ad.
0325 02 0010	10	135	4.3	6.9	22	15.5	35	10 49,15
0325 02 0013	13	165	5.2	7.9	28	19.5	45	10 55,05
0325 02 0017	17	205	6.4	9.8	36	25.5	110	10 72,80
0325 02 0019	19	225	7	11	40	28.5	155	10 85,25
0325 02 0020	20	230	7.2	11.4	42	30	180	10 86,85
0325 02 0021	21	242	7.4	12	44	31.5	180	10 100,95
0325 02 0022	22	250	8.2	12.6	46	33	245	10 115,60

%100 Daha Hızlı

Yeni tasarlanan montaj anahtarları, 2 kat hızlıncırcı mekanizması mantığına dayanan çalışma prensibinden alır. Kullanım sırasında, montaj anahtarını civatadan ayırmadan döndürme kolaylığı kullanım hızını arttırırken, civata köşelerine sağlam tutunan anahtar profili güvenli ve kaydırmaz kullanım sağlar.

Uzun Ömür

Bu yeni montaj anahtarları profili, civata ve somunlar ile köşelerinden değil düz yüzeyleri üzerinden temas ederek düzenli tork iletimini sağlarken, gerilimin artmasını da engelleyerek anahtar ömrünün uzamasını sağlar.

• Anahtarları civatadan ayırmadan hızlı kullanılır.

• Güvenli tork iletimi ve uzun ömür.

100% Faster

The 100% new design speed wrench takes the 2-fold speed from the operating principle based on the ratchet mechanism logic. While in use, the ease of rotation without detaching the mounting wrench from the bolt increases the speed of use and the profile that firmly secured to the corners ensures safe and non-slip use

Long Life

This new mounting wrench profile by contacting bolts and nuts, not on corners, but on their flat surfaces, allows regular torx transmission, prevents the increase in surface tension and provides longer life.

• Quick use without detaching the wrench from the bolt.

• Safe torx transmission and long life.

Kombine Anahtar Kısa Boy (mm)
Combination Wrench Short Pattern (mm)

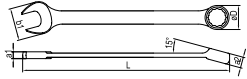
 TS 3794
 TS ISO 7738 Form A
 DIN 3113

 Krom vanadyum, Krom kaplı
 Chrom vanadium, Chrom plated

KOD CODE	mm	L mm	a1 mm	a2 mm	b1 mm	øD mm	g	TL/Ad.	
0320 02 0005	5	90	3.4	5.1	14	10	15	10	28,55
0320 02 0055	5.5	90	3.4	5.1	14	10	15	10	28,55
0320 02 0006	6	100	3.4	5.1	14	10	15	10	29,55
0320 02 0007	7	110	3.6	5.5	16	11	20	10	31,40
0320 02 0008	8	120	3.8	5.9	18	13	25	10	34,20
0320 02 0009	9	130	4	6.3	20	14	30	10	34,95
0320 02 0010	10	140	4.3	6.9	22	15.5	40	10	39,45
0320 02 0011	11	150	4.5	7.3	24	17	45	10	40,45
0320 02 0012	12	160	4.9	7.7	26	18.5	55	10	43,15
0320 02 0013	13	170	5.2	7.9	28	19.5	60	10	44,10
0320 02 0014	14	180	5.5	8.7	30	21.5	75	10	47,70
0320 02 0015	15	190	5.8	9.1	32	22.5	90	10	51,05
0320 02 0016	16	200	6.1	9.6	34	24	105	10	54,80
0320 02 0017	17	210	6.4	9.8	36	25.5	120	10	58,40
0320 02 0018	18	220	6.8	10.4	38	27	145	10	65,15
0320 02 0019	19	232	7	11	40	28.5	170	10	68,55
0320 02 0020	20	240	7.2	11.4	42	30	195	10	69,85
0320 02 0021	21	250	7.4	12	44	31.5	190	10	81,05
0320 02 0022	22	260	8.2	12.6	46	33	275	10	92,50
0320 02 0023	23	270	8.3	13	48	35	255	5	92,50
0320 02 0024	24	280	8.5	13.6	50	36.5	320	5	113,25
0320 02 0025	25	290	8.8	14	52	39	320	5	113,25
0320 02 0026	26	300	9	14.8	54	41	400	5	133,40
0320 02 0027	27	310	9.3	15	56	41.5	400	5	133,40
0320 02 0028	28	320	9.4	15.4	57.5	42.5	380	5	133,40
0320 02 0029	29	330	10	15.6	59	43.5	510	5	152,75
0320 02 0030	30	340	10.3	16	61.5	44	505	5	152,75
0320 02 0032	32	370	10.5	16.2	65.5	47	560	5	160,60
0320 02 0034	34	400	10.7	16.8	71	50	675	5	167,75

0320
Kombine Anahtar Takımı Kısa Boy (mm)
Combination Wrench Short Pattern Set (mm)

KOD CODE	İÇERİK CONTENTS	g	TL/Ad.	
0320 00 2108	6 - 7 - 8 - 9 - 10 - 13 - 17 - 19	475	8	340,60
0320 00 2112	8 - 9 - 10 - 11 - 12 - 13 - 14 15 - 16 - 17 - 19 - 22	1190	12	609,30
0320 00 2117	6 - 7 - 8 - 9 - 10 - 11 - 12 - 13 - 14 15 - 16 - 17 - 18 - 19 - 20 - 21 - 22	1760	17	886,30
0320 00 2121	6 - 7 - 8 - 9 - 10 - 11 - 12 - 13 - 14 15 - 16 - 17 - 18 - 19 - 20 - 21 - 22 24 - 27 - 30 - 32	3650	21	1446,30

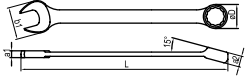
(★) İşaretili olan ürünler stoklarla sınırlıdır.

Kombine Anahtar Uzun Boy (mm)
Combination Wrench, Long Pattern (mm)

 Krom vanadyum, Krom kaplı
 Chrom vanadium, Chrom plated

KOD CODE	mm	L mm	a1 mm	a2 mm	b1 mm	øD mm	g	TL/Ad.	
0330 02 0005	5	95	3.2	5.2	12.5	9	20	10	32,90
0330 02 0055	5.5	95	3.2	5.2	12.5	9	20	10	32,90
0330 02 0006	6	105	3.8	5.6	14	10.5	20	10	32,90
0330 02 0007	7	117	4	6.1	16	12	20	10	32,90
0330 02 0008	8	130	4.2	6.6	18	13.5	30	10	38,50
0330 02 0009	9	141	4.5	7	20	15	40	10	39,00
0330 02 0010	10	154	4.7	7.6	22	16	50	10	43,15
0330 02 0011	11	166	5	8.2	24	17.5	60	10	45,60
0330 02 0012	12	178	5.2	8.7	26	19	70	10	45,60
0330 02 0013	13	190	5.6	9.2	28	20.5	80	10	51,10
0330 02 0014	14	203	5.8	9.7	30	22	100	10	53,20
0330 02 0015	15	215	6.4	10.1	32	23.5	115	10	56,80
0330 02 0016	16	227	6.4	10.8	34	25	135	10	57,35
0330 02 0017	17	239	6.6	11.4	36	26.5	160	10	65,15
0330 02 0018	18	250	7	12	38	28	186	10	70,30
0330 02 0019	19	263	7.3	12.7	40	29.5	205	10	76,35
0330 02 0020	20	275	7.7	13.2	42	31	235	10	81,25
0330 02 0021	21	288	8.1	13.3	44	31.5	260	10	86,35
0330 02 0022	22	300	8.5	13.7	46	34	300	10	102,95
0330 02 0023	23	315	8.8	14.2	48	35.5	300	5	125,65
0330 02 0024	24	330	9	14.2	50	37	390	5	125,65
0330 02 0025	25	340	9.3	14.7	52	38.5	380	5	125,65
0330 02 0026	26	350	9.7	14.7	54	40	475	5	148,00
0330 02 0027	27	360	10	15.2	56	41	475	5	148,00
0330 02 0028	28	370	10.4	15.7	57.5	43	475	5	148,00
0330 02 0029	29	390	10.8	16.2	59	44	610	5	148,00
0330 02 0030	30	410	11.2	16.6	61.5	45	610	5	169,95
0330 02 0032	32	420	11.5	17.1	65.5	48	755	5	178,20
0330 02 0034	34	430	11.8	17.4	71	50.5	735	5	181,65
0330 02 0036	36	440	12.2	17.7	76	53	1000	5	205,80
0330 02 0038	38	450	12.5	18.7	80	56	1000	5	210,60
0330 02 0041	41	480	13.5	19.7	87	61	1240	5	239,65
0330 02 0046	46	505	14.7	20.7	95	67.5	1635	1	325,60
0330 02 0050	50	540	15.9	22.7	104	73.5	2100	1	441,50

0330
Kombine Anahtar Takımı Uzun Boy (mm)
Combination Wrench Long Pattern Set (mm)

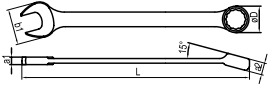
KOD CODE	İÇERİK CONTENTS	g	TL/Ad.	
0330 00 2108	6 - 7 - 8 - 9 - 10 - 13 17 - 19	665	8	379,05
0330 00 2112	8 - 9 - 10 - 11 - 12 13 - 14 - 15 - 16 17 - 19 - 22	1780	12	674,75
0330 00 2117	6 - 7 - 8 - 9 - 10 11 - 12 - 13 - 14 - 15 16 - 17 - 18 - 19 20 - 21 - 22	2170	17	978,45
0330 00 2121	6 - 7 - 8 - 9 - 10 - 11 12 - 13 - 14 - 15 - 16 17 - 18 - 19 - 20 - 21 22 - 24 - 27 - 30 - 32	4465	21	1600,25

Kombine Anahtar Uzun Boy (SAE)
Combination Wrench Long Pattern (SAE)
TSEK

Krom vanadyum, Krom kaplı
Chrom vanadium, Chrom plated

KOD CODE	inch	L mm	a1 mm	a2 mm	b1 mm	øD mm	g	TL/Ad.
0331 02 0005	3/16"	95	3.2	5.2	12.5	9	15	39,45
0331 02 0006	1/4"	105	3.8	5.6	14	10.5	20	41,10
0331 02 0008	5/16"	130	4.2	6.6	18	13.5	30	47,85
0331 02 0010	3/8"	154	4.7	7.6	22	16	50	54,55
0331 02 0011	7/16"	166	5	8.2	24	17.5	60	57,25
0331 02 0013	1/2"	190	5.6	9.2	28	20.5	80	64,55
0331 02 0014	9/16"	203	5.8	9.7	30	22	100	67,85
0331 02 0015	19/32"	215	6.4	10.1	32	23.5	115	71,90
0331 02 0016	5/8"	227	6.4	10.8	34	25	135	77,25
0331 02 0017	11/16"	239	6.6	11.4	36	26.5	155	82,35
0331 02 0019	3/4"	263	7.3	12.7	40	29.5	205	95,90
0331 02 0020	25/32"	275	7.7	13.2	42	31	230	102,60
0331 02 0021	13/16"	288	8.1	13.3	44	31.5	260	113,30
0331 02 0022	7/8"	300	8.5	13.7	46	34	310	130,50
0331 02 0024	15/16"	330	9	14.2	50	37	380	159,65
0331 02 0025	1"	340	9.3	14.7	52	38.5	380	159,65
0331 02 0027	1 1/16"	360	10	15.2	56	41	470	186,85
0331 02 0028	1 1/8"	370	10.4	15.7	57.5	43	470	186,85
0331 02 0030	1 3/16"	410	11.2	16.6	61.5	45	635	214,05
0331 02 0032	1 1/4"	420	11.5	17.1	65.5	48	775	224,35
0331 02 0033	1 5/16"	430	11.8	17.4	71	50.5	775	224,35
0331 02 0038	1 1/2"	450	12.5	18.7	80	56	1015	271,20

ÖZEL SERİLER (adet ve termin süresi isteyiniz)
SPECIAL SERIES (ask for quantity and delivery terms)

0331 02 0035	1 3/8"	440	12.2	17.7	76	53	1015	5	246,55
0331 02 0036	1 7/16"	440	12.2	17.7	76	53	1015	5	246,55
0331 02 0041	1 5/8"	480	13.5	19.7	87	61	1325	5	287,40
0331 02 0046	1 13/16"	505	14.7	20.7	95	67.5	1750	5	390,65
0331 02 0050	2"	540	15.9	22.7	104	73.5	2200	5	529,70

0331
Kombine Anahtar Takımı Uzun Boy (SAE)
Combination Wrench Long Pattern Set (SAE)

KOD CODE	İÇERİK CONTENTS	g	TL/Ad.
0331 00 2108	5/16" - 3/8" - 7/16" - 1/2" - 9/16" - 5/8" - 11/16" - 3/4"	925	8 547,55
0331 00 2112	5/16" - 3/8" - 7/16" - 1/2" - 9/16" - 5/8" - 11/16" - 3/4" - 13/16" - 7/8" - 15/16" - 1"	2320	12 1110,65
0331 00 2117	1/4" - 5/16" - 3/8" - 7/16" - 1/2" - 9/16" - 19/32" - 5/8" - 11/16" - 3/4" - 25/32" - 13/16" - 7/8" - 15/16" - 1" - 1 1/16" - 1 3/16"	3875	17 1727,15
0331 00 2120	1/4" - 5/16" - 3/8" - 7/16" - 1/2" - 9/16" - 19/32" - 5/8" - 11/16" - 3/4" - 25/32" - 13/16" - 7/8" - 15/16" - 1" - 1 1/16" - 1 1/8" - 1 3/16" - 1 1/4" - 1 5/16"	5880	20 2362,70

(★) İşaretili olan ürünler stoklarla sınırlıdır.

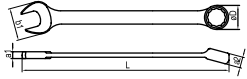
Cırcır Kombine Anahtar (mm)
Combination Wrench With Ratchet (mm)

Krom vanadyum, Krom kaplı
Chrom vanadium, Chrom plated

KOD CODE	mm	L mm	a1 mm	a2 mm	b1 mm	øD mm	g		TL/Ad.
0340 02 0008	8	140	4.9	6.4	16.9	17.1	35	10	140,05
0340 02 0009	9	149	5	6.7	19.7	19.1	40	10	139,75
0340 02 0010	10	159	5	7	21.1	20.3	55	10	146,60
0340 02 0011	11	165	5.3	7.3	24	22.5	70	10	147,35
0340 02 0012	12	171	5.6	7.6	26.5	23.5	80	10	159,65
0340 02 0013	13	178	5.9	8.1	27.7	25.3	90	10	171,10
0340 02 0014	14	190	6.3	8.5	30.7	27.5	120	10	176,25
0340 02 0015	15	199	6.7	9	32	28.8	135	10	186,85
0340 02 0016	16	208	6.7	9.5	34	30.3	155	10	214,10
0340 02 0017	17	225	7	10	36.2	32.2	190	10	226,60
0340 02 0018	18	236	7.7	10.5	38.2	33.3	200	10	245,65
0340 02 0019	19	248	8.3	11	40.4	35	240	10	260,90
0340 02 0021	21	288	9.4	13	45.7	40.7	350	10	363,05
0340 02 0022	22	288	9.4	13	45.7	40.7	340	10	398,15
0340 02 0024	24	321	10.5	14.5	52	46.2	470	5	449,75

0340
Cırcır Kombine Anahtar Takımı (mm)
Combination Wrench With Ratchet, Set (mm)

0335
Çoklu Yıldız Cırcır Anahtar (mm)
Multi-Ring Wrench (mm)

Krom vanadyum, Krom kaplı
Chrom vanadium, Chrom plated

KOD CODE	ÖLÇÜ SIZE	L mm	g		TL/Ad.
0335 02 0010	10x13x17x19	230	215	5	519,20

KOD CODE	İÇERİK CONTENTS	g		TL/Ad.
0340 00 2110	8 - 9 - 10 - 11 12 - 13 - 14 - 15 17 - 19	1315	10	1755,10
0340 00 2115	8 - 9 - 10 - 11 - 12 - 13 14 - 15 - 16 - 17 - 18 19 - 21 - 22 - 24	2445	15	3425,80

(*) İşaretili olan ürünler stoklarla sınırlıdır.

0345

Mafsallı Cırcır Kombine Anahtar (mm) Flexible Head Combination Wrench With Ratchet (mm)

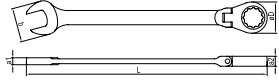

Krom vanadyum, Krom kaplı
Chrom vanadium, Chrom plated

KOD CODE	mm	L mm	a1 mm	a2 mm	b mm	ØD mm	g		TL/Ad.
0345 02 0008	8	136	5.5	7	17	17.5	40	10	231,80
0345 02 0009	9	140	6.1	7.7	21.5	21	50	10	236,40
0345 02 0010	10	140	6.1	7.7	21.5	21	60	10	245,90
0345 02 0011	11	142	6.4	8.3	23.5	22.5	80	10	253,65
0345 02 0012	12	143	6.7	8.7	26	24	90	10	268,10
0345 02 0013	13	156	7	9.3	27	26	105	10	279,60
0345 02 0014	14	164	7.3	9.4	30.5	27.5	125	10	294,05
0345 02 0015	15	174	7.7	10	32	29	145	10	308,55
0345 02 0016	16	176	8	10.6	34	30.5	185	10	335,70
0345 02 0017	17	195	8.3	10.9	37	32.5	210	10	340,10
0345 02 0018	18	213	8.6	11.2	38.5	33.5	235	10	366,20
0345 02 0019	19	214	9	11.5	40	35	260	10	382,60

0345

Mafsallı Cırcır Kombine Anahtar Takımı (mm) Flexible Head Combination Wrench With Ratchet, Set (mm)



KOD CODE	İÇERİK CONTENTS	g		TL/Ad.
0345 00 2112	8 - 9 - 10 - 11 - 12 - 13 14 - 15 - 16 - 17 - 18 - 19	1365	12	3542,65

(*) İşaretili olan ürünler stoklarla sınırlıdır.

Boyunlu Kombine Anahtar (mm)
Offset Combination Wrench (mm)

TS 3794
TS ISO 7738 Form B
DIN 3113

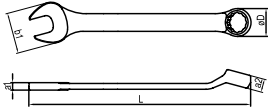

Krom vanadyum, Krom kaplı
Chrom vanadium, Chrom plated

0370
Boyunlu Kombine Anahtar Takımı (mm)
Offset Combination Wrench, Set (mm)

KOD CODE	mm	L mm	a1 mm	a2 mm	b1 mm	σD mm	g	TL/Ad.	
0370 02 0006	6	110	3.8	5.6	16	10.5	20	10	33,95
0370 02 0007	7	120	4	6.2	18	12	25	10	36,20
0370 02 0008	8	130	4.2	6.7	20	13	30	10	39,20
0370 02 0009	9	140	4.4	7.3	22	14.5	35	10	40,10
0370 02 0010	10	150	4.6	7.8	24	16	40	10	45,40
0370 02 0011	11	160	4.8	8.4	26	17	50	10	46,75
0370 02 0012	12	167	5	9	28	18.5	65	10	50,15
0370 02 0013	13	175	5.4	9.6	30	20	75	10	51,40
0370 02 0014	14	185	5.8	10.2	32	21.5	90	10	55,05
0370 02 0015	15	195	6.2	10.8	34	23	105	10	58,60
0370 02 0016	16	210	6.6	11.4	36	24.5	120	10	62,95
0370 02 0017	17	225	7	12	38	26	160	10	67,15
0370 02 0018	18	237	7.4	12.4	40	27.5	170	10	74,95
0370 02 0019	19	250	7.8	13	42	29	200	10	78,85
0370 02 0020	20	267	8.2	13.2	44	30.5	230	10	82,85
0370 02 0021	21	283	8.6	13.8	46	32	265	10	93,15
0370 02 0022	22	295	9.1	14.6	48	34.5	300	10	106,65
0370 02 0023	23	295	9.1	14.6	48	34.5	300	5	130,35
0370 02 0024	24	329	9.4	15.4	52	37	380	5	130,35
0370 02 0025	25	329	9.4	15.4	52	37	380	5	130,35
0370 02 0026	26	360	10.2	16.8	58	41	485	5	153,35
0370 02 0027	27	360	10.2	16.8	58	41	475	5	153,35
0370 02 0028	28	360	10.2	16.8	58	41	470	5	153,35
0370 02 0029	29	394	11	18.2	64	44.5	610	5	170,85
0370 02 0030	30	394	11	18.2	64	44.5	620	5	176,10
0370 02 0032	32	435	11.8	19.7	66	47.5	765	5	184,80
0370 02 0036	36	468	12.6	21.2	76	53	1020	5	213,60

KOD CODE	İÇERİK CONTENTS	g	TL/Ad.	
0370 00 2108	6 - 7 - 8 - 9 - 10 - 13 - 17 - 19	665	8	392,25
0370 00 2112	8 - 9 - 10 - 11 - 12 - 13 - 14 15 - 16 - 17 - 19 - 22	1375	12	702,25
0370 00 2117	6 - 7 - 8 - 9 - 10 - 11 - 12 - 13 - 14 15 - 16 - 17 - 18 - 19 - 20 - 21 - 22	2100	17	1023,35
0370 00 2121	6 - 7 - 8 - 9 - 10 - 11 - 12 - 13 - 14 - 15 16 - 17 - 18 - 19 - 20 - 21 - 22 - 24 - 27 30 - 32	4425	21	1667,95

(★) İşaretili olan ürünler stoklarla sınırlıdır.

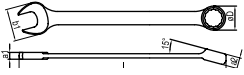
Torx® - mm Kombine Anahtar
Torx®- mm Combination Wrench

Krom vanadyum, Krom kaplı
 Chrom vanadium, Chrom plated

KOD CODE	mm	*	L mm	a1 mm	a2 mm	b1 mm	øD mm	g	TL/ Ad.	
0380 02 0008	8	E10	170	4.5	7.5	20.5	13	45	10	68,30
0380 02 0009	9	E12	180	4.5	8	22.5	14.5	45	10	69,40
0380 02 0010	10	E14	190	5	8.5	24.5	16	60	10	76,95
0380 02 0011	11	E14	200	5.5	9	26.5	17	75	10	81,10
0380 02 0012	12	E16	210	6	9.5	28.5	19	90	10	83,30
0380 02 0013	13	E18	225	6.5	10	30.5	20	110	10	91,40
0380 02 0014	14	E18	235	7	11	32.5	22	120	10	101,15
0380 02 0015	15	E20	250	7.5	12	34.5	23	150	10	107,05
0380 02 0017	17	E22	280	8.5	14	38.5	26.5	210	10	116,25
0380 02 0018	18	E24	295	9	15	40.5	28	240	10	126,10
0380 02 0019	19	E24	310	9.5	16	42.5	29.5	280	10	136,60
0380 02 0022	22	E26	350	11	18	48.5	34.5	410	10	183,65

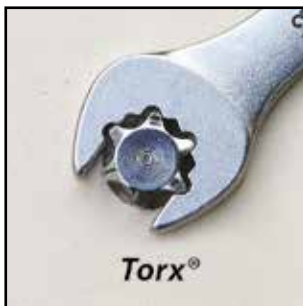
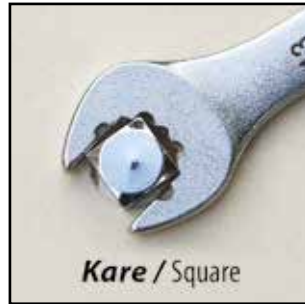
0380
Torx® - mm Kombine Anahtar Takımı
Torx®- mm Combination Wrench Set

Torx® - mm Kombine Anahtar: Bir çatal ağız ve bir yıldız ağızdan oluşan anahtarlarımız 8-22 mm arasında boyları bulunmaktadır. Çatal ağız kısmı mevcut çatal anahtarlardan farklı olarak 6 köşe avatanın yanısıra farklı geometri lere sahip avataları açabilmekte ve sıkabilmektedir.

TORX-mm combination wrench: Our wrenches consisting of an open end and a ring end are available in sizes from 8 to 22 mm. Unlike the existing open end wrenches, its open end can unbolt and tighten bolts with different geometries as well as the

KOD CODE	İÇERİK CONTENTS	g	TL/ Ad.
	8 - 9 - 10 - 11 - 12 - 13 - 17 - 19		
0380 00 2108	E10 - E12 - E14 - E14 E16 - E18 - E22 - E24	790	8 723,30
	8 - 9 - 10 - 11 - 12 - 13 14 - 15 - 17 - 18 - 19 - 22		
0380 00 2112	E10 - E12 - E14 - E14 - E16 - E18 E18 - E20 - E22 - E24 - E24 - E26	1590	12 1241,25

(*) İşaretli olan ürünler stoklarla sınırlıdır.

Yıldız İki Ağız Anahtar (mm)
Double Ended Ring Wrench (mm)

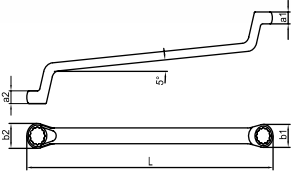
 TS 3794
 TS ISO 10104 Form B
 DIN 838

Krom vanadyum, Krom kaplı
Chrom vanadium, Chrom plated

KOD CODE	mm	L mm	a1 mm	a2 mm	b1 mm	b2 mm	g	TL/Ad.
0430 03 0607	6x7	176	5.6	6	10	11.5	55	10 51,10
0430 03 0809	8x9	190	6.4	6.8	13	14.5	75	10 51,85
0430 03 0810	8x10	190	6.4	7.3	13	15.5	70	10 51,85
0430 03 1011	10x11	206	7.3	7.6	15.5	17	105	10 57,35
0430 03 1012	10x12	206	7.3	8.5	15.5	18.5	105	10 57,35
0430 03 1013	10x13	220	7.3	9	15.5	20	120	10 65,15
0430 03 1113	11x13	220	8.5	9	18.5	20	130	10 65,15
0430 03 1213	12x13	220	8.5	9	18.5	20	135	10 65,15
0430 03 1214	12x14	220	8.5	9.5	18.5	23	145	10 65,15
0430 03 1415	14x15	236	9.5	10	21.5	23	180	10 68,55
0430 03 1317	13x17	250	9	11.5	20	26.5	215	10 77,65
0430 03 1417	14x17	250	9.5	11.5	21.5	26.5	210	10 77,65
0430 03 1617	16x17	250	10.8	11.5	25	26.5	220	10 77,65
0430 03 1618	16x18	260	10.8	12	25	27.5	210	10 92,25
0430 03 1719	17x19	271	11.5	12.5	26.5	29	270	10 92,25
0430 03 1819	18x19	271	12	12.5	27.5	29	270	10 92,25
0430 03 1922	19x22	291	12.5	13.5	29	33	330	5 101,25
0430 03 1924	19x24	311	12.5	14.2	29	36.5	345	5 101,25
0430 03 2022	20x22	291	12.9	13.5	30.5	33	330	5 101,25
0430 03 2123	21x23	311	13.1	14	32	35	410	5 116,05
0430 03 2224	22x24	321	13.5	14.2	33	36.5	410	5 116,05
0430 03 2426	24x26	331	14.2	14.6	36.5	39.5	495	5 135,25
0430 03 2427	24x27	331	14.2	15	36.5	40.5	495	5 135,25
0430 03 2430	24x30	352	14.2	16.7	36.5	45	530	5 148,00
0430 03 2528	25x28	352	14.5	15.5	38	42.5	550	5 148,00
0430 03 2729	27x29	371	15	16.7	40.5	45	660	5 162,75
0430 03 2730	27x30	371	15	16.7	40.5	45	660	5 162,75
0430 03 2732	27x32	371	15	16.7	40.5	47.5	660	5 162,75
0430 03 3032	30x32	371	16.4	16.7	45	47.5	660	5 162,75
0430 03 3036	30x36	402	16.4	17.5	45	53	880	5 251,05
0430 03 3236	32x36	402	16.7	17.5	47.5	53	890	5 251,05
0430 03 3436	34x36	420	17.1	17.5	50	53	1000	5 306,85
0430 03 3641	36x41	438	17.5	19.5	53	61	1150	5 340,95
0430 03 4146	41x46	485	19.5	20.5	61	67.5	1430	5 467,20
0430 03 4650	46x50	535	20.5	22.4	67.5	73.5	1960	5 743,40

0430
Yıldız İki Ağız Anahtar Takımı (mm)
Double Ended Ring Wrench Set (mm)



KOD CODE	İÇERİK CONTENTS	g	TL/Ad.
0430 00 2108	6x7 - 8x9 - 10x11 - 12x13 - 14x15 16x17 - 18x19 - 20x22	1450	8 565,15
0430 00 2112	6x7 - 8x9 - 10x11 - 12x13 - 14x15 16x17 - 18x19 - 20x22 - 21x23 24x26 - 25x28 - 27x32	3610	12 1127,20

ÖZEL SERİLER (adet ve termin süresi isteyiniz)
SPECIAL SERIES (ask for quantity and delivery terms)

0430 03 1014	10x14	220	7.3	9	15.5	21.5	120	10	65,15
0430 03 1315	13x15	236	9	10	20	23	170	10	68,55
0430 03 2227	22x27	331	14.2	15	36.5	40.5	500	5	135,25
0430 03 3034	30x34	379	16.4	16.9	45	50	690	5	216,35

Yıldız İki Ağız Anahtar (SAE)
Double Ended Ring Wrench (SAE)

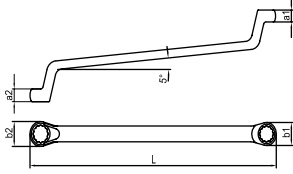
TSEK

 Krom vanadyum, Krom kaplı
 Chrom vanadium, Chrom plated

KOD CODE	inch	L mm	a1 mm	a2 mm	b1 mm	b2 mm	g	TL/ Ad.
0431 03 0608	1/4"x5/16"	176	5.6	6	10	11.5	55	10 63,20
0431 03 0809	5/16"x3/8"	190	6.4	6.8	13	14.5	75	10 65,60
0431 03 0811	5/16"x7/16"	190	6.4	7.3	13	15.5	115	10 68,75
0431 03 0911	3/8"x7/16"	206	7.3	7.6	15.5	17	115	10 72,35
0431 03 1112	7/16"x1/2"	220	8.5	9	18.5	20	135	10 78,10
0431 03 1214	1/2"x9/16"	236	9	10	20	23	145	10 82,35
0431 03 1415	9/16"x19/32"	236	9.5	10	21.5	23	165	10 82,35
0431 03 1416	9/16"x5/8"	236	9.5	10	21.5	24	165	10 83,05
0431 03 1517	19/32"x11/16"	250	10.8	11.5	25	26.5	210	10 93,15
0431 03 1920	3/4"x25/32"	271	12	12.5	27.5	29	270	10 115,60
0431 03 2122	13/16"x7/8"	311	13.1	14	32	35	400	5 139,10
0431 03 2325	15/16"x1"	331	14.2	14.6	36.5	39.5	495	5 162,15
0431 03 2631	1 1/16"x1 1/4"	371	15	16.7	40.5	48	640	5 195,35
0431 03 2833	1 1/8"x1 5/16"	371	15	16.7	40.5	48	660	5 195,35
0431 03 3033	1 3/16"x1 5/16"	371	16.4	16.7	45	48	670	5 208,35

0431
Yıldız İki Ağız Anahtar Takımı (SAE)
Double Ended Ring Wrench, Set (SAE)

TSEK



ÖZEL SERİLER (adet ve termin süresi isteyiniz)
SPECIAL SERIES (ask for quantity and delivery terms)

0431 03 1217	1/2"x11/16"	250	9	10	20	26.5	185	10 93,15
0431 03 1417	9/16"x11/16"	250	9.5	11.5	21.5	26.5	185	10 93,15
0431 03 1617	5/8"x11/16"	250	10.8	11.5	25	26.5	210	10 93,15
0431 03 1619	5/8"x3/4"	271	11.5	12.5	26.5	29	270	10 111,00
0431 03 2021	25/32"x13/16"	291	12.9	13.5	30.5	33	270	5 121,35
0431 03 1922	3/4"x7/8"	291	12.9	13.5	30.5	33	400	5 121,35
0431 03 2223	7/8"x15/16"	321	13.5	14.2	33	36.5	400	5 139,10
0431 03 2328	15/16"x1 1/8"	331	14.2	15	36.5	40.5	500	5 162,15
0431 03 2528	1"x1 1/8"	352	14.5	15.5	38	42.5	570	5 177,45
0431 03 3036	1 3/16"x1 3/8"	402	16.4	17.5	45	53	880	5 301,05
0431 03 3236	1 1/4"x1 7/16"	402	16.7	17.5	48	53	890	5 301,05
0431 03 3641	1 7/16"x1 5/8"	438	17.5	19.5	53	61	1100	5 409,25
0431 03 4146	1 11/16"x1 7/8"	485	19.5	20.5	61	67.5	1390	5 560,45
0431 03 4650	1 13/16"x2"	535	20.5	22.5	67.5	73.5	1955	5 891,85

KOD CODE	İÇERİK CONTENTS	g	TL/Ad.
0431 00 2108	1/4"x5/16" - 5/16"x3/8" 7/16"x1/2" - 9/16"x5/8" 19/32"x11/16" 3/4"x25/32" - 13/16"x7/8" 15/16"x1"	1915	8 799,95
0431 00 2112	1/4"x5/16" - 5/16"x3/8" 3/8"x7/16" - 7/16"x1/2" 9/16"x5/8" - 19/32"x11/16" 3/4"x25/32" - 13/16"x7/8" 15/16"x1" - 1 1/16"x1 1/4" 1 1/8"x1 5/16" 1 3/16"x1 5/16"	3985	12 1471,35

(★) İşaretili olan ürünler stoklarla sınırlıdır.

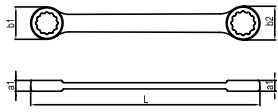
Düz Yıldız Anahtar (mm)
Flat Ring Wrench (mm)

 TS 3794
 TS ISO 10103
 DIN 837 - B

 Krom vanadyum, Krom kaplı
 Chrom vanadium, Chrom plated

KOD CODE	mm	L mm	a1 mm	b1 mm	b2 mm	g	TL/Ad.
0440 03 0607	6x7	99	4.4	9.5	11	10	47,05
0440 03 0809	8x9	113	5.2	12.5	14	25	49,15
0440 03 1011	10x11	125	6	15.5	16.5	30	54,55
0440 03 1213	12x13	140	6.8	18.5	20	45	58,85
0440 03 1415	14x15	156	7.2	21	22.5	60	68,55
0440 03 1617	16x17	170	8	24	25	80	81,25
0440 03 1819	18x19	188	8.8	26.5	27.5	105	84,90
0440 03 2022	20x22	208	9.6	29	32	135	98,60
0440 03 2123	21x23	230	10.6	30	33	170	116,80
0440 03 2426	24x26	256	10.8	35	37.5	225	118,25
0440 03 2528	25x28	280	11.8	36	40.5	270	138,15
0440 03 2732	27x32	310	12.8	38.5	45.5	355	170,65

ÖZEL SERİLER (adet ve termin süresi isteyiniz)
SPECIAL SERIES (ask for quantity and delivery terms)

0440 03 0810	8x10	120	5.6	12.5	15.5	30	10	52,65
0440 03 1013	10x13	140	6.8	18.5	20	45	10	58,85
0440 03 1315	13x15	156	7.2	20	22.5	55	10	68,55
0440 03 1317	13x17	165	7.8	20.2	25.2	85	10	81,25
0440 03 1618	16x18	188	8.8	26.5	27.5	90	10	84,90
0440 03 1719	17x19	188	8.8	26.5	27.5	105	10	84,90
0440 03 2224	22x24	230	10.8	32	35	170	10	116,80
0440 03 2427	24x27	256	10.8	35	38.5	225	10	118,25
0440 03 2729	27x29	290	12.8	38.5	42.5	285	10	157,85
0440 03 3032	30x32	310	12.8	43	45.5	360	10	170,65

0440
Düz Yıldız Anahtar Takımı (mm)
Flat Ring Wrench, Set (mm)

KOD CODE	İÇERİK CONTENTS	g	TL/Ad.
0440 00 2108	6x7 - 8x9 - 10x11 - 12x13 - 14x15 16x17 - 18x19 - 20x22	560	8 542,90
0440 00 2112	6x7 - 8x9 - 10x11 - 12x13 - 14x15 16x17 - 18x19 - 20x22 - 21x23 24x26 - 25x28 - 27x32	1540	12 1086,75

(★) İşaretili olan ürünler stoklarla sınırlıdır.

0435

Süper İzoleli Bir Ağız Yıldız Anahtar (mm) Single Ended Ring Wrench Super Insulated (mm)

± 1000 V

IEC 60900



Krom vanadyum, Krom kaplı, Kalın PVC izoleli
Chrom vanadium, Chrom plated, Triple PVC insulated

KOD CODE	mm	L mm	g	TL/Ad.
0435 03 0010	10	170	100	102,30
0435 03 0011	11	175	110	102,30
0435 03 0012	12	180	130	116,05
0435 03 0013	13	185	150	116,05
0435 03 0014	14	190	180	121,80
0435 03 0017	17	205	220	138,00
0435 03 0019	19	220	270	164,65
0435 03 0022	22	245	310	180,50
0435 03 0024	24	270	420	241,15

0530

Yarım Ay Anahtar Yıldız İki Ağız (mm) Double - Hex Starter and Block Wrench (mm)

TSEK

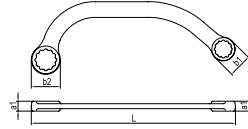

Krom vanadyum, Krom kaplı
Chrom vanadium, Chrom plated

KOD CODE	mm	L mm	a1 mm	b1 mm	b2 mm	g	TL/Ad.
0530 04 0810	8x10	120	6	12.5	15.5	30	60,65
0530 04 1011	10x11	150	7	17	20	55	71,20
0530 04 1012	10x12	150	7	17	20	55	71,20
0530 04 1113	11x13	150	7	17	20	55	71,20
0530 04 1315	13x15	185	9	21.5	26	110	84,80
0530 04 1317	13x17	185	9	21.5	26	105	84,80
0530 04 1417	14x17	185	9	21.5	26	110	84,80
0530 04 1517	15x17	185	9	21.5	26	100	84,80
0530 04 1922	19x22	230	11	29	33	195	110,35

0540

Rakor Anahtar (mm) Flare Nut Wrench (mm)

DIN 3118

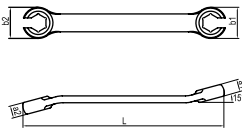

Krom vanadyum, Krom kaplı
Chrom vanadium, Chrom plated

KOD CODE	mm	L mm	a1 mm	a2 mm	b1 mm	b2 mm	g	TL/Ad.
0540 01 0810	8x10	130	7	8.5	18	20	60	92,10
0540 01 1011	10x11	150	8.5	9.3	20	22	75	95,60
0540 01 1012	10x12	150	8.5	9.3	20	22	75	95,60
0540 01 1113	11x13	170	9.3	10.8	22	25.5	105	102,40
0540 01 1214	12x14	170	9.3	10.8	22	25.5	105	102,40
0540 01 1719	17x19	210	11.8	13	30.5	33.5	185	182,75
0540 01 1922	19x22	230	12.8	14.9	33.5	39.5	235	218,80

0531

Yarım Ay Anahtar Yıldız İki Ağız (SAE) Double - Hex Starter and Block Wrench (SAE)

TSEK

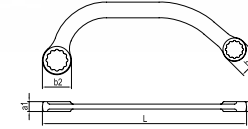

Krom vanadyum, Krom kaplı
Chrom vanadium, Chrom plated

KOD CODE	inch	L mm	a1 mm	b1 mm	b2 mm	g	TL/Ad.
0531 04 1112	7/16"x1/2"	150	7	17	20	50	87,75
0531 04 1214	1/2"x9/16"	185	9	21.5	26	110	102,05
0531 04 1416	9/16"x5/8"	185	9	21.5	26	115	105,15
0531 04 1922	3/4"x7/8"	230	11	29	33	195	132,50

ÖZEL SERİLER (adet ve termin süresi isteyiniz)
SPECIAL SERIES (ask for quantity and delivery terms)

0531 04 0809	5/16"x3/8"	120	6	12.5	15.5	30	72,60
0531 04 0911	3/8"x7/16"	150	7	17	20	50	85,45
0531 04 1417	9/16"x11/16"	185	9	21.5	26	110	101,65

(★) İşaretili olan ürünler stoklarla sınırlıdır.

Çatal Çakma Anahtar (mm)
Slugging Open Jaw Wrench (mm)

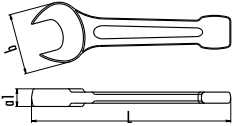
 TS 81
 DIN 133

 Krom vanadyum
 Chrom vanadium

KOD CODE	mm	L mm	a1 mm	b mm	g	TL/Ad.
0700 05 0024	24	160	14	50	280	1 122,25
0700 05 0027	27	180	15	55	385	1 151,75
0700 05 0030	30	190	16	64	525	1 186,40
0700 05 0032	32	190	16	64	530	1 209,25
0700 05 0036	36	210	18	75	755	1 234,95
0700 05 0038	38	210	18	75	760	1 282,85
0700 05 0041	41	230	18	85	920	1 307,10
0700 05 0042	42	230	18	85	930	1 354,85
0700 05 0046	46	255	20	95	1305	1 390,55
0700 05 0047	47	255	20	95	1320	1 456,10
0700 05 0050	50	275	20	105	1565	1 488,00
0700 05 0055	55	310	23	119	2305	1 654,05
0700 05 0060	60	310	23	119	2310	1 710,10
0700 05 0065	65	340	28	135	3300	1 1021,45
0700 05 0070	70	375	31	154	4555	1 1307,65
0700 05 0075	75	375	31	154	4460	1 1385,45
0700 05 0080	80	405	34	169	6115	1 1761,95
0700 05 0085	85	405	34	169	5740	1 2335,65
0700 05 0090	90	445	38	189	8040	1 2403,10
0700 05 0095	95	445	38	189	8160	1 2562,70
0700 05 0100	100	485	44	214	12355	1 3632,15
0700 05 0105	105	485	44	214	11785	1 3745,45
0700 05 0110	110	510	50	234	15000	1 4273,70
0700 05 0115	115	510	50	234	14830	1 4909,40
0700 05 0120	120	543	54	254	18865	1 5182,05

ÖZEL SERİLER (adet ve termin süresi isteyiniz)
SPECIAL SERIES (ask for quantity and delivery terms)

0700 05 0125	125	543	54	254	17250	1	-----
0700 05 0130	130	560	56	275	20000	1	-----
0700 05 0135	135	560	56	275	19700	1	-----
0700 05 0140	140	630	58.5	310	19400	1	-----
0700 05 0145	145	630	58.5	310	28000	1	-----
0700 05 0150	150	630	58.5	310	27600	1	-----

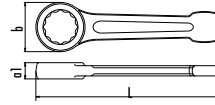
Yıldız Çakma Anahtar (mm)
Slugging Ring Wrench (mm)

 TS 3794
 DIN 7444

 Krom vanadyum
 Chrom vanadium

KOD CODE	mm	L mm	a1 mm	b mm	g	TL/Ad.
0750 05 0024	24	160	15	41.5	235	1 171,35
0750 05 0027	27	180	16	45.5	325	1 204,50
0750 05 0030	30	190	17	51	435	1 244,10
0750 05 0032	32	190	17	51	425	1 280,40
0750 05 0036	36	205	19	58	550	1 317,35
0750 05 0038	38	205	19	58	530	1 380,05
0750 05 0041	41	225	20	63	730	1 414,85
0750 05 0042	42	225	20	63	700	1 474,40
0750 05 0046	46	240	22	71	970	1 496,10
0750 05 0047	47	240	22	71	930	1 547,40
0750 05 0050	50	255	23	77	1160	1 585,75
0750 05 0055	55	272	25	88	1520	1 824,00
0750 05 0060	60	272	25	88	1460	1 894,10
0750 05 0065	65	300	28	98	2025	1 1168,85
0750 05 0070	70	330	32	108	2890	1 1338,05
0750 05 0075	75	330	32	108	2755	1 1432,15
0750 05 0080	80	360	35	126	4000	1 2034,35
0750 05 0085	85	360	35	126	3620	1 2288,85
0750 05 0090	90	390	40	140	5465	1 2815,45
0750 05 0095	95	390	40	140	5250	1 3174,75
0750 05 0100	100	420	44	148	6755	1 3670,15
0750 05 0105	105	420	44	148	6445	1 3788,50
0750 05 0110	110	450	48	166	8500	1 4049,95
0750 05 0115	115	450	48	166	8460	1 4539,75
0750 05 0120	120	490	54	178	10000	1 6239,30

ÖZEL SERİLER (adet ve termin süresi isteyiniz)
SPECIAL SERIES (ask for quantity and delivery terms)

0750 05 0125	125	490	54	178	9900	1	-----
0750 05 0130	130	518	59	196	16000	1	-----
0750 05 0135	135	518	59	196	15900	1	-----
0750 05 0140	140	518	59	196	15800	1	-----
0750 05 0145	145	580	61.8	223	22000	1	-----
0750 05 0150	150	580	61.8	223	21900	1	-----
0750 05 0155	155	580	61.8	223	21800	1	-----
0750 05 0160	160	580	61.8	223	21700	1	-----
0750 05 0165	165	648	67	262	30000	1	-----
0750 05 0170	170	648	67	262	29800	1	-----
0750 05 0180	180	648	67	262	29700	1	-----

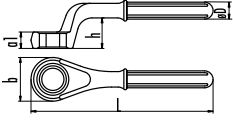
(★) İşaretili olan ürünler stoklarla sınırlıdır.

0550
Boru Uzatmalı Yıldız Anahtar (mm)
Offset Ring Wrench (mm)

Krom vanadyum, Krom kaplı
 Chrom vanadium, Chrom plated

KOD CODE	mm	L mm	a1 mm	b mm	ØD mm	h mm	g	TL/Ad.
0550 05 0024	24	180	17	37	18.5	30	400	1 179,10
0550 05 0027	27	190	18	42	18.5	33	450	1 213,40
0550 05 0030	30	200	20	46	18.5	34	520	1 254,85
0550 05 0032	32	235	21.5	49	21.2	37	700	1 292,70
0550 05 0036	36	245	23	53.5	21.2	42	830	1 331,10
0550 05 0038	38	270	25	60.5	21.2	43	965	1 382,05
0550 05 0041	41	270	25	60.5	21.2	43	950	1 432,75
0550 05 0046	46	280	26	68	24.2	45	1240	1 517,85
0550 05 0050	50	290	28	74	24.2	47	1410	1 611,40
0550 05 0055	55	300	30	79	24.2	50	1550	1 859,85
0550 05 0060	60	345	32	89	29	50.5	2390	1 933,20
0550 05 0065	65	355	34	98	29	56.5	2730	1 1010,40

ÖZEL SERİLER (adet ve termin süresi isteyiniz)
SPECIAL SERIES (ask for quantity and delivery terms)

0550 05 0022	22	180	17	37	18.5	30	400	1	-----
0550 05 0034	34	235	21.5	49	21.2	37	750	1	-----
0550 05 0070	70	365	37	104	29	55	2900	1	-----
0550 05 0075	75	375	40	109	29	57.5	3100	1	-----
0550 05 0080	80	385	43	124	29	59	3900	1	-----
0550 05 0085	85	385	43	124	29	59	3750	1	-----
0550 05 0090	90	410	46	140	29	63	5100	1	-----
0550 05 0095	95	410	46	140	29	63	4950	1	-----
0550 05 0100	100	420	46	150	29	65	4800	1	-----

0551
Döndürme Kolu Borusu
Tubular Handle

Dikişsiz Çelik Boru
 Seamless Steel Pipe

KOD CODE	mm	L mm	Ø mm	g	TL/Ad.
0551 05 0001	22 - 30	460	25	700	1 163,95
0551 05 0002	32 - 41	610	27	1220	1 222,15
0551 05 0003	46 - 55	760	32.2	1880	1 333,05
0551 05 0004	60 - 100	860	38	2975	1 449,50

0600
Kurbağacak Anahtar
Adjustable Wrench

TS 3796
 DIN 3117



İZELTAS YOUTUBE

Yedek parça sayfa 198
 Spare parts pagem 198

Krom vanadyum, Krom kaplı, PVC izoleli
 Chrom vanadium, Chrom plated, PVC insulated

KOD CODE	L mm	L inch	a mm	g	TL/Ad.
0600 01 1006	160	6"	18	120	5 164,75
0600 01 1008	208	8"	23	230	5 205,95
0600 01 1010	260	10"	28	400	5 265,45
0600 01 1012	308	12"	34	670	5 366,85
0600 01 1015	388	15"	43	1555	1 575,00

0860
Kanca Anahtar (dörtgen uçlu)
Hook Wrench

TS 3798 • DIN 1810

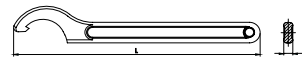

Krom vanadyum, Krom kaplı
 Chrom vanadium, Chrom plated

KOD CODE	mm	L mm	a1 mm	g	TL/Ad.
0860 05 2528	25/28	136	4	50	10 85,90
0860 05 3032	30/32	136	4	50	10 85,90
0860 05 3436	34/36	171	5	95	10 92,90
0860 05 4042	40/42	171	5	95	10 92,90
0860 05 4550	45/50	210	6	160	10 107,65
0860 05 5255	52/55	210	6	160	10 107,65
0860 05 5862	58/62	242	7	270	5 129,85
0860 05 6875	68/75	242	7	270	5 129,85
0860 05 8090	80/90	281	8	400	5 169,45
0860 05 9510	95/100	281	8	400	5 169,45

(*) İşaretli olan ürünler stoklarla sınırlıdır.

Ayarlı Montaj Anahtarı
*Adjustable Speed Wrench***R&D**
AR-GE*İZELTAŞ USTA İŞİ*
SOHBETLER**Yedek parça sayfa 198**
*Spare parts page 198***Krom vanadyum, Krom kaplı**
Chrom vanadium, Chrom plated

6 ile 22 mm arası **Altı Köşe, Torx, XZN, Ribe, Kare** gibi farklı geometriye sahip cıvataları açabilme imkanı sağlar. Anahtarı cıvata başından tam olarak çıkarmadan açma ve sıkma hareketi olanağı sağlar. Anahtar sapına özel olarak açılmış 10-13-15 mm altı köşe cıvataları açabilme imkanı sağlar

*Allows to open bolts with different geometry such as **Hexagon, Torx, XZN, Ribe, Square** in sizes from 6 to 22 mm. Enables unbolting and tightening turn without removing the wrench completely from the bolt head. Specially opened 10-13-15 mm holes on the handle, allows to open hexagon bolts.*

KOD CODE	L mm	L inch	a mm	g	TL/Ad.
0615 01 0200	200	8"	6-22	220	5 264,75



MCD ÇOK NOKTADAN TEMAS PROFİLİ / MCD MULTI CONTACT DRIVE PROFILE



İzeltas Yeni Jenerasyon Yıldız Anahtar Profili

MCD, Multi Contact Drive (çoklu temas), sıkma performansının geliştirilmesi amacıyla dizayn edilmiştir. Bilgisayar destekli titiz çalışmaların sonucunda geliştirilen MCD, klasik 12 köşe anahtardan çok daha kullanışlı, çok daha güçlüdür.

En önemli özelliği, yıldız kafadaki çoklu temas yüzeyleridir. Bu sayede civata ve somunla maksimum temas sağlanır. Böylece basınç tüm köşelere eşit olarak dağılır, temas edilen yüzeylerdeki olası hasarlar önlenir, aletin ömrü uzar.

- Yıldız kafadaki yeni profil, düzenli bir dalga şeklindedir. Güç, civatanın köşelerine değil, yan yüzeylerine etki eder (çoklu temas). Basınç daha dengeli dağıldığından temas edilen yüzeylerde ezilme meydana gelmez.
- Tolerans dışı civatalar için de uygundur.
- Civata başlarının köşelerini ezmez.
- Geniş temas alanı, anahtar ömrünü arttırır.
- Bozuk ve deforme olmuş civataları kolayca açar.

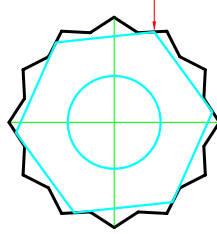

Çoklu Temas / Multi Point Contact

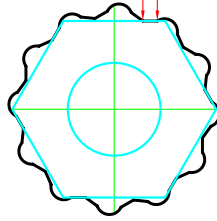

MCD Profil
MCD Profile

IZELTAS New Generation Ring Wrench Profile

MCD (Multi Contact Drive) is designed to improve the driving performance of the ring wrench. MCD, designed through computer aided drafting, transmits more torque and has longer life than conventional 12 edge ring profile.

Multi point contact is the source of effectiveness, where maximum surface area is in touch with fastener flats. Increased contact also maximizes tool's life through decreased pressure on the contact points.

- New profile of the ring wrench is formed of curves. Torque is transmitted through these curves rather than edges. As the stress is balanced between enlarged surfaces, the risk of deformation is minimized.
- It is possible to drive off-tolerance fasteners.
- Does not deform the fastener edges.
- Larger contact area increases tool's life.
- Works well with deformed fasteners.

MONTAJ ANAHTARI / SPEED WRENCH



%100 Daha Hızlı

Yeni tasarlanan montaj anahtarı, 2 kat hızlı rıçır mekanizması mantığına dayanan çalışma prensibinden alır. Kullanım sırasında, montaj anahtarını civatadan ayırmadan döndürme kolaylığı kullanım hızını arttırırken, civata köşelerine sağlam tutunan anahtar profili güvenli ve kaydırmaz kullanım sağlar.

Uzun Ömür

Bu yeni montaj anahtarı profili, civata ve somunlar ile köşelerinden değil düz yüzeyleri üzerinden temas ederek düzenli tork iletimini sağlarken, gerilimin artmasını da engelleyerek anahtar ömrünün uzamasını sağlar.

- Anahtarı civatadan ayırmadan hızlı kullanım.
- Güvenli tork iletimi ve uzun ömür.

100% Faster

New designed speed wrench takes its 100% faster rotational drive from the ratchet mechanism principle. Rotating the tool without the need for removing from the fastener provides faster usage, while enabling safer and slip-free usage with fully gripping upper and lower jaws.

Longer Tool Life

This new speed wrench profile contacts the fasteners from their flats rather than edges, which provides balanced torque transmission and decreases stress accumulation on the edges increasing the tool life considerably.

- Fast drive without removing the wrench from the fastener.
- Firm torque transmission and longer life.

AYARLI MONTAJ ANAHTARI / ADJUSTABLE SPEED WRENCH



6 ile 22 mm arası altı köşe, torx,yive ,ribe, kare gibi farklı geometriye sahip civataları açabilme imkanı sağlar. Anahtarı civata başından tam olarak çıkarmadan açma ve sıkma hareketi olanağı sağlar. Anahtar sapına özel olarak açılmış 10-13-15 mm altı köşe civataları açabilme imkanı sağlar

This tool is used for all different shapes of bolts between 6 and 22 mm. Contact between the tool and bolt is not removed to loosen and tighten the bolt. With the hexagonal holes in the handle, tool also can be used for 10-13-15mm bolts and nuts.



LOKMA VE BİJON ANAHTARLARI

SOCKETS AND RIM WRENCHES

Lokma Anahtarlar
Socket Wrenches

Lokma Takımları
Socket Wrench Sets

Kovan Anahtarlar
Tubular Socket Wrenches

Bijon Anahtarlar
Rim Wrenches

Tork Anahtarları
Torque Wrenches



Tork (Moment) ve Kuvvet / Torque (Moment) and Force

» Bilindiği üzere kuvvet bir cisme hareketini veren etkidir. Tork ise cismin bir kuvvet etkisinde döndürülmesidir. Bağlantı elemanlarını sıkma işlemlerinde genel olarak yıldız, çatal ya da lokma anahtar gibi çeşitli el aletleri kullanılır. Bu işlem fiziksel olarak işlevsel ve doğru olarak gözüke de vida, cıvata bağlantısının güvenilirliği açısından doğru bir çalışma şekli değildir. Bir vida-cıvata bağlantısının çözülmeye karşı en büyük emniyeti teorik olarak hesaplanmış olan tork değeri ile sıkılmasıdır. Bu da ancak çeşitli modern yöntemler ile sağlanabilir. Örneğin; tork anahtarı ile sıkmak, motor tahrikli sıkma işlemleri, ultrason ile sıkmak gibi. Çeşitli uygulamalar tork anahtarı kullanımının daha makul olduğunu göstermiştir.

» As you know, force is the effect which imparts movement to an object. Torque, is rotation of an object under effect of force. Various hand tools like a Philips head screwdriver, for spanner or socket wrench are used to tighten connection elements. While this process appears functional and correct, it is not an appropriate procedure for reliability of the threaded connection. The greatest safety of a threaded connection against loosening is being tightened at a certain torque level theoretically calculated beforehand. This can only be ensured with various modern methods. For example, tightening with a torque wrench, motor-driven tightening or ultrasound supported tightening. Various applications have shown that use of a torque wrench is more appropriate.



Sıkma Torku Nedir ?

» Sıkma torku, kuvvet etkisiyle döndürme kolunun uç kısmındaki anahtar ağzında oluşturulur ve birimi Nm'dir. Bu sıkma torku vida bağlantısında bir ön gerilme yaratır. Sıkma torkunun olması gerekenden düşük olması, zamanla oluşabilecek titreşimler sebebiyle vida-cıvata bağlantısında gevşeme/çözülmeye yol açabilir. Ön gerilme kuvveti fazlaca oluşan bağlantılarda ise parçalara zarar verebilir, aynı zamanda vida üzerindeki dişlerde meydana gelecek aşınmalar bağlantıyı çözülemeye kılabilir.

What is Tightening Torque ?

» Tightening torque is generated at the wrench tip at the terminus of the rotating lever under the effect of force, and its unit is Nm. This tightening torque creates a pre-tension on the threaded connection. Tightening torque being lower than what is necessary can cause the threaded connection to loosen/unravel due to vibrations that might occur over time. On the other hand, pre-tension force being over what is necessary can cause damage on the connection parts, as well as causing the threads on the connection piece to wear off or causing the connection become non-severable.

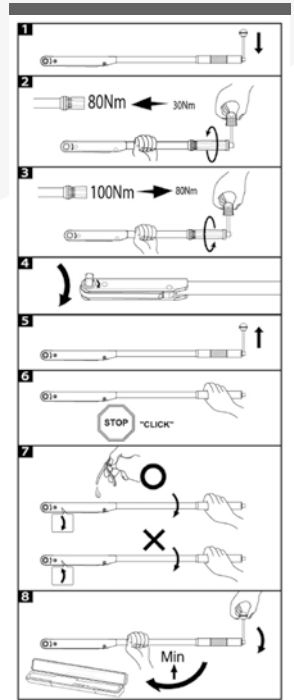

Tork Anahtarlarının Doğru Kullanımı

- » Tork anahtarı ile çalışılırken dikkat edilmesi gereken bazı hususlar bulunmaktadır. Bunlardan başlıcaları;
- Hangi tip tork anahtarı olursa olsun döndürme yönünün aksine kuvvet uygulanmaması gereklidir.
 - Cırcır anahtarlar gibi tork anahtarlarının da sökme işlemi için kullanılmaması gerekir.
 - Klik sesli modellerde klik sesi duyulduğu anda ayarlanmış tork değerine ulaşılmış demektir, daha fazla kuvvet uygulanmamalıdır.
 - Gövdesi hasar görmüş, mekanizması bozulmuş tork anahtarlarını kullanmaya devam etmeyiniz.
 - Kuvvet, tork anahtarının sap kısmından uygulanmalıdır.
 - Kullanımdan sonra nemden ve kirden korumak için her zaman kutusunda muhafaza ediniz.
 - Her kullanımdan sonra tork anahtarındaki yükü "0 Nm" konumuna getiriniz.
 - Tork anahtarlarını kendi başınıza tamir etmeye çalışmayınız.



Tork Anahtarlarının Kalibrasyonu

- » Tork anahtarlarının doğru çalışması ve bağlantıların sağlıklı sıkılabilmesi için kalibrasyon işlemi büyük önem arz etmektedir. TS EN ISO 6789-1 Standardına göre tork anahtarlarının ilk kullanımdan itibaren geçerli olmak üzere 12 aylık bir periyotta veya her 5000 kullanımlık çevrim sonunda kalibre edilmesi önerilmektedir.

Calibration Of Torque Wrenches

- » Calibration process carries great importance for torque wrenches to function correctly and be able to tighten connections in a healthy fashion. TS EN ISO 6789-1 Standard stipulates torque wrenches should be calibrated with 12 month periods or after each cycle of 5000 uses starting from the first use.

Correct Use Of Torque Wrenches

- » There are some important points that must be kept in mind when working with a torque wrench. Some of these include the following.
- No matter which type of torque wrench is used, force should not be applied at the opposite of rotating direction.
 - Torque wrenches like ratchet wrenches should not be used to loosen connections.
 - In models with click sound option, the click indicates the set torque value is achieved and further force should not be applied from then on.
 - Do not continue using torque wrenches with a damaged body or mechanism.
 - Force should be applied at the handle part of the torque wrench.
 - The tool should always be kept in its box after use to protect against moisture and dirt.
 - The load set of the torque wrench should be adjusted to "0 Nm" after each use.
 - Please do not attempt to repair torque wrenches on your own.

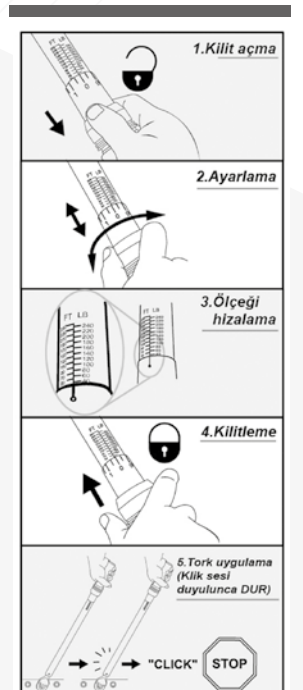

1/2" ALTI KÖŞELİ LOKMA ANAHTAR/SOCKET WRENCH 6 POINTS

Nikel üzeri krom kaplama ile korozyon direncinde üst seviye koruma
Corrosion protection with nickel over chrome plating

Yüksek dayanım için üst toleranslarda tasarım
Improved durability with upper tolerance thickness

En uygun temas yüzeyi için hassas dövülmüş altı köşe ağızlar
Precise forged hex shape for best contact area



Bilya stoplama yuvalı hassas işlenmiş kare kanal
Precise machined square adapter with ball stopper Groove

Yüksek mukavemetli alaşımli sıcak dövme çeliği
High strength alloyed forged steel

Extra sürtünme kabiliyeti için tırtıklı tasarım
Extra friction capability with knurled design



İZELTAS USTA İŞİ
SOHBETLER



İZELTAS YOUTUBE

(★) İşaretili olan ürünler stoklarla sınırlıdır.

1107

1/4" Altı Köşe Lokma Anahtar (mm) Socket Wrench 6 Points (mm)

TS ISO 2725 -1
DIN 3124

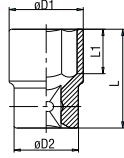

1/4"

Krom vanadyum, Krom kaplı, Polijalı
Chrom vanadium, Chrom plated, Polished

KOD CODE	mm	ø D1 mm	ø D2 mm	L mm	L1 mm	g	TL/Ad.
1107 06 0004	4	6.8	11.8	25	4	10	9,25
1107 06 0045	4.5	7.4	11.8	25	5	10	9,25
1107 06 0005	5	8	11.8	25	6	10	9,25
1107 06 0055	5.5	8.5	11.8	25	6	10	9,25
1107 06 0006	6	9.2	11.8	25	7	10	9,25
1107 06 0007	7	10.8	11.8	25	7	10	9,25
1107 06 0008	8	11.9	11.8	25	8	10	9,25
1107 06 0009	9	12.9	12.8	25	8	15	10,05
1107 06 0010	10	14.3	14.3	25	9	20	10,05
1107 06 0011	11	15.8	15.8	25	9	20	12,80
1107 06 0012	12	16.8	16.8	25	9	25	12,80
1107 06 0013	13	17.8	17.8	25	9	30	14,50

1107

1/4" Altı Köşe Derin Lokma Anahtar (mm) Deep Socket Wrench 6 Points (mm)

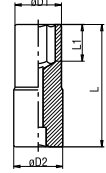

1/4"

Krom vanadyum, Krom kaplı, Polijalı
Chrom vanadium, Chrom Plated, Polished

KOD CODE	mm	ø D1 mm	ø D2 mm	L mm	L1 mm	g	TL/Ad.
1107 06 4004	4	6.8	11.8	50	6	10	18,00
1107 06 4005	5	8	11.8	50	7	20	18,00
1107 06 4055	5.5	8.7	11.8	50	9	20	18,00
1107 06 4006	6	9.2	11.8	50	9	25	20,20
1107 06 4007	7	10.8	11.8	50	15	25	20,20
1107 06 4008	8	11.8	11.8	50	15	25	20,20
1107 06 4009	9	13	13	50	15	30	21,70
1107 06 4010	10	14.5	14.5	50	15	40	21,70
1107 06 4011	11	15.8	15.8	50	21	45	23,30
1107 06 4012	12	16.8	16.8	50	21	50	23,30
1107 06 4013	13	17.8	17.8	50	21	55	23,30

1107

1/4" Derin Lokma Anahtar Set (14 parça, mm) Deep Socket Wrench Set Type (14 pcs, mm)



1/4"

KOD CODE	LOKMALAR Sockets	AVADANLIKLAR Accessories	g	TL/Ad.
1107 00 6014	4-5-5.5-6 7-8-9-10 11-12-13	1/4" Cırcır Kol Ratchet Handle	1005	14
	Altı Köşe Derin Lokma Deep Socket Wrench 6 Points	1/4" Ara Kol Extension Bar 50 mm		
		1/4" Ara Kol Extension Bar 100 mm		
				442,50

1107

1/4" Lokmalı Allen Uç
Hexagonal Bit Socket Wrench



1/4"

Krom vanadyum, Krom Kaplı
Chrom vanadium, Chrom Plated

KOD CODE	mm	L mm	g		TL/Ad.
1107 06 1125	2.5	37	13	10	15,45
1107 06 1103	3	37	13	10	15,45
1107 06 1104	4	37	15	10	15,45
1107 06 1105	5	37	15	10	15,45
1107 06 1106	6	37	15	10	15,45
1107 06 1107	7	37	16	10	18,25
1107 06 1108	8	37	17	10	18,25
1107 06 1110	10	37	19	10	22,00

1107

1/4" Lokmalı Star Delikli (Torx®) Uç
Tamper Resistant Torx Bit Socket Wrench



1/4"

Krom vanadyum, Krom Kaplı
Chrom vanadium, Chrom Plated

KOD CODE		L mm	g		TL/Ad.
1107 06 1308	TR8	37	13	10	18,55
1107 06 1309	TR9	37	13	10	18,55
1107 06 1310	TR10	37	13	10	18,55
1107 06 1315	TR15	37	14	10	18,55
1107 06 1320	TR20	37	14	10	18,55
1107 06 1325	TR25	37	14	10	18,55
1107 06 1327	TR27	37	14	10	18,55
1107 06 1330	TR30	37	15	10	18,55
1107 06 1340	TR40	37	16	10	21,75

1107

1/4" Lokmalı Star (Torx®) Uç
Torx Bit Socket Wrench



1/4"

Krom vanadyum, Krom Kaplı
Chrom vanadium, Chrom Plated

KOD CODE		L mm	g		TL/Ad.
1107 06 1208	T8	37	12	10	15,95
1107 06 1209	T9	37	12	10	15,95
1107 06 1210	T10	37	13	10	15,95
1107 06 1215	T15	37	14	10	15,95
1107 06 1220	T20	37	14	10	15,95
1107 06 1225	T25	37	14	10	15,95
1107 06 1227	T27	37	14	10	15,95
1107 06 1230	T30	37	15	10	15,95
1107 06 1240	T40	37	16	10	15,95

1107

1/4" Lokmalı Düz Uç
Slotted Bit Socket Wrench



1/4"

Krom vanadyum, Krom Kaplı
Chrom vanadium, Chrom Plated

KOD CODE		L mm	g		TL/Ad.
1107 06 1403	3	37	13	10	15,45
1107 06 1435	3.5	37	14	10	15,45
1107 06 1404	4	37	14	10	15,45
1107 06 1445	4.5	37	14	10	15,45
1107 06 1455	5.5	37	15	10	15,45
1107 06 1465	6.5	37	15	10	15,45
1107 06 1407	7	37	16	10	15,45
1107 06 1408	8	37	16	10	20,20
1107 06 1410	10	37	17	10	21,85

1107
1/4" Lokmalı Yıldız Uç
Phillips Bit Socket Wrench

1/4"
Krom vanadyum, Krom Kaplı
Chrom vanadium, Chrom Plated

KOD CODE	+	L mm	g	TL/Ad.	
1107 06 1501	Ph 1	37	14	10	15,45
1107 06 1502	Ph 2	37	14	10	15,45
1107 06 1503	Ph 3	37	15	10	15,45
1107 06 1504	Ph 4	37	16	10	15,45

1107
1/4" Bits Uçlu Lokma Set (42 Parça)
Bit Socket Wrench Set (42 Pcs)

1/4"

KOD CODE	İÇERİK CONTENTS	TL/Ad.
1107 00 1042	1/4" Lokmalı Star Torx® Uçlar Torx® Bit Socket T8-T9-T10-T15-T20-T25-T27-T30-T40	42 902,20
	1/4" Lokmalı Star Delikli Torx® Uçlar Tamper Resistant Torx® Bit Socket Wrench TR8-TR9-TR10-TR15-TR20-TR25-TR27 TR30-TR40	
	1/4" Lokmalı Allen Uçlar Hexagonal Bit Socket Wrench 2.5-3-4-5-6-7-8-10	
	1/4" Lokmalı Düz Uç Slotted Bit Socket Wrench 3-3.5-4-4.5-5.5 6.5-7-8-10	
	1/4" Lokmalı Yıldız Uç Phillips Bit Socket Wrench Ph1-Ph2-Ph3-Ph4	
	1/4" Cırcır kolu Ratchet Handle	
	1/4" Ara Kol Extension Bar 100 mm	
	1/4" Lokma Tornavida Adaptörü Spindle Handle	

Havalı aletler ile kullanmayınız / Do not use with power-tools

1507
1/4" Ara Kol
Extension Bar

 TS ISO 3316
DIN 3123

1/4"
Krom vanadyum, Krom kaplı, Polisajlı
Chrom vanadium, Chrom plated, Polished

KOD CODE	L mm	g	TL/Ad.
1507 06 0050	50	25	5 23,20
1507 06 0100	100	45	5 25,15

1507
1/4" Ara Kol Flexible
Flexible Extension

1/4"
Krom vanadyum, Krom kaplı
Chrom vanadium, Chrom plated

KOD CODE	L mm	g	TL/Ad.
1507 06 3150	150	70	5 102,60

1507
1/4" Mafsal
Universal Joint

 TS ISO 1174
DIN 3123

1/4"
Krom vanadyum, Krom kaplı, Polisajlı
Chrom vanadium, Chrom plated, Polished

KOD CODE	L mm	g	TL/Ad.
1507 06 0038	38	25	5 42,55

1507
1/4" T Kol
Sliding T - Handle

 TS ISO 3315
DIN 3122

1/4"
Krom vanadyum, Krom kaplı, Polisajlı
Chrom vanadium, Chrom plated, Polished

KOD CODE	L mm	g	TL/Ad.
1507 06 4115	115	45	5 41,75

(*) İşaretili olan ürünler stoklarla sınırlıdır.

1507**1/4" Cırcır Kolu**
Ratchet Handle

TS ISO 3315

**1/4"****Krom vanadyum, Krom kaplı, Polisajlı**
Chrom vanadium, Chrom plated, Polished

KOD CODE	L mm	g	TL/Ad.
1507 06 2140	140	140	5 166,25

1507**1/4" Mandallı Cırcır Kolu**
Ratchet With Latch

TS ISO 3315

**YENİ
NEW****1/4"****Krom vanadyum, Krom kaplı, Polisajlı**
Chrom vanadium, Chrom plated, Polished

KOD CODE	L mm	g	TL/Ad.
1507 06 6140	140	140	5 237,90

1507**1/4" Mafsallı Cırcır Kolu (72 Diş)**
*Swivel Head Ratchet (72 Teeth)***YENİ
NEW****1/4"****Krom vanadyum, Krom kaplı, Polisajlı**
Chrom vanadium, Chrom plated, Polished

KOD CODE	L mm	g	TL/Ad.
1507 06 2150	150	130	5 551,40

1507**1/4" Lokma/Bits Tutuculu Cırcır Kolu (72 Diş)**
*Socket/Bit Holder mini Ratchet (72 Teeth)***YENİ
NEW****1/4"****Krom vanadyum, Krom kaplı, Polisajlı**
Chrom vanadium, Chrom plated, Polished

KOD CODE	L mm	g	TL/Ad.
1507 06 2110	110	100	5 346,00

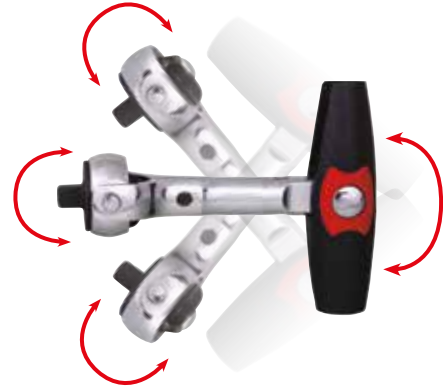
1507**1/4" Mafsallı T Kol Cırcır (72 Diş)**
*Swivel Head, T Handle Ratchet (72 Teeth)***YENİ
NEW****1/4"****Krom vanadyum, Krom kaplı, Polisajlı**
Chrom vanadium, Chrom plated, Polished

KOD CODE	L mm	g	TL/Ad.
1507 06 7115	115	110	5 529,80

1507

1/4" Lokma Adaptörü
Adapter

TS ISO 3316
DIN 3123



1/4"

Krom vanadyum, Krom kaplı, Polisajlı
Chrom vanadium, Chrom plated, Polished

KOD CODE	inch	g		TL/Ad.
1507 06 0004	1/4"Fx3/8"M	20	5	21,45

1507

1/4" Derin Lokma Torna Vida Adaptörü
Spindle Handle

TS ISO 3315
DIN 3122



1/4"

Krom vanadyum, Krom kaplı, Polisajlı, Selüloz Asetat Saplı
Chrom vanadium, Chrom plated, Polished, Cellulose Acetate Handle

KOD CODE	L mm	L1 mm	g		TL/Ad.
1507 06 4080	150	65	100	10	49,35

1107

1/4" Bits Tutucu Lokma (Mıknatıslı)
Bit Holder Socket



1/4"

Krom vanadyum
Chrom vanadium

KOD CODE	Inch	g		TL/Ad.
1107 06 5010	1/4" F - 1/4" F	15	5	34,35

1107

1/4" Altı Köşe Lokma Anahtar Takımı (15 parça, mm)
Socket Wrench Set 6 Points (15 pcs, mm)



1/4"

KOD CODE	LOKMALAR Sockets	AVADANLIKLAR Accessories	g		TL/Ad.
1107 00 6015	4 - 5 - 6 7 - 8 - 9 - 10 11 - 12 - 13 Altı Köşe Six Points	1/4" Cırcır kolu Ratchet Handle 1/4" Mafsalsal Universal Joint 1/4" T Kol Sliding T Handle 1/4" Ara Kol Extension Bar 50 mm 1/4" Ara Kol Extension Bar 100 mm	960	15	405,35



Havali aletler ile kullanmayınız / Do not use with power-tools

1110

3/8" Altı Köşe Lokma Anahtar (mm)
Socket Wrench 6 Points (mm)

TS ISO 2725 - 1
DIN 3124

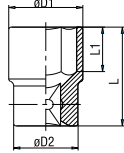

3/8"

Krom vanadyum, Krom kaplı, Polisajlı
Chrom vanadium, Chrom plated, Polished

KOD CODE	mm	σ D1 mm	σ D2 mm	L mm	L1 mm	g	TL/Ad.	
1110 06 0006	6	9.8	17.8	27	9	25	10	23,95
1110 06 0007	7	10.8	17.8	27	9	25	10	23,95
1110 06 0008	8	12	17.8	27	9	25	10	23,95
1110 06 0009	9	13.2	17.8	27	9	25	10	23,95
1110 06 0010	10	14.5	17.8	27	9	25	10	23,95
1110 06 0011	11	15.8	17.8	27	9	30	10	23,95
1110 06 0012	12	16.8	17.8	27	9	30	10	23,95
1110 06 0013	13	17.8	16.8	27	9	30	10	25,60
1110 06 0014	14	19.6	17.5	29	11	35	10	25,60
1110 06 0015	15	20.8	18	29	11	45	10	25,60
1110 06 0016	16	21.8	19	29	11	45	10	26,75
1110 06 0017	17	23.4	20	29	11	55	10	26,75
1110 06 0018	18	24.7	21	29	13	60	10	27,80
1110 06 0019	19	25.8	22	29	13	65	10	32,00
1110 06 0021	21	27.8	24	32	13	80	10	36,20
1110 06 0022	22	29.7	26	32	15	85	10	38,65
1110 06 0023	23	29.7	26	32	15	90	10	38,65

1110

3/8" Buji Lokma Anahtar (Lastikli)
Spark Plug Socket with Rubber

TS ISO 2725 - 1



3/8"

Krom vanadyum, Krom kaplı, Polisajlı
Chrom vanadium, Chrom plated, Polished

KOD CODE	mm	L mm	g	TL/Ad.	
1110 06 9208	21	70	145	10	50,35

1510

3/8" Cırcır Kolu
Ratchet Handle

TS ISO 3315
DIN 3122



3/8"

Krom vanadyum, Krom kaplı, Polisajlı
Chrom vanadium, Chrom plated, Polished

KOD CODE	L mm	g	TL/Ad.	
1510 06 0200	200	295	5	281,50

1510

3/8" Ara Kol
Extension Bar

TS ISO 3316
DIN 3123



3/8"

Krom vanadyum, Krom kaplı, Polisajlı
Chrom vanadium, Chrom plated, Polished

KOD CODE	L mm	g	TL/Ad.	
1510 06 0075	75	75	5	42,75
1510 06 0150	150	145	5	64,65

1510

3/8" Mafsal
Universal Joint

TS ISO 3316
DIN 3123



3/8"

Krom vanadyum, Krom kaplı, Polisajlı
Chrom vanadium, Chrom plated, Polished

KOD CODE	L mm	g	TL/Ad.	
1510 06 0056	56.5	60	5	69,40

1510

3/8" T Kol
Sliding T - Handle

TS ISO 3315
DIN 3122



3/8"

Krom vanadyum, Krom kaplı, Polisajlı
Chrom vanadium, Chrom plated, Polished

KOD CODE	L mm	g	TL/Ad.
1510 06 1200	200	180	5 99,75

1510

3/8" Lokma Adaptörü
Adapter

TS ISO 3316
DIN 3123



3/8"

Krom vanadyum, Krom kaplı, Polisajlı
Chrom vanadium, Chrom plated, Polished

KOD CODE	inch	g	TL/Ad.
1510 06 0007	3/8"Fx1/2"M	45	5 47,60

1110

3/8" Altı Köşe Lokma Anahtar Takımı (19 parça, mm)
6 Points Socket Wrench Set (19 Pcs, mm)



3/8"

KOD CODE	LOKMA LAR Sockets	AVADANLIKLAR Accessories	g	TL/Ad.
		3/8" Cırcır Kolu Ratchet Handle		
		3/8" Mafsal Universal Joint		
	6 - 7 - 8 - 9 10 - 11 - 12 13 - 14 - 17 19 - 21 - 23			
	Altı Köşe Six Points			
1110 00 6019	20.8	3/8" T Kol Sliding T Handle	1089	19 960,85
	Buji Lokma Lastikli Altı Köşe Spark Plug Socket With Rubber			
		3/8" Ara Kol Extension Bar 75 mm		
		3/8" Ara Kol Extension Bar 150 mm		

Havali aletler ile kullanmayınız / Do not use with power-tools

1/2" Lokma Anahtar Sehпасı (145 Parça)
Display Frame for Sockets (145 Pcs)

1/2"

KOD CODE	İÇERİK CONTENTS	g		TL/Ad.
	Dolu/Full			
	10-11-12 13-14-15 16-17-18-19 10 adet /10 Pcs			
1113 00 6145		18.236	1	7182,10
	21-22-23 24-26-27 28-30-32 5 Adet / 5 Pcs			

1/2" Altı Köşe Lokma Anahtar (mm)
Socket Wrench 6 Points (mm)

 TS ISO 2725 -1
 DIN 3124

1/2"

 Krom vanadyum, Krom kaplı
Chrom vanadium, Chrom plated

KOD CODE	mm	ø D1 mm	ø D2 mm	L mm	L1 mm	g		TL/ Ad.
1113 06 1008	8	14	22	38	7	55	10	30,85
1113 06 1009	9	14.1	22	38	7	55	10	30,85
1113 06 1010	10	15.4	22	38	8	55	10	38,30
1113 06 1011	11	16.6	22	38	8	60	10	38,30
1113 06 1012	12	17.8	22	38	9	60	10	38,30
1113 06 1013	13	19	22	38	10	65	10	41,15
1113 06 1014	14	20.4	22	38	11	65	10	41,15
1113 06 1015	15	21.6	22	38	11	65	10	41,15
1113 06 1016	16	22.9	22	38	11	70	10	43,10
1113 06 1017	17	24	22	38	12	70	10	43,10
1113 06 1018	18	25.4	23	38	13	75	10	43,10
1113 06 1019	19	26.6	23	38	13	75	10	45,05
1113 06 1020	20	28	24	38	13	80	10	45,05
1113 06 1021	21	29.2	24	38	13	85	5	45,05
1113 06 1022	22	30.4	26	38	15	95	5	45,05
1113 06 1023	23	31.2	28	38	15	100	5	46,95
1113 06 1024	24	32.9	28	38	17	115	5	46,95
1113 06 1025	25	33.2	29	42	17	125	5	46,95
1113 06 1026	26	34	30	42	17	135	5	46,95
1113 06 1027	27	36.6	30	42	19	140	5	53,85
1113 06 1028	28	37.5	30	42	20	160	5	53,85
1113 06 1029	29	39.5	32	42	21	170	5	56,65
1113 06 1030	30	40	32	44	21	180	5	56,65
1113 06 1032	32	43	34	44	23	190	5	58,95



1114

1/2" On İki Köşe Lokma Anahtar (mm) Socket Wrench 12 Points (mm)

TS ISO 2725 - 1
DIN 3124



1/2"

Krom vanadyum, Krom kaplı
Chrom vanadium, Chrom plated

KOD CODE	mm	ø D1 mm	ø D2 mm	L mm	L1 mm	g	TL/Ad.
1114 06 1010	10	15	23.3	38	8	60	38,40
1114 06 1011	11	16.4	23.3	38	8	60	38,40
1114 06 1012	12	17.8	23.3	38	9	60	38,40
1114 06 1013	13	19	23.3	38	10	60	41,55
1114 06 1014	14	20.4	23.3	38	11	60	41,55
1114 06 1015	15	21.6	23.3	38	11	65	41,55
1114 06 1016	16	22.9	24	38	11	70	43,35
1114 06 1017	17	24	22.5	38	12	70	43,35
1114 06 1018	18	25.2	23	38	13	70	43,35
1114 06 1019	19	26.8	23	38	13	75	45,40
1114 06 1020	20	28	23	38	13	80	45,40
1114 06 1021	21	29.2	23	38	13	80	45,40
1114 06 1022	22	30.2	24	40	15	95	45,40
1114 06 1023	23	31.4	25	40	15	100	47,30
1114 06 1024	24	32.6	26	42	17	105	47,30
1114 06 1026	26	35.3	28	42	17	135	53,20
1114 06 1027	27	36.6	28	42	19	135	60,80
1114 06 1028	28	37.8	30	42	20	155	60,80
1114 06 1030	30	40	30	44	21	165	63,85
1114 06 1032	32	42.5	30	44	23	180	66,95



Havali aletler ile kullanmayınız / Do not use with power-tools

1413

1/2" On İki Köşe Lokma Anahtar (SAE) Socket Wrench 12 Points (SAE)



1/2"

Krom vanadyum, Krom kaplı
Chrom vanadium, Chrom plated

KOD CODE	inch	ø D1 mm	ø D2 mm	L mm	L1 mm	g	TL/Ad.
1413 06 1008	5/16"	13.2	21.8	37	6	45	45,00
1413 06 1095	3/8"	15	21.8	37	8	50	45,00
1413 06 1010	7/16"	16.4	23.3	37	9	60	46,55
1413 06 1011	15/32"	18	23.3	37	9	60	46,55
1413 06 1012	1/2"	19	23.3	37	9	60	48,40
1413 06 1013	9/16"	20.4	23.3	37	11	60	50,15
1413 06 1014	19/32"	21.6	23.3	37	11	65	50,15
1413 06 1015	5/8"	23.1	22	38	11	70	50,65
1413 06 1016	11/16"	24.5	22.5	38	11	70	52,35
1413 06 1017	3/4"	26.8	23	38	13	75	52,90
1413 06 1020	25/32"	28	23	38	13	75	54,75
1413 06 1021	13/16"	28.6	23	38	13	80	54,75
1413 06 1022	7/8"	30.2	24	40	15	90	54,75
1413 06 1024	15/16"	32.6	26	42	17	115	57,10
1413 06 1025	1"	35	28	42	17	130	57,10
1413 06 1027	1 1/16"	36.6	28	42	19	135	74,85
1413 06 1029	1 1/8"	38.8	30	42	19	170	74,85
1413 06 1030	1 3/16"	40	29.5	44	20	170	74,85
1413 06 1032	1 1/4"	42.5	30	44	22	185	74,85

1113

1/2" Buji Lokma Anahtar (Lastikli) Spark Plug Socket with Rubber



1/2"

Krom vanadyum, Krom kaplı, Polisajlı
Chrom vanadium, Chrom plated, Polished

KOD CODE	mm	L mm	g	TL/Ad.
1113 06 9160	16	70	80	54,35
1113 06 9208	21	70	155	70,10

(★) İşaretili olan ürünler stoklarla sınırlıdır.

1108

1/2" Altı Köşe Derin Lokma Anahtar (mm)
Deep Socket Wrench 6 Points (mm)

TS ISO 2725 - 1
DIN 3124



1/2"

Krom vanadyum, Krom kaplı
Chrom vanadium, Chrom plated

KOD CODE	mm	ØD1 mm	ØD2 mm	L mm	L1 mm	g	TL/Ad.	
1108 06 0010	10	15,2	22	75	6	110	10	71,85
1108 06 0011	11	16,7	24	75	7	110	10	71,85
1108 06 0012	12	18	24	75	8	110	10	71,85
1108 06 0013	13	19	24	75	8	120	10	77,00
1108 06 0014	14	20,5	24	75	10	120	10	77,00
1108 06 0015	15	21,7	24	75	10	140	10	77,00
1108 06 0016	16	22	25,5	75	10	140	10	80,65
1108 06 0017	17	24	25,5	75	10	140	10	80,65
1108 06 0018	18	25,5	25,5	75	12	150	10	80,65
1108 06 0019	19	26	26,7	75	12	150	10	84,30

1108

1/2" Altı Köşe Derin Lokma Anahtar Takımı (10 parça mm)
Deep Socket Set (10 pcs. mm)



1/2"

KOD CODE	İÇERİK CONTENTS	g	TL/Ad.	
1108 00 6010	10-11-12-13-14-15 16-17-18-19	1290	10	772,80

1113

1/2" Star (Torx®) Lokma Anahtar
Star Torx® Socket Wrench



1/2"

Krom vanadyum, Krom kaplı
Chrom vanadium, Chrom plated

KOD CODE	Star	Ø D1 mm	Ø D2 mm	L mm	L1 mm	g	TL/Ad.	
1113 06 0210	E10	13.2	23.8	37	7.5	60	10	36,80
1113 06 0212	E12	15	23.8	37	9	65	10	36,80
1113 06 0214	E14	16.4	23.8	37	10	65	10	36,80
1113 06 0216	E16	18.8	23.8	37	11	70	10	36,80
1113 06 0218	E18	20.5	23.8	39	12.5	75	10	36,80
1113 06 0220	E20	23	23.8	39	14	75	10	41,45

1113

1/2" Star (Torx®) Lokma Anahtar Takımı (7 Parça)
Star Torx® Socket Wrench Set (7 Pcs)



1/2"

KOD CODE	İÇERİK CONTENTS	g	TL/Ad.	
1113 00 6007	Star Lokma / Star Socket E10 - E12 - E14 - E16 - E18 - E20 125 mm Ara Kol / Extension Bar	1075	7	304,65

1113
1/2" Lokmalı Allen Uç
Hexagonal Bit Socket Wrench

1/2"

 Krom vanadyum, Krom kaplı
Chrom vanadium, Chrom plated

KOD CODE	mm	L mm	g	TL/Ad.
1113 06 1105	5	60	70	48,20
1113 06 1106	6	60	70	48,20
1113 06 1107	7	60	75	48,20
1113 06 1108	8	60	75	48,20
1113 06 1110	10	60	85	54,95
1113 06 1112	12	60	100	54,95
1113 06 1114	14	60	115	54,95
1113 06 4105	5	100	90	56,90
1113 06 4106	6	100	90	56,90
1113 06 4107	7	100	90	56,90
1113 06 4108	8	100	95	56,90
1113 06 4110	10	100	105	65,85
1113 06 4112	12	100	145	65,85
1113 06 4114	14	100	155	79,35
1113 06 4117	17	100	200	106,00

1113
1/2" Lokmalı Star (Torx®) Uç
Star (Torx®) Bit Socket Wrench

1/2"

 Krom vanadyum, Krom kaplı
Chrom vanadium, Chrom plated

KOD CODE	☆	L mm	g	TL/Ad.
1113 06 1220	T20	60	70	59,40
1113 06 1225	T25	60	70	59,40
1113 06 1227	T27	60	70	59,40
1113 06 1230	T30	60	70	59,40
1113 06 1240	T40	60	70	59,40
1113 06 1245	T45	60	70	59,40
1113 06 1250	T50	60	75	59,40
1113 06 1255	T55	60	80	59,40
1113 06 1260	T60	60	100	63,20
1113 06 4220	T20	100	78	67,15
1113 06 4225	T25	100	79	67,15
1113 06 4227	T27	100	80	67,15
1113 06 4230	T30	100	80	67,15
1113 06 4240	T40	100	80	67,15
1113 06 4245	T45	100	82	67,15
1113 06 4250	T50	100	82	67,15
1113 06 4255	T55	100	100	67,15
1113 06 4260	T60	100	134	69,65

1113
1/2" Lokmalı Allen Uç Takımı (60 mm, 7 Parça)
Hexagonal Bits Socket Wrench Set (60 mm, 7 Pcs)

1/2"

KOD CODE	İÇERİK CONTENTS	g	TL/Ad.
1113 00 1107	Allen Uçlar 60mm Hex Bit Socket 5-6-7-8-10-12-14	1040	357,65

1113
1/2" Lokmalı Torx® Uç Takımı (60 mm, 9 parça)
Torx® Bits Socket Wrench Set (60 mm, 9 Pcs)

1/2"

KOD CODE	İÇERİK CONTENTS	g	TL/Ad.
1113 00 6009	Torx® Uçlar 60mm Star Socket T20 - T25 - T27 - T30 - T40 - T45 T50 - T55 - T60	1125	538,40

1113

1/2" Lokmalı Allen Uç ve Star (Torx)® Uç Takımı (17 Parça) Hex Bit Sockets - Torx Bit Sockets Set (17 Pcs)



1/2"

KOD CODE	İÇERİK CONTENTS	g	TL/Ad.
1113 00 6017	<p>T Koli (1/2") Sliding T Handle</p> <p>5 - 6 - 7 - 8 - 10 - 12 - 14</p> <p>Lokmalı Allen Uç 60mm Hex Bit Socket</p> <p>T20 - T25 - T27 T30 - T40</p> <p>Lokmalı Star (Torx) Uç 60mm Torx Bit Socket</p>	17	1069,25



Havali aletler ile kullanmayınız / Do not use with power-tools

1114

1/2" On İki Köşe Lokmalı Bits Uç Yivli (XZN) Hex Bit Socket 12 Points (XZN)



1/2"



Krom vanadyum, Krom kaplı
Chrom vanadium, Chrom plated

KOD CODE	TL/Ad.	L mm	g	TL/Ad.	
1114 06 4005	M5	60	60	10	43,70
1114 06 4006	M6	60	62	10	43,70
1114 06 4008	M8	60	62	10	43,70
1114 06 4010	M10	60	78	10	43,70
1114 06 4012	M12	60	84	10	51,75
1114 06 4106	M6	80	69	10	55,15
1114 06 4108	M8	80	70	10	55,15
1114 06 4110	M10	80	84	10	60,75
1114 06 4112	M12	80	103	10	62,80
1114 06 4114	M14	80	133	10	67,20
1114 06 4208	M8	140	96	10	61,85
1114 06 4210	M10	140	125	10	75,80
1114 06 4212	M12	140	161	10	85,45
1114 06 4214	M14	140	210	10	95,90
1114 06 4216	M16	140	281	10	139,00

1114

1/2" Lokmalı (Ribe) Bits Uç Socket Wrench 6 Points



1/2"



Krom vanadyum, Krom kaplı
Chrom vanadium, Chrom plated

KOD CODE	TL/Ad.	L mm	g	TL/Ad.	
1114 06 5004	4	100	75	10	60,10
1114 06 5005	5	100	76	10	60,10
1114 06 5006	6	100	76	10	60,10
1114 06 5007	7	100	77	10	60,10
1114 06 5008	8	100	78	10	60,10
1114 06 5009	9	100	85	10	60,60
1114 06 5010	10	100	96	10	60,60
1114 06 5011	10.5	100	96	10	62,00
1114 06 5012	12	100	121	10	77,15
1114 06 5013	13	100	148	10	84,75
1114 06 5014	14	100	150	10	84,75
1114 06 5016	16	100	198	10	114,60

(★) İşaretili olan ürünler stoklarla sınırlıdır.

1513

1/2" Cırcır Kolu (32 Diş)
Ratchet Handle

TS ISO 3315
DIN3122

1/2"

Krom vanadyum, Krom kaplı
Chrom vanadium, Chrom plated

KOD CODE	L mm	g	TL/Ad.
1513 06 0032	250	580	5 313,35

1513

1/2" Ara Kol
Extension Bar

TS ISO 3316
DIN 3123

1/2"

Krom vanadyum, Krom kaplı
Chrom vanadium, Chrom plated

KOD CODE	L mm	g	TL/Ad.
1513 06 4075	75	140	5 70,85
1513 06 4125	125	215	5 79,20
1513 06 4250	250	420	5 120,60

1513

1/2" T Kol Adaptörü
Adapter

1/2"

Krom vanadyum, Krom kaplı
Chrom vanadium, Chrom plated

KOD CODE	inch	g	TL/Ad.
1513 06 5250	3/8" Fx1/2" M	90	5 73,95

1513

1/2" T Kol
Sliding T - Handle

TS ISO 3315
DIN 3122

1/2"

Krom vanadyum, Krom kaplı
Chrom vanadium, Chrom plated

KOD CODE	L mm	g	TL/Ad.
1513 06 2250	250	355	5 173,20

1513

1/2" Mafsal
Universal Joint

TS ISO 3316
DIN 3123

1/2"

Krom vanadyum, Krom kaplı
Chrom vanadium, Chrom plated

KOD CODE	L mm	g	TL/Ad.
1513 06 4070	70	140	5 100,65

1513

1/2" Lokma Adaptörü
Adapter

TS ISO 3316
DIN 3123

1/2"

Krom vanadyum, Krom kaplı
Chrom vanadium, Chrom plated

KOD CODE	inch	g	TL/Ad.
1513 06 0002	1/2" Fx3/8" M	55	5 36,90
1513 06 0003	1/2" Fx3/4" M	115	5 58,05

1113

1/2" Bits Tutucu Lokma
Bit Holder Scket

1/2"

Krom vanadyum, Krom kaplı
Chrom vanadium, Chrom plated

KOD CODE	Inch	g	TL/Ad.
1113 06 5010	1/2" F - 1/4" F	50	5 42,25

Havali aletler ile kullanmayınız / Do not use with power-tools

1/4" - 1/2" Altı Köşe Lokma Anahtar Takımı (35 Parça)
Socket Wrench Set 6 Point 1/4" - 1/2" (35 Pcs)



KOD CODE	LOKMALAR Sockets	AVADANLIKLAR Accessories	g		TL/Ad.
1113 00 1038	4 - 5 - 6 7 - 8 - 9 - 10 11 - 12 - 13 Altı Köşe Six Points	1/4" Cırcır kolu Ratchet Handle 1/4" Mafsal Universal Joint 1/4" T Kol Sliding T Handle 1/4" Ara Kol Extension Bar 50 mm 1/4" Ara Kol Extension Bar 100 mm	4000	35	1703,30
	10 - 11 - 12 13 - 14 - 15 16 - 17 - 18 19 - 21 - 22 24 - 27 - 30 32 Altı Köşe Six Points	1/2" Cırcır Kolu Ratchet Handle 1/2" T Kol Adaptör Sliding T Handle Adapter 1/2" Ara Kol Extension Bar 75 mm 1/2" Ara Kol Extension Bar 250 mm			

1113

1/2" Altı Köşe Lokma Anahtar Takımı (17 Parça, mm)
Socket Wrench Set 6 Points (17 pcs, mm)



1/2"

KOD CODE	LOKMALAR Sockets	AVADANLIKLAR Accessories	g	TL/Ad.
1113 00 2017	10 - 11 - 12 13 - 14 - 15 17 - 19 - 22 24 - 27 - 30 32	1/2" Cırcır Kolu Ratchet Handle 1/2" T Kol Adaptör Sliding T Handle Adapter 1/2" Mafsal Universal Joint 1/2" Ara Kol Extension Bar 250 mm	2880	17 1196,50

1113

1/2" Altı Köşe Lokma Anahtar Takımı (24 Parça, mm)
Socket Wrench Set 6 Points (24 pcs, mm)



1/2"

KOD CODE	LOKMALAR Sockets	AVADANLIKLAR Accessories	g	TL/Ad.
1113 00 2024	10 - 11 - 12 13 - 14 - 15 16 - 17 - 18 19 - 21 - 22 23 - 24 - 26 27 - 28 - 30 32	1/2" Cırcır Kolu Ratchet Handle 1/2" Mafsal Universal Joint 1/2" T Kol Adaptör Sliding T Handle Adapter 1/2" Ara Kol Extension Bar 125 mm 1/2" Ara Kol Extension Bar 250 mm	3650	24 1554,70

1114

1/2" On İki Köşe Lokma Anahtar Takımı (24 Parça, mm)
Socket Wrench Set 12 Points (24 pcs, mm)



1/2"

KOD CODE	LOKMALAR Sockets	AVADANLIKLAR Accessories	g	TL/Ad.
1114 00 6024	10 - 11 - 12 13 - 14 - 15 16 - 17 - 18 19 - 21 - 22 23 - 24 - 26 27 - 28 - 30 32	1/2" Cırcır Kolu Ratchet Handle 1/2" Mafsal Universal Joint 1/2" T Kol Adaptör Sliding T Handle Adapter 1/2" Ara Kol Extension Bar 125 mm 1/2" Ara Kol Extension Bar 250 mm	4150	24 1594,05

1413

1/2" On İki Köşe Lokma Anahtar Takımı (24 parça, SAE)
Socket Wrench Set 12 Points (24 pcs, SAE)



1/2"

KOD CODE	LOKMALAR Sockets	AVADANLIKLAR Accessories	g	TL/Ad.
1413 00 6024	5/16" - 3/8" 7/16" - 15/32" 1/2" - 9/16" 19/32" - 5/8" 11/16" - 3/4" 25/32" - 13/16" 7/8" - 15/16" 1" - 1 1/16" 1 1/8" - 1 3/16" 1 1/4"	1/2" Cırcır Kolu Ratchet Handle 1/2" Mafsal Universal Joint 1/2" T Kol Adaptör Sliding T Handle Adapter 1/2" Ara Kol Extension Bar 125 mm 1/2" Ara Kol Extension Bar 250 mm	4150	24 1753,30



1119
3/4" Altı Köşe Lokma Anahtar (mm)
Socket Wrench 6 Points (mm)

 TS ISO 2725 - 1
 DIN 3124

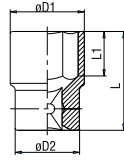
3/4"

 Krom vanadyum, Krom kaplı
Chrom vanadium, Chrom plated

KOD CODE	mm	ø D1 mm	ø D2 mm	L mm	L1 mm	g	TL/Ad.
1119 06 1022	22	33	36	52	16	225	5 95,55
1119 06 1024	24	35	36	52	16	230	5 95,55
1119 06 1027	27	38	36	52	19	235	5 98,70
1119 06 1030	30	42	38	54	21	300	5 106,40
1119 06 1032	32	44	38	56	23	320	5 110,65
1119 06 1034	34	47	42	58	24	400	5 146,00
1119 06 1036	36	50	42	58	25	440	5 146,00
1119 06 1038	38	52	45	60	27	500	5 146,00
1119 06 1041	41	56	45	64	29	580	1 214,60
1119 06 1046	46	62	48	68	33	730	1 228,50
1119 06 1050	50	68	48	72	34	885	1 274,40
1119 06 1055	55	74	48	76	37	1070	1 349,40
1119 06 1060	60	80	48	78	38	1170	1 417,25

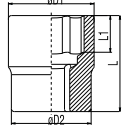
1419
3/4" On İki Köşe Lokma Anahtar (SAE)
Socket Wrench 12 Points (SAE)

3/4"

 Krom vanadyum, Krom kaplı
Chrom vanadium, Chrom plated

KOD CODE	inch	øD1 mm	øD2 mm	L mm	L1 mm	g	TL/Ad.
1419 06 1022	7/8"	33	36	52	16	220	5 105,95
1419 06 1024	15/16"	35	36	52	16	220	5 105,95
1419 06 1025	1"	35	36	52	17	220	5 106,40
1419 06 1027	1 1/16"	38	36	52	19	225	5 109,15
1419 06 1028	1 1/8"	40	38	52	19	225	5 109,15
1419 06 1032	1 1/4"	44	38	56	23	315	5 122,50
1419 06 1033	1 5/16"	46	38	56	23	355	5 152,45
1419 06 1035	1 3/8"	48	42	58	25	400	5 152,45
1419 06 1036	1 7/16"	50	42	58	25	425	5 159,70
1419 06 1038	1 1/2"	52	45	60	27	475	5 159,70
1419 06 1041	1 5/8"	56	45	64	29	555	1 236,70
1419 06 1044	1 3/4"	60	47	66	31	660	1 249,80
1419 06 1046	1 13/16"	62	47	68	34	685	1 251,40
1419 06 1047	1 7/8"	64	48	70	34	730	1 301,60
1419 06 1050	2"	68	48	72	34	805	1 303,70

1120
3/4" On İki Köşe Lokma Anahtar (mm)
Socket Wrench 12 Points (mm)

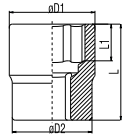
 TS ISO 2725 - 1
 DIN 3124

3/4"

 Krom vanadyum, Krom kaplı
Chrom vanadium, Chrom plated

KOD CODE	mm	øD1 mm	øD2 mm	L mm	L1 mm	g	TL/Ad.
1120 06 1022	22	33	36	52	16	220	5 101,00
1120 06 1024	24	35	36	52	17	225	5 101,00
1120 06 1027	27	38	36	52	19	225	5 104,15
1120 06 1030	30	42	38	54	21	285	5 112,20
1120 06 1032	32	44	38	56	23	310	5 117,40
1120 06 1034	34	47	42	57	24	385	5 154,45
1120 06 1036	36	50	42	58	25	435	5 154,45
1120 06 1041	41	56	45	64	29	560	1 227,95
1120 06 1046	46	62	47	68	34	685	1 242,35
1120 06 1050	50	68	48	72	34	840	1 290,05

1519
3/4" Cırcır Kolu
Ratchet Handle

 TS ISO 3315
 DIN 3122

3/4"

 Krom vanadyum, Krom kaplı
Chrom vanadium, Chrom plated

KOD CODE	L mm	g	TL/Ad.
1519 06 4510	510	2230	5 929,30

1519
3/4" Ara Kol
Extension Bar

 TS ISO 3316
 DIN 3123

3/4"

 Krom vanadyum, Krom kaplı
Chrom vanadium, Chrom plated

KOD CODE	L mm	g	TL/Ad.
1519 06 4200	200	730	5 245,00
1519 06 4400	400	1370	5 443,75

Havalı aletler ile kullanmayınız / Do not use with power-tools

1519

3/4" T Kol
Sliding T - Handle

TS ISO 3315
DIN 3122



3/4"

Krom vanadyum, Krom kaplı
Chrom vanadium, Chrom plated

KOD CODE	L mm	g	□	TL/Ad.
1519 06 4500	500	1485	5	493,85

1519

3/4" Lokma Adaptörü
Adapter

TS ISO 3316
DIN 3123



3/4"

Krom vanadyum, Krom kaplı
Chrom vanadium, Chrom plated

KOD CODE	inch	g	□	TL/Ad.
1519 06 0008	3/4"Fx1/2"M	140	5	97,65
1519 06 0001	3/4"Fx1"M	300	5	132,00

1119

3/4" Altı Köşe Lokma Anahtar Takımı (14 parça, mm)
Socket Wrench Set 6 Points (14 pcs, mm)



3/4"

KOD CODE	LOKMALAR Sockets	AVADANLIKLAR Accessories	g	□	TL/Ad.
1119 00 6114	22 - 24 - 27 30 - 32 - 34 36 - 41 - 46 50	3/4" Cırcır Kolu Ratchet Handle	10180	14	3628,25
		3/4" T Kol Sliding T Handle			
		3/4" Ara Kol Extension Bar 200 mm			
		3/4" Ara Kol Extension Bar 400 mm			

1120

3/4" On İki Köşe Lokma Anahtar Takımı (14 parça, mm)
Socket Wrench Set 12 Points (14 pcs, mm)



3/4"

KOD CODE	LOKMALAR Sockets	AVADANLIKLAR Accessories	g	□	TL/Ad.
1120 00 6014	22 - 24 - 27 30 - 32 - 34 36 - 41 - 46 50	3/4" Cırcır Kolu Ratchet Handle	13700	14	3716,90
		3/4" T Kol Sliding T Handle			
		3/4" Ara Kol Extension Bar 200 mm			
		3/4" Ara Kol Extension Bar 400 mm			

1419

3/4" On İki Köşe Lokma Anahtar Takımı (14 parça, SAE)
Socket Wrench Set 12 Points (14 pcs, SAE)



3/4"

KOD CODE	LOKMALAR Sockets	AVADANLIKLAR Accessories	g	□	TL/Ad.
1419 00 6114	15/16" - 1 1/16" 1 1/8" - 1 1/4" 1 5/16" 1 3/8" 1 1/2" - 1 5/8" 1 7/8" - 2"	3/4" Cırcır Kolu Ratchet Handle	10180	14	3865,65
		3/4" T Kol Sliding T Handle			
		3/4" Ara Kol Extension Bar 200 mm			
		3/4" Ara Kol Extension Bar 400 mm			

1225

1" On İki Köşe Lokma Anahtar (mm)
Socket Wrench 12 Points (mm)

TS ISO 2727-1
DIN 3124

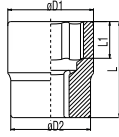

1"

Krom vanadyum, Krom kaplı
Chrom vanadium, Chrom plated

KOD CODE	Ø mm	Ø D1 mm	Ø D2 mm	L mm	L1 mm	g	TL/Ad.
1225 06 0036	36	52	48	65	26	525	1 299,20
1225 06 0041	41	58	50	70	29	665	1 325,70
1225 06 0046	46	65	54	75	32	900	1 394,90
1225 06 0050	50	70	57	75	34	1040	1 467,75
1225 06 0055	55	76	57	83	42	1250	1 599,00
1225 06 0060	60	82	60	87	46	1505	1 778,60

1525

1" Lokma Adaptörü
Adapter

TS ISO 3316
DIN 3123



1"

Krom vanadyum, Krom kaplı
Chrom vanadium, Chrom plated

KOD CODE	inch	g	TL/Ad.
1525 06 0005	1"Fx3/4"M	330	5 188,30

1113

1/2" Alaşımli Jant Lokma Takımı (3 Parca, mm)
Combination Lug Nut Socket Set (3 Pcs, mm)



1/2"

KOD CODE	LOKMARLAR Sockets	g	TL/Ad.
1113 00 9003	17-19-21	800	3 504,10



(*) İşaretili olan ürünler stoklarla sınırlıdır.

1113

1/2" Altı Köşe Havalı Lokma Anahtar (mm)
Impact Socket Wrench 6 Points (mm)

TS ISO 2725-2



İZELTAS YOUTUBE



1/2"

Krom molibden, Fosfat kaplamalı
Chrom molybdenum, Phosphate finish

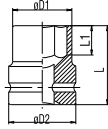

KOD CODE	mm	Ø D1 mm	Ø D2 mm	L mm	L1 mm	g	TL/Ad.	
1113 06 7010	10	17	25	38	8	70	10	42,85
1113 06 7011	11	18	25	38	8	70	10	42,85
1113 06 7012	12	19	25	38	9	70	10	42,85
1113 06 7013	13	20	25	38	10	70	10	45,90
1113 06 7014	14	22	25	38	10	75	10	45,90
1113 06 7015	15	23	30	38	11	110	10	52,90
1113 06 7016	16	24	30	38	11	110	10	55,40
1113 06 7017	17	26	30	38	12	115	10	55,45
1113 06 7018	18	27	30	38	13	115	10	55,60
1113 06 7019	19	28	30	38	13	120	10	56,80
1113 06 7021	21	30	30	40	14	125	5	59,70
1113 06 7022	22	32	30	40	14	145	5	61,60
1113 06 7024	24	34	30	42	15	150	5	70,70
1113 06 7027	27	38	30	44	16	175	5	89,95

1513

1/2" Havalı Lokma Ara Kol
Impact Socket Extension Bar



1/2"

Krom molibden, Fosfat kaplamalı
Chrom molybdenum, Phosphate finish

KOD CODE	L mm	g	TL/Ad.	
1513 06 7125	125	275	5	163,25

1108

1/2" Altı Köşe Havalı Derin Lokma Anahtar (mm)
6 Point Impact Socket Wrench, Long Type (mm)



1/2"



Krom molibden, Fosfat kaplamalı
Chrom molybdenum, Phosphate finish

KOD CODE	mm	L mm	g	TL/Ad.	
1108 06 7010	10	80	136	10	81,75
1108 06 7011	11	80	144	10	81,75
1108 06 7012	12	80	157	10	81,75
1108 06 7013	13	80	157	10	88,75
1108 06 7014	14	80	172	10	88,75
1108 06 7015	15	80	223	10	99,10
1108 06 7016	16	80	230	10	99,10
1108 06 7017	17	80	240	10	99,10
1108 06 7018	18	80	255	10	99,10
1108 06 7019	19	80	236	10	99,10
1108 06 7021	21	80	240	10	103,35
1108 06 7022	22	80	296	5	103,35
1108 06 7024	24	80	308	5	109,25
1108 06 7027	27	80	356	5	144,55
1108 06 7030	30	80	416	5	161,90
1108 06 7032	32	80	510	5	172,65

1513

1/2" Havalı Lokma Adaptörü
Impact Socket Adapter



1/2"

Krom molibden, Fosfat kaplamalı
Chrom molybdenum, Phosphate finish

KOD CODE	inch	g	TL/Ad.	
1513 06 7002	1/2"Fx3/8"M	95	5	108,00
1513 06 7003	1/2"Fx3/4"M	175	5	123,25

1513

1/2" Havalı Lokma Mafsal
Impact Socket Universal Joint



1/2"

Krom molibden, Fosfat kaplamalı
Chrom molybdenum, Phosphate finish

KOD CODE	L mm	g	TL/Ad.	
1513 06 7075	75	220	5	207,25

(★) İşaretli olan ürünler stoklarla sınırlıdır.

1119

3/4" Altı Köşe Havalı Lokma Anahtar (mm) Impact Socket Wrench 6 Points (mm)



3/4"

Krom molibden, Fosfat kaplamalı
Chrom molybdenum, Phosphate finish

KOD CODE	mm	Ø D1 mm	Ø D2 mm	L mm	L1 mm	g	TL/Ad.
1119 06 7019	19	32	44	50	13	330	5 144,55
1119 06 7021	21	35	44	50	15	340	5 144,55
1119 06 7022	22	36	44	50	15	345	5 144,55
1119 06 7024	24	38	44	50	16	350	5 144,55
1119 06 7027	27	42	44	53	17	380	5 148,65
1119 06 7030	30	46	44	53	20	410	1 160,20
1119 06 7032	32	48	44	57	20	460	1 160,20
1119 06 7034	34	51	44	57	22	490	1 208,85
1119 06 7036	36	53	44	57	22	520	1 208,85
1119 06 7041	41	59	44	58	24	580	1 322,25
1119 06 7046	46	66	44	62	24	715	1 342,55

1519

3/4" Havalı Lokma Ara Kol Impact Socket Extension Bar



3/4"

Krom molibden, Fosfat kaplamalı
Chrom molybdenum, Phosphate finish

KOD CODE	L mm	g	TL/Ad.
1519 06 7175	175	865	5 356,10
1519 06 7250	250	1155	5 509,25
1519 06 7330	330	1425	5 772,90

1519

3/4" Havalı Lokma Mafsal Impact Socket Universal Joint



3/4"

Krom molibden, Fosfat kaplamalı
Chrom molybdenum, Phosphate finish

KOD CODE	L mm	g	TL/Ad.
1519 06 7108	108	735	5 593,15

1519

3/4" Havalı Lokma Adaptörü Impact Socket Adapter



3/4"

Krom molibden, Fosfat kaplamalı
Chrom molybdenum, Phosphate finish

KOD CODE	inch	g	TL/Ad.
1519 06 7011	3/4"Fx1/2"M	315	5 205,55



(*) İşaretili olan ürünler stoklarla sınırlıdır.

1125

1" Altı Köşe Havalı Lokma Anahtar (mm) Impact Socket Wrench 6 Points (mm)



1"

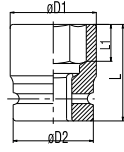

Krom molibden, Fosfat kaplamalı
Chrom molybdenum, Phosphate finish

KOD CODE	mm	σ D1 mm	σ D2 mm	L mm	L1 mm	g	TL/Ad.
1125 06 7024	24	41	54	58	17	560	1 260,25
1125 06 7027	27	44	54	58	19	565	1 262,55
1125 06 7030	30	48	54	60	21	605	1 264,75
1125 06 7032	32	51	54	62	21	650	1 267,90
1125 06 7033	33	52	54	62	21	660	1 267,90
1125 06 7034	34	53	54	62	24	765	1 269,30
1125 06 7036	36	56	54	65	24	720	1 270,60
1125 06 7038	38	58	54	65	26	735	1 281,70
1125 06 7041	41	61	54	70	28	845	1 343,35
1125 06 7046	46	68	54	75	30	1075	1 378,80
1125 06 7050	50	73	54	75	32	1170	1 404,00
1125 06 7055	55	79	54	83	37	1435	1 535,65
1125 06 7060	60	86	54	87	37	1760	1 669,45

1525

1" Havalı Lokma Ara Kol Impact Socket Extension Bar



1"

Krom molibden, Fosfat kaplamalı
Chrom molybdenum, Phosphate finish

KOD CODE	L mm	g	TL/Ad.
1525 06 7175	175	1395	5 649,55
1525 06 7250	250	1890	5 834,65
1525 06 7330	330	2455	5 1014,70

1525

1" Havalı Lokma Mafsal Impact Socket Universal Joint



1"

Krom molibden, Fosfat kaplamalı
Chrom molybdenum, Phosphate finish

KOD CODE	L mm	g	TL/Ad.
1525 06 7128	128	1530	1 1211,30

1525

1" Havalı Lokma Adaptörü Impact Socket Adapter



1"

Krom molibden, Fosfat kaplamalı
Chrom molybdenum, Phosphate finish

KOD CODE	inch	g	TL/Ad.
1525 06 7015	1"Fx3/4"M	560	5 248,50



1800

Kovan Anahtar İki Ağız (mm) Double Ended Tubular Socket Wrench (mm)

TS ISO 3793
DIN 896

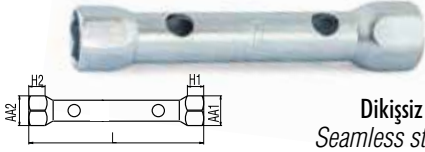

Dikişsiz çelik boru, Çinko kaplı
Seamless steel tube, Zinc plated

KOD CODE	mm	L mm	AA1 mm	AA2 mm	H1 mm	H2 mm	g	TL/Ad.	
1800 07 0607	6x7	105	8.6	9.6	7	8	25	5	44,30
1800 07 0809	8x9	105	11.2	12.2	9	10	35	5	48,65
1800 07 1011	10x11	120	13.6	14.6	11	11.5	55	5	66,75
1800 07 1213	12x13	135	16	17	12	12.5	80	5	70,75
1800 07 1415	14x15	135	18.5	19.5	13	13.5	110	5	77,55
1800 07 1617	16x17	150	21	22	14	14.5	150	5	83,30
1800 07 1819	18x19	150	23	24	15	15.5	170	5	86,35
1800 07 2022	20x22	165	25.4	27.4	16	18	220	5	95,10
1800 07 2224	22x24	180	27.4	29.4	18	20	330	5	106,80
1800 07 2427	24x27	180	30.4	33.4	20	23	400	5	138,10

1800

Kovan Anahtar Takımı İki Ağız (mil dahil, mm) Double Ended Tubular Socket Wrench Set with Tommy Bars (mm)



KOD CODE	mm	g	TL/Ad.
1800 00 2108	6x7 - 8x9 - 10x11 - 12x13 - 14x15 16x17 - 18x19 - 20x22 Mil/Handle Bars 5x125-8x180 mm	920	10

1841

Kovan Anahtar Bir Ağız (mil dahil) Single Ended Tubular Socket Wrench with Tommy Bar



Dikişsiz çelik boru, Çinko kaplı
Seamless steel tube, Zinc plated

KOD CODE	mm		L mm	ØD mm	Mil Handle bar mm	g	TL/Ad.
	mm	inch					
1841 07 0021	21	13/16"	120	20	10x120	215	5

1850

Kovan Anahtar Mili Tommy Bar

TS ISO 3793
DIN 900



KOD CODE	ØDxL mm	g	TL/Ad.	
1850 07 5125	5x125	20	10	17,50
1850 07 8180	8x180	70	10	26,75
1850 07 1120	10x120	75	10	30,35
1850 07 1200	10x200	120	10	34,15

1870

Ağır Tip Bijon Anahtarı İki Ağız Uzun Double Ended Rim Wrench (long)

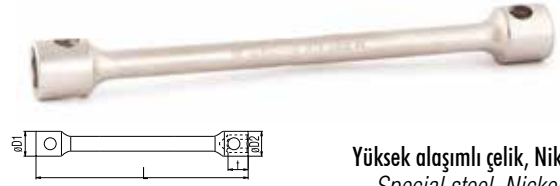

Yüksek alaşımli çelik, Nikel kaplı
Special steel, Nickel plated

KOD CODE	mm	L mm	t mm	ØD1 mm	ØD2 mm	g	TL/Ad.	
1870 09 2427	24x27	400	34.5	36	40	1135	10	184,80
1870 09 2730	27x30	400	34.5	40	44	1380	10	212,35
1870 09 2732	27x32	400	34.5	40	46	1380	10	212,35
1870 09 3032	30x32	400	34.5	44	46	1380	10	219,75
1870 09 3233	32x33	400	34.5	46	47	1450	10	243,85

1874

Ağır Tip Bijon Anahtarı İki Ağız Kısa Double Ended Rim Wrench (short)

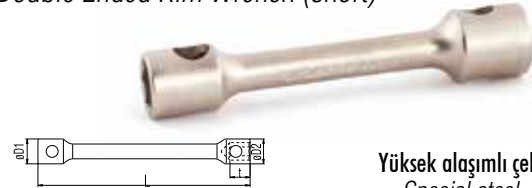

Yüksek alaşımli çelik, Nikel kaplı
Special steel, Nickel plated

KOD CODE	mm	L mm	t mm	ØD1 mm	ØD2 mm	g	TL/Ad.	
1874 09 2224	22x24	170	34.5	34	36	720	10	117,05
1874 09 2427	24x27	200	34.5	36	40	800	10	149,65

1850

Bijon Anahtar Mili Tommy Bar

TS ISO 3793
DIN 900



KOD CODE	ØDxL mm	g	TL/Ad.	
1850 09 1630	18x630	1260	1	107,55

(*) İşaretli olan ürünler stoklarla sınırlıdır.

1975

Bijon Anahtarı İstavroz Tipi Cross Rim Wrench

TS ISO 6788

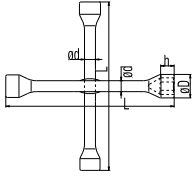

Yüksek alaşımlı çelik, Krom kaplı
Special steel, Chrom plated

KOD CODE	mm	inch	σD mm	h mm	L mm	σd mm	g	TL/Ad.
	17	11/16"	28	17				
1975 09 1719	19	3/4"	30	18.5	420	16	1422	10 220,90
	21	13/16"	32	19.5				
	22	7/8"	34	20.5				

1975

1/2" Adaptörlü Bijon Anahtarı İstavroz Tipi Cross Rim Wrench (with 1/2" adapter)

TS ISO 6788

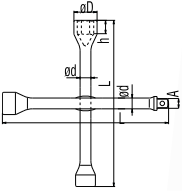

Yüksek alaşımlı çelik, Krom kaplı
Special steel, Chrom plated

KOD CODE	mm	inch	σD mm	h mm	L mm	A mm	σd mm	g	TL/Ad.
	17	11/16"	28	17					
1975 09 1322	19	3/4"	30	18.5	420	12.65	16	1375	10 224,90
	22	7/8"	34	20.5					
		1/2"							

1940

Bijon Anahtarı Pipo Tipi (Tornavida Ağızlı) Offset Socket Wrench with Screwdriver

TSEK

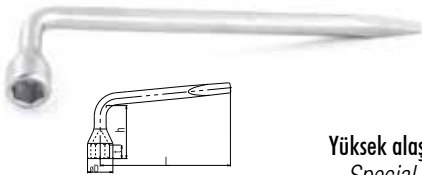

Yüksek alaşımlı çelik, Krom kaplı
Special steel, Chrom plated

KOD CODE	mm	inch	L mm	σD mm	h mm	g	TL/Ad.
1940 09 0017	17	11/16"	285	28	65	485	10 114,85
1940 09 0019	19	3/4"	285	30	65	470	10 121,30
1940 09 0021	21	13/16"	320	32	85	575	10 131,10

1840

1/2" Mafsallı T Kol Swivel Handle With Sliding T 1/2"

Özel alaşım çelik, Krom kaplı
Special steel, Chrom plated

1/2"

KOD CODE	mm	L mm	g	TL/Ad.
1840 08 0500	1/2"	600	740	10 469,15

1855

Mafsallı T Kol Lokma T - Handle Wrench with Universal Joint

Özel alaşım çelik, Krom kaplı
Special steel, Chrom plated

KOD CODE	mm	L mm	g	TL/Ad.
1855 08 0008	8	400	225	10 471,15
1855 08 0010	10	450	405	10 592,45
1855 08 0012	12	450	410	10 592,45
1855 08 0013	13	450	425	10 592,45
1855 08 0017	17	500	485	10 659,90
1855 08 0019	19	510	895	10 838,75

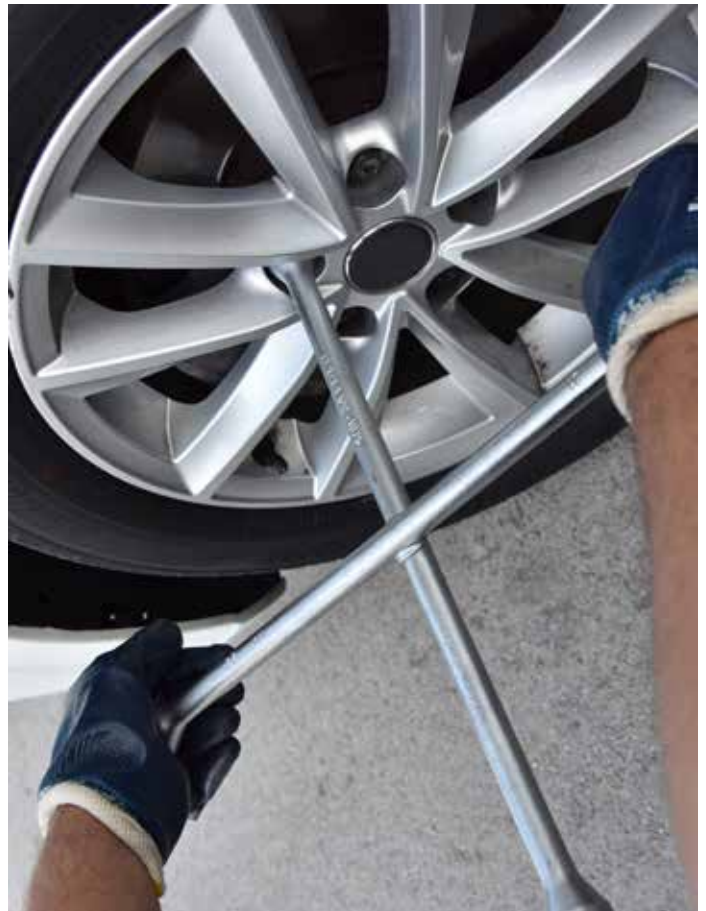

(*) İşaretili olan ürünler stoklarla sınırlıdır.

1610

3/8" Tork Anahtarı Torque Wrench

TS EN ISO 6789-1
TS EN ISO 6789-2



3/8"

KOD CODE	ÖLÇÜ SIZE	L mm	g	TL/Ad.
1610 06 0100	2.5 - 11 Nm - 0.3 - 1.2 Kg	310	515	1 2597,50
1610 06 0300	7 - 33 Nm - 0.5 - 3.4 Kg	425	640	1 2685,35

1613

1/2" Tork Anahtarı Torque Wrench

TS EN ISO 6789-1
TS EN ISO 6789-2



1/2"

KOD CODE	ÖLÇÜ SIZE	L mm	g	TL/Ad.
1613 06 1200	25 - 135 Nm - 3 - 14 Kg	550	1430	1 2773,25
1613 06 2000	50 - 225 Nm - 5 - 23 Kg	600	2165	1 2862,50
1613 06 3000	70 - 330 Nm - 7 - 35 Kg	830	2870	1 3483,15

1619

3/4" Tork Anahtarı Torque Wrench

TS EN ISO 6789-1
TS EN ISO 6789-2



İZELTAS USTA İŞİ
SOHBETLER

3/4"

KOD CODE	ÖLÇÜ SIZE	L mm	g	TL/Ad.
1619 06 2080	200 - 800 Nm-22-82 kg	1030	8860	1 10733,65

1607

1/4" Cırcırlı Tork Anahtar Torque Wrench With Reversible Ratchet-Head

TS EN ISO 6789-1
TS EN ISO 6789-2



İZELTAS YOUTUBE

1/4"

KOD CODE	ÖLÇÜ SIZE	L mm	g	TL/Ad.
1607 06 0420	4 - 20 Nm	320	640	1 2056,10

1610

3/8" Cırcırlı Tork Anahtar Torque Wrench With Reversible Ratchet-Head

TS EN ISO 6789-1
TS EN ISO 6789-2



3/8"

KOD CODE	ÖLÇÜ SIZE	L mm	g	TL/Ad.
1610 06 2010	20 - 100 Nm	435	1300	1 2321,45

1613

1/2" Cırcırlı Tork Anahtar Torque Wrench With Reversible Ratchet-Head

TS EN ISO 6789-1
TS EN ISO 6789-2



1/2"

KOD CODE	ÖLÇÜ SIZE	L mm	g	TL/Ad.
1613 06 4020	40- 200Nm	520	1590	1 2719,20
1613 06 6034	60- 340Nm	610	1810	1 2850,85

1619

3/4" Cırcırlı Tork Anahtar Torque Wrench With Reversible Ratchet-Head

TS EN ISO 6789-1
TS EN ISO 6789-2



3/4"

KOD CODE	ÖLÇÜ SIZE	L mm	g	TL/Ad.
1619 06 1060	100-600 Nm	1050	5600	1 7539,85

(*) İşaretli olan ürünler stoklarla sınırlıdır.



İZELTAS®

BORU ANAHTARLARI VE PENSELER

PIPE WRENCHES AND PLIERS

Boru Anahtarları
Pipe Wrenches

Fort Penseler
Water Pump Pliers

Ayarlı Penseler
Grip Wrenches

Penseler
Pliers

Kargaburunlar
Nose Pliers

Kerpetenler
Carpenter Pincers

Elektronikçi Penseler
Electronic Pliers



İZELTAS YOUTUBE

PIPE WRENCHES
AND PLIERS

BORU
ANAHTARLARI
PENSELER

KOMBİNE PENSE KRAFT SERİ/COMBINATION PLIERS

Güçlü kavrama sağlayan
tırnaklı tutma yüzeyleri
Toothed surface for strong grip

Isıl işlem sonrasında indüksiyonda
sertleştirme ile kullanım ömrü
artırılmış kesici ağızlar
Heat-treated and induction hardened cutting edges for long
lifetime

Nikel üzerine krom kaplama ile
korozyon direncinde
üst seviye koruma
High corrosion resistance
with chrome over nickel plating

Yüksek karbonlu
sıcak dövme
çeliği ile artırılmış
dayanım
High carbon forged steel for
improved durability

Düşmelere ve darbeye dayanıklı,
selüloz asetat ergonomik sap
Impact resistant cellulose acetate handle



2100



Stilson Boru Anahtarı Pipe Wrench, Stilson



TS 3796



 Yedek parça sayfa 198
Spare parts page 198

KOD CODE	L mm	L inch	 mm	ÖLÇÜ SIZE Inch	 g		TL/Ad.
2100 10 0008	200	8"	27	3/4"	280	1	289,85
2100 10 0010	250	10"	34	1"	550	1	348,55
2100 10 0012	300	12"	42	1 1/4"	725	1	392,15
2100 10 0014	350	14"	50	1 1/2"	1030	1	481,35
2100 10 0018	450	18"	60	2"	1775	1	611,10
2100 10 0024	600	24"	76	2 1/2"	2775	1	984,60



2110

Ağır Tip Boru Anahtarı Pipe Wrench, Heavy Duty



 Yedek parça sayfa 198
Spare parts page 198

Krom vanadyum, Dişler indüksiyonda sertleştirilmiş, Elektrostatik boyanmış
Chrom vanadium, Teeth induction hardened, Electrostatically painted

KOD CODE	L mm	L inch	 mm	ÖLÇÜ SIZE Inch	 g		TL/Ad.
2110 10 0008	200	8"	34	1"	425	1	384,85
2110 10 0010	250	10"	42	1 1/4"	795	1	477,70
2110 10 0012	300	12"	50	1 1/2"	1245	1	547,15
2110 10 0014	350	14"	60	2"	1710	1	636,95
2110 10 0018	450	18"	75	2 1/2"	2685	1	888,65
2110 10 0024	600	24"	90	3"	4370	1	1433,05
2110 10 0036	900	36"	140	5"	7600	1	3174,25
2110 10 0048	1200	48"	165	6"	15600	1	6501,30

2201

Maşalı Boru Anahtarı (85°) Pipe Wrench (85°)





TS 3796
DIN 5234



 Yedek parça sayfa 198
Spare parts page

Krom vanadyum, Dişler indüksiyonda sertleştirilmiş, Elektrostatik boyanmış
Chrom vanadium, Teeth induction hardened, Electrostatically painted

KOD CODE	L mm	 mm	ÖLÇÜ SIZE Inch	 g		TL/Ad.
2201 10 0010	325	40	1"	870	1	295,10
2201 10 0015	430	60	1 1/2"	1585	1	456,95
2201 10 0020	585	70	2"	2700	1	684,20
2201 10 0030	690	100	3"	4270	1	1037,25
2201 10 0040	760	130	4"	5800	1	1555,75

(★) İşaretili olan ürünler stoklarla sınırlıdır.

Üniversal Fort Pense
Waterpump Pliers UniversalTS 60 TS ISO 8976
DIN ISO 8976

İZELTAŞ YOUTUBE

Krom vanadyum, Krom kaplı, PVC izoleli
Chrom vanadium, Chrom plated, PVC insulated

KOD CODE	L mm	L inch	mm	g	TL/Ad.
2400 11 0160	160	6 1/4"	30	125	5 180,70
2400 11 0240	240	9 1/2"	35	355	5 252,65
2400 11 0315	315	12 1/2"	40	530	5 413,85

1000V İzoleli Üniversal Fort Pense
Insulated Type Waterpump Pliers Universal 1000VTS 60
TS ISO 8976**Krom vanadyum, Krom kaplı, çift komponent saplı**
Chrom vanadium, Chrom plated, Two component handle

KOD CODE	L mm	L inch	mm	g	TL/Ad.
2400 11 6240	240	9 1/2"	35	370	5 293,15

Yaylı Fort Pense
Waterpump Pliers With SpringİZELTAŞ USTA İŞİ
SOHBETLER**Krom vanadyum, Karartma, PVC izoleli**
Chrom vanadium, Black finish, PVC insulated

KOD CODE	L mm	L inch	mm	g	TL/Ad.
2415 11 0240	240	9 1/2"	35	365	5 340,90

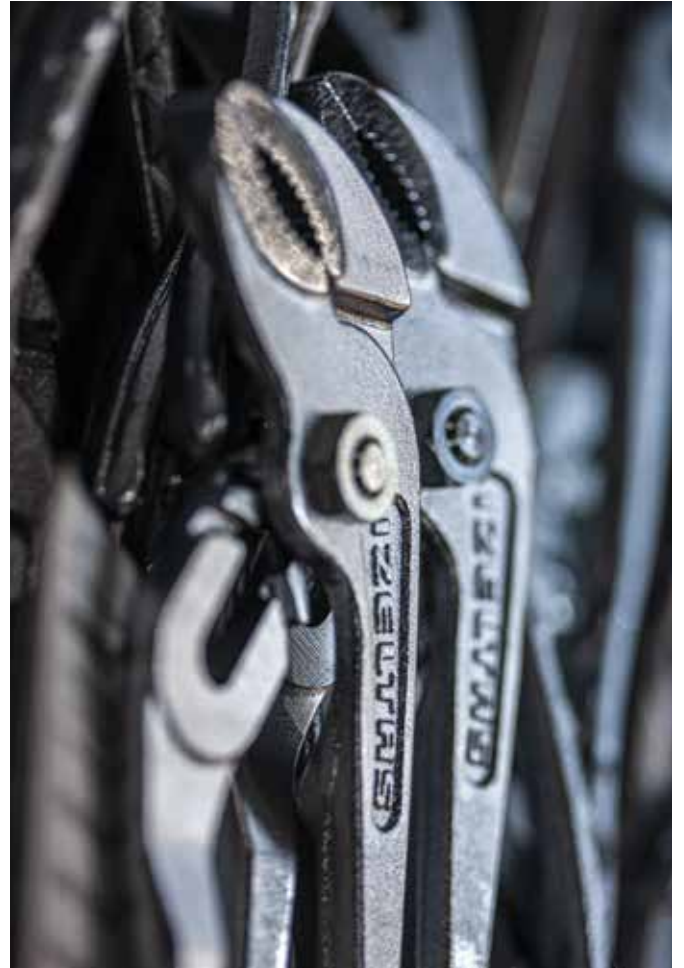

(*) İşaretili olan ürünler stoklarla sınırlıdır.

2500

Üniversal Ayarlı Pense Universal Grip



Çeneler krom vanadyum çeliğinden dövülmüştür, Nikel kaplama,
Kullanım sahası: Yuvarlak ve düz malzemeler
Jaws Chrom vanadium forged, Nickel plated
Application field : Flat and round materials

KOD CODE	L mm	L inch	mm	g	TL/Ad.
2500 11 0250	250	10"	30	560	5 300,95

2510

Spesiyal Ayarlı Pense Special Grip



Çeneler krom vanadyum çeliğinden dövülmüştür, Nikel kaplama,
Kullanım sahası: Yuvarlak ve düz malzemeler
Jaws Chrom vanadium forged, Nickel plated
Application field: Flat and round materials

KOD CODE	L mm	L inch	mm	g	TL/Ad.
2510 11 0250	250	10"	30	550	5 300,95

2505

Standart Ayarlı Pense Standard Grip

TSEK



Çeneler krom vanadyum çeliğinden dövülmüştür, Nikel kaplama
Kullanım sahası: Düz malzemeler
Jaws, Chrom vanadium forged, Nickel plated
Application field: Flat materials

KOD CODE	L mm	L inch	mm	g	TL/Ad.
2505 11 0250	250	10"	30	535	5 300,95

2511

C tipi Ayarlı Pense Clamp Grip C-type



Çeneler krom vanadyum çeliğinden dövülmüştür, Nikel kaplama,
Kullanım sahası: Açılı profillerin tutulmasında
Jaws Chrom vanadium forged, Nickel plated
Application field: For Gripping angled sheet metal

KOD CODE	L mm	L inch	mm	g	TL/Ad.
2511 11 0280	280	11"	70	700	1 503,20

(*) İşaretili olan ürünler stoklarla sınırlıdır.

Kaynakçı Ayarlı Pense (Düz Ağız)
Lock Grip With Flat Jaws

Özel alaşımli çelikten imal edilmiş, Nikel kaplama,
Kullanım sahası: 80 mm düz çeneleri ile kıvrık metal levhaları
*Made from special alloy steel, Nickel plated, Application field:
Gripping sheet metals with 80 mm Flat jaws*

KOD CODE	L mm	L inch	mm	g	TL/Ad.
2512 11 0200	200	8"	30	485	1 507,85

Kaportacı Ayarlı Pense
Welding Grip

Özel alaşımli çelikten imal edilmiş- Nikel kaplama,
Kullanım sahası: Yassı ve köşeli malzemelerde
*Made from special alloy steel, Nickel plated
Application field : Angled corners and edges*

KOD CODE	L mm	L inch	mm	g	TL/Ad.
2515 11 0270	270	10 5/8"	50	765	1 403,10

Kaynakçı Ayarlı Pense (Boru İçin)
Grip For Tubes

Özel alaşımli çelikten imal edilmiş, Nikel kaplama,
Kullanım sahası: Boru malzemeler
Made from special alloy steel, Nickel plated, Application field: Tubes

KOD CODE	L mm	L inch	mm	g	TL/Ad.
2513 11 0280	280	11"	50	800	1 507,85



(*) İşaretili olan ürünler stoklarla sınırlıdır.

3020

Kombine Pense Opak Seri Combination Pliers

TS 60
TS ISO 5746
DIN ISO 5746



İZELTAS YOUTUBE

Özel alaşımli çelik, Kesici ağızlar indüksiyonda sertleştirilmiş
Special steel, Cutters induction hardened

KOD CODE	L mm	L inch	g	TL/Ad.
3020 12 2160	160	6 1/4"	205	5 157,00
3020 12 2180	180	7 1/8"	275	5 178,20
3020 12 2200	200	8"	315	5 201,15

3020

Kombine Pense Kraft Seri Combination Pliers

TS 60
TS ISO 5746
DIN ISO 5746



Özel alaşımli çelik, Kesici ağızlar indüksiyonda sertleştirilmiş
Special steel, Cutters induction hardened

KOD CODE	L mm	L inch	g	TL/Ad.
3020 12 3160	160	6 1/4"	225	5 192,40
3020 12 3180	180	7 1/8"	285	5 215,00
3020 12 3200	200	8"	380	5 242,85

★3020

Kombine Pense Ergonomik Seri Combination Pliers

TS 60
TS ISO 5746
DIN ISO 5746



Özel alaşımli çelik, Kesici ağızlar indüksiyonda sertleştirilmiş
Special steel, Cutters induction hardened

KOD CODE	L mm	L inch	g	TL/Ad.
★3020 12 5160	160	6 1/4"	205	5 197,55
★3020 12 5180	180	7 1/8"	260	5 224,35
★3020 12 5200	200	8"	345	5 253,25

3020

1000V İzoleli Elektrikçi Kombine Pense Electrician Type Insulated Combination Pliers 1000V



TS 60
TS ISO 5746
DIN ISO 5746



1000 V
IEC 60900



Özel alaşımli çelik, Kesici ağızlar indüksiyonda sertleştirilmiş, Krom kaplı
Special steel, Cutters induction hardened, Chrom plated

KOD CODE	L mm	L inch	g	TL/Ad.
3020 12 6160	160	6 1/4"	205	5 216,25
3020 12 6180	180	7 1/8"	260	5 231,50
3020 12 6200	200	8"	345	5 261,35

3030

Kombine Pense Ağır Tip (çelik tel için) Combination Pliers Heavy Duty (for piano wire)



Özel alaşımli çelik, Kesici ağızlar indüksiyonda sertleştirilmiş,
Special steel, Cutters induction hardened

KOD CODE	L mm	L inch	g	TL/Ad.
3030 12 2180	180	7 1/8"	285	5 268,50
3030 12 2200	200	8"	380	5 307,05

(★) İşaretili olan ürünler stoklarla sınırlıdır.

3220

Kargaburun Düz Uçlu Opak Seri
Long Nose Pliers (Flat)

TS 60 - TS ISO 5745
DIN ISO 5745



İZELTAS YOUTUBE

Özel alaşımli çelik, Kesici ağızlar indüksiyonda sertleştirilmiş
Special steel, Cutters induction hardened

KOD CODE	L mm	L inch	g	□	TL/Ad.
3220 13 2140	140	5 1/2"	110	5	154,70
3220 13 2160	160	6 1/4"	135	5	174,85
3220 13 2180	180	7 1/8"	170	5	192,15
3220 13 2200	200	8"	205	5	203,80

3220

Kargaburun Düz Uçlu Kraft Seri
Long Nose Pliers (Flat)

TS 60 - TS ISO 5745
DIN ISO 5745



Özel alaşımli çelik, Kesici ağızlar indüksiyonda sertleştirilmiş
Special steel, Cutters induction hardened

KOD CODE	L mm	L inch	g	□	TL/Ad.
3220 13 3140	140	5 1/2"	120	5	191,00
3220 13 3160	160	6 1/4"	155	5	215,50
3220 13 3180	180	7 1/8"	185	5	237,15
3220 13 3200	200	8"	210	5	251,35

★3220

Kargaburun Düz Uçlu Ergonomik Seri
Long Nose Pliers (Flat)

TS 60 - TS ISO 5745
DIN ISO 5745



Özel alaşımli çelik, Kesici ağızlar indüksiyonda sertleştirilmiş
Special steel, Cutters induction hardened

KOD CODE	L mm	L inch	g	□	TL/Ad.
★3220 13 5140	140	5 1/2"	110	5	200,90
★3220 13 5160	160	6 1/4"	140	5	227,15
★3220 13 5180	180	7 1/8"	160	5	249,70
★3220 13 5200	200	8"	170	5	264,55

3220

1000V İzoleli Elektrikçi Kargaburun Düz Uçlu
Insulated Electrician Type
Long Nose Pliers 1000V



TS 60
TS ISO 5745
DIN ISO 5745
⚡ 1000
IEC 60900



Özel alaşımli çelik, Kesici ağızlar indüksiyonda sertleştirilmiş, Krom kaplı
Special steel, Cutters induction hardened, Chrom plated

KOD CODE	L mm	L inch	g	□	TL/Ad.
3220 13 6140	140	5 1/2"	110	5	221,25
3220 13 6160	160	6 1/4"	140	5	244,65
3220 13 6180	180	7 1/8"	160	5	274,60
3220 13 6200	200	8"	170	5	285,15

(★) İşaretli olan ürünler stoklarla sınırlıdır.

3225
Kargaburun Eğri Uçlu Opak Seri
Long Nose Pliers (Bent)

TS 60 - TS ISO 5745

 Özel alaşımlı çelik, Kesici ağızlar indüksiyonda sertleştirilmiş
Special steel, Cutters induction hardened

KOD CODE	L mm	L inch	g	TL/Ad.
3225 13 2160	160	6 1/4"	140	5 184,75
3225 13 2180	180	7 1/8"	170	5 208,75
3225 13 2200	200	8"	175	5 223,05

3225
Kargaburun Eğri Uçlu Kraft Seri
Long Nose Pliers (Bent)

TS 60 - TS ISO 5745

 Özel alaşımlı çelik, Kesici ağızlar indüksiyonda sertleştirilmiş
Special steel, Cutters induction hardened

KOD CODE	L mm	L inch	g	TL/Ad.
3225 13 3160	160	6 1/4"	150	5 222,15
3225 13 3180	180	7 1/8"	190	5 243,95
3225 13 3200	200	8"	195	5 268,35

3020 00 2003
Opak Pense Seti 160mm (3 Parça)
Opak Pliers Set 160mm (3 Pcs)
ANAHTARLIK HEDİYELİ

KOD CODE	L mm	İÇERİK CONTENTS	TL Ad.
3020 12 2160	160	Kombine Pense Opak Seri Combination Pliers 160mm	1 528,55
3220 13 2160	160	Kargaburun Düz Uçlu Opak Seri Long Nose Pliers (Flat) 160mm	1 528,55
3700 16 2160	160	Yan Keski Opak Seri Side Cutting Pliers 160mm	1 528,55

3020 00 1002
Pense Kontrol Kalemi Set (2 Parça)
Opak Pliers Set, Voltage Tester (Flat) 2 Pcs
ANAHTARLIK HEDİYELİ

KOD CODE	L mm	İÇERİK CONTENTS	TL Ad.
3020 12 2160	160	Kombine Pense Opak Seri Combination Pliers 160mm	1 198,55
4550 17 0190	190	Elektrik Kontrol Kalemi (Düz Uçlu) Voltage Tester (Flat) 190mm	1 198,55

(*) İşaretli olan ürünler stoklarla sınırlıdır.

3700

Yan Keski Opak Seri Side Cutting Pliers

TS 60 - TS ISO 5749
DIN ISO 5749



İZELTAS YOUTUBE

Özel alaşımli çelik, Kesici ağızlar indüksiyonda sertleştirilmiş
Special steel, Cutters induction hardened

KOD CODE	L mm	L inch	g	TL/Ad.
3700 16 2140	140	5 1/2"	165	163,45
3700 16 2160	160	6 1/4"	230	196,70
3700 16 2180	180	7 1/8"	230	229,50

3700

Yan Keski Kraft Seri Side Cutting Pliers

TS 60 • DIN ISO 5749
DIN ISO 5749



Özel alaşımli çelik, Kesici ağızlar indüksiyonda sertleştirilmiş
Special steel, Cutters induction hardened

KOD CODE	L mm	L inch	g	TL/Ad.
3700 16 3140	140	5 1/2"	190	197,05
3700 16 3160	160	6 1/4"	240	236,75
3700 16 3180	180	7 1/8"	255	275,85

★3700

Yan Keski Ergonomik Seri Side Cutting Pliers

TS 60 - TS ISO 5749
DIN ISO 5749



Özel alaşımli çelik, Kesici ağızlar indüksiyonda sertleştirilmiş
Special steel, Cutters induction hardened

KOD CODE	L mm	L inch	g	TL/Ad.
★3700 16 5140	140	5 1/2"	165	212,55
★3700 16 5160	160	6 1/4"	215	245,75
★3700 16 5180	180	7 1/8"	215	286,60

3700

1000V İzoleli Elektrikçi Yan Keski Insulated Electrician Type Side Cutter 1000V

TS 60
TS ISO 5749
DIN ISO 5749
⚡ 1000 V
IEC 60900



Özel alaşımli çelik, Kesici ağızlar indüksiyonda sertleştirilmiş, Krom kaplı
Special steel, Cutters induction hardened, Chrom plated

KOD CODE	L mm	L inch	g	TL/Ad.
3700 16 6140	140	5 1/2"	165	248,00
3700 16 6160	160	6 1/4"	215	281,50
3700 16 6180	180	7 1/8"	225	314,95

(★) İşaretili olan ürünler stoklarla sınırlıdır.

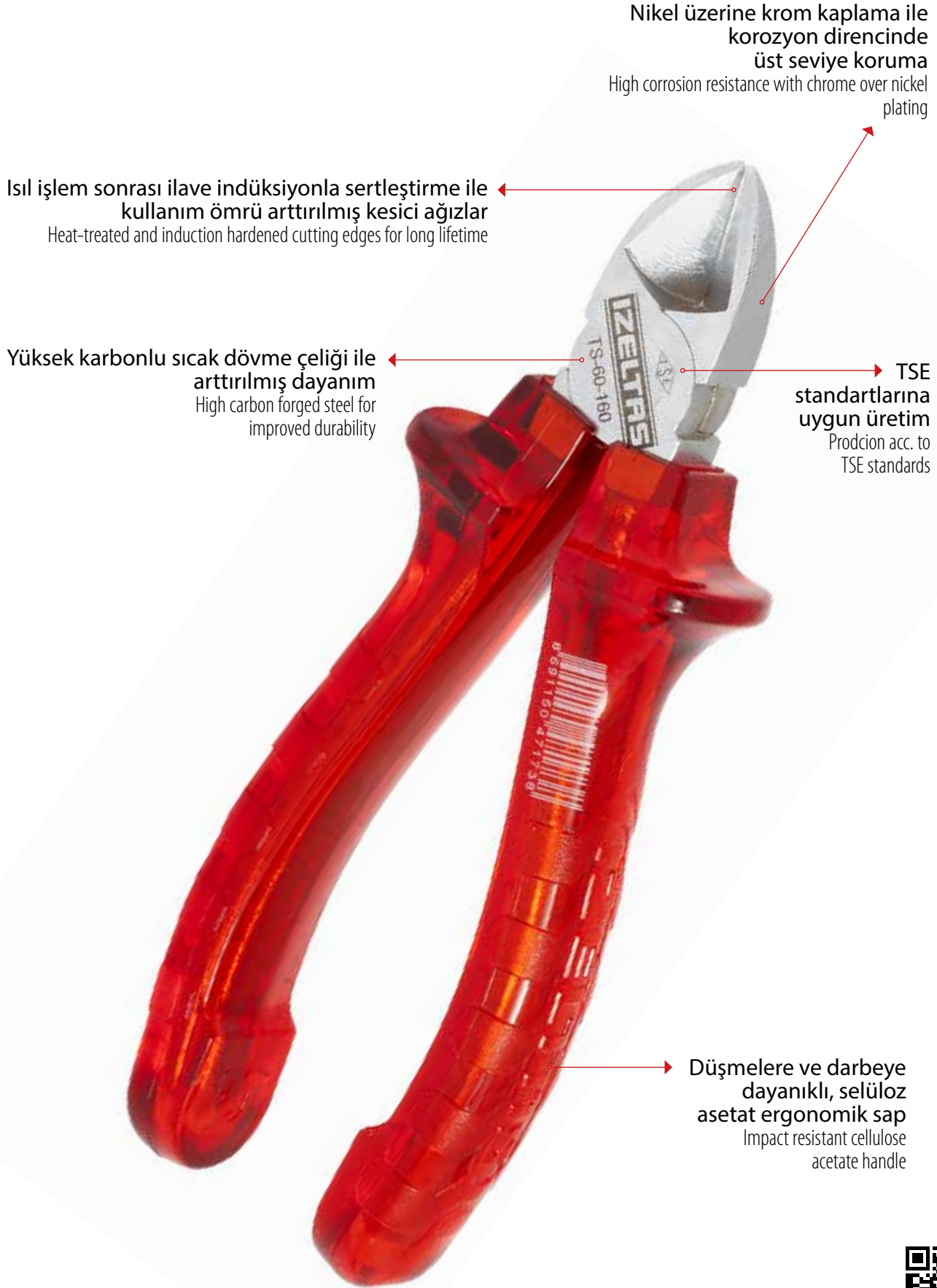
YAN KESKİ KRAFT SERİ / SIDE CUTTING PLIERS

Isıl işlem sonrası ilave indüksiyonla sertleştirme ile kullanım ömrü arttırılmış kesici ağızlar
Heat-treated and induction hardened cutting edges for long lifetime

Yüksek karbonlu sıcak dövme çeliği ile arttırılmış dayanım
High carbon forged steel for improved durability

Nikel üzerine krom kaplama ile korozyon direncinde üst seviye koruma
High corrosion resistance with chrome over nickel plating

TSE standartlarına uygun üretim
Prodion acc. to TSE standards

Düşmelere ve darbeye dayanıklı, selüloz asetat ergonomik sap
Impact resistant cellulose acetate handle



İZELTAS YOUTUBE

(★) İşaretili olan ürünler stoklarla sınırlıdır.

İnce Uçlu Yan Keski (Plastikler İçin)
Side Cutter For Plastics

TS 60
TS ISO 5749



Yan Keski Ağır Tip (Çelik Tel İçin)
Side Cutter Heavy Duty (for piano wire)



Özel alaşımli çelik, Kesici ağızlar induksiyonda sertleştirilmiş, PVC izoleli
Special steel, Cutters induction hardened, PVC insulated

Özel alaşımli çelik, Kesici ağızlar induksiyonda sertleştirilmiş
Special steel, Cutters induction hardened

KOD CODE	L mm	L inch	g	TL/Ad.
3705 16 5160	160	6 1/4"	220	5 255,95

KOD CODE	L mm	L inch	g	TL/Ad.
3730 16 2160	160	6 1/4"	200	5 279,05
3730 16 2200	200	8"	320	5 362,70

3335 00 1004

Segman Pense Takımı (4 Parça)
Circlip Pliers Set (4 Pcs)



330112 0180
Dış Segman Pense (Düz) ● 19-60



3311 12 0170
Dış Segman Pense (Eğri) ● 19-60



3321 12 0180
İç Segman Pense (Düz) ● 19-60



3331 12 0170
İç Segman Pense (Eğri) ● 19-60



İZELTAS YOUTUBE

KOD CODE	L mm	İÇERİK CONTENTS	TL Ad.
3301 12 0180	180	Dış Segman Pense (Düz) Circlip Pliers, External (Flat)	783,60
3311 12 0170	170	Dış Segman Pense (Eğri) Circlip Pliers, External (Bent)	
3321 12 0180	180	İç Segman Pense (Düz) Circlip Pliers, Internal (Flat)	
3331 12 0170	170	İç Segman Pense (Eğri) Circlip Pliers, Internal (Bent)	

(★) İşaretili olan ürünler stoklarla sınırlıdır.

3301

Dış Segman Pense (Düz) Circlip Pliers, External (Flat)



TS 60
DIN 5254



Krom vanadyum, Krom kaplı, PVC izoleli
Chrom vanadium, Chrom plated, PVC insulated

KOD CODE	L mm	⌀	g	□	TL/Ad.
3301 12 0140	140	10 - 25	90	5	184,60
3301 12 0180	180	19 - 60	195	5	194,60
3301 12 0225	225	40 - 100	235	5	243,20
3301 12 0295	295	85 - 140	445	5	412,50

3311

Dış Segman Pense (Eğri) Circlip Pliers, External (Bent)



TS 60
DIN 5254



Krom vanadyum, Krom kaplı, PVC izoleli
Chrom vanadium, Chrom plated, PVC insulated

KOD CODE	L mm	⌀	g	□	TL/Ad.
3311 12 0125	125	10 - 25	105	5	206,30
3311 12 0170	170	19 - 60	190	5	217,30
3311 12 0210	210	40 - 100	250	5	249,70
3311 12 0275	275	85 - 140	445	5	433,10

3321

İç Segman Pense (Düz) Circlip Pliers Internal (Flat)



TS 60
DIN 5256



Krom vanadyum, Krom kaplı, PVC izoleli
Chrom vanadium, Chrom plated, PVC insulated

KOD CODE	L mm	⌀	g	□	TL/Ad.
3321 12 0140	140	12 - 25	100	5	169,95
3321 12 0180	180	19 - 60	185	5	179,35
3321 12 0225	225	40 - 100	250	5	223,25
3321 12 0310	310	85 - 140	445	5	383,05

3331

İç Segman Pense (Eğri) Circlip Pliers Internal (Bent)



TS 60
DIN 5256



Krom vanadyum, Krom kaplı, PVC izoleli
Chrom vanadium, Chrom plated, PVC insulated

KOD CODE	L mm	⌀	g	□	TL/Ad.
3331 12 0130	130	12 - 25	105	5	182,75
3331 12 0170	170	19 - 60	185	5	192,35
3331 12 0210	210	40 - 100	250	5	240,10
3331 12 0290	290	85 - 140	440	5	412,10



3420**Hortum Keleçe Pensesi**
Hose Clamp Pliers

KOD CODE	L mm	L inch	g	TL/Ad.
3420 12 0220	220	8 3/4"	185	5 328,15

3425**Hortum Keleçe Pensesi (Sıkıştırma Tipi)**
Hose Clamp Pliers

KOD CODE	L mm	L inch	g	TL/Ad.
3425 12 0220	235	9 1/4"	355	5 336,30

3852**Delik Zımba**
Revolving Punch PliersÖlçü / Size $\emptyset 2 - \emptyset 2.5 - \emptyset 3 - \emptyset 3.5 - \emptyset 4 - \emptyset 4.5$

KOD CODE	L mm	L inch	g	TL/Ad.
3852 24 0225	225	9"	270	5 229,55



3715

Tek Ağızlı Kablo Kesici
Cable Cutter



Özel alaşımlı çelik, Kesici ağızlar indüksiyonda sertleştirilmiş, PVC izoleli
Special steel, Cutters induction hardened, PVC insulated

KOD CODE	L mm	L inch	g	TL/Ad.
3715 16 0165	165	6 1/4	210	210,85

3715

1000V İzoleli Tek Ağızlı Kablo Kesici
Cable Cutter 1000V



⚡ 1000 V
IEC 60900

Özel alaşımlı çelik, Kesici ağızlar indüksiyonda sertleştirilmiş
Special steel, Cutters induction hardened

KOD CODE	L mm	L inch	g	TL/Ad.
3715 16 6165	165	6 1/4	230	248,70

(*) İşaretili olan ürünler stoklarla sınırlıdır.

Çift Ağızlı Kablo Kesici
Cable Cutter, Double Cutter

Özel alaşımli çelik, Kesici ağızlar indüksiyonda sertleştirilmiş, PVC izoleli
Special steel, Cutters induction hardened, PVC insulated

KOD CODE	L mm	L inch	g	TL/Ad.
3720 16 0220	220	9"	320	5 282,70

Testere Çaprazı
Saw - Setting Pliers

TSEK



Özel alaşımli çelik, İndüksiyonda sertleştirilmiş,
Naturul Vernikli, PVC izoleli
Special steel, induction hardened, PVC insulated

KOD CODE	L mm	L inch	g	TL/Ad.
3860 26 0180	180	7 1/8"	245	5 260,90



3550

Elektronikçi Yan Keski
Electronic Diagonal Side Cutting Pliers



Özel alaşımli çelik
Special steel

KOD CODE	L mm	g		TL/Ad.
3550 14 0125	125	76	5	224,10

3553

Elektronikçi Düz Uçlu Kargaburun
Electronic Flat Nose Pliers



Özel alaşımli çelik
Special steel

KOD CODE	L mm	g		TL/Ad.
3553 14 0150	150	88	5	202,25

3551

Elektronikçi Tepe Keski
Electronic End Cutting Pliers



Özel alaşımli çelik
Special steel

KOD CODE	L mm	g		TL/Ad.
3551 14 0125	125	77	5	209,15

3554

Elektronikçi Uzun Kargaburun
Electronic Long Nose Pliers



Özel alaşımli çelik
Special steel

KOD CODE	L mm	g		TL/Ad.
3554 14 0150	150	88	5	202,25

3552

Elektronikçi Yuvarlak Uçlu Kargaburun
Electronic Round Nose Pliers



Özel alaşımli çelik
Special steel

KOD CODE	L mm	g		TL/Ad.
3552 14 0125	125	78	5	202,85

3555

Elektronikçi Sivri Uçlu Düz Kargaburun
Electronic Needle Flat Nose Pliers



Özel alaşımli çelik
Special steel

KOD CODE	L mm	g		TL/Ad.
3555 14 0150	150	86	5	202,25

3556**Elektronikçi Sivri Uçlu Eğri Kargaburun**
Electronic Needle Bent Nose Pliers**Özel alaşımli çelik**
Special steel

KOD CODE	L mm	g	TL/Ad.
3556 14 0150	150	85	5 202,25

3557**Elektronikçi Pense**
Electronic Pliers**Özel alaşımli çelik**
Special steel

KOD CODE	L mm	g	TL/Ad.
3557 14 0125	125	80	5 202,85

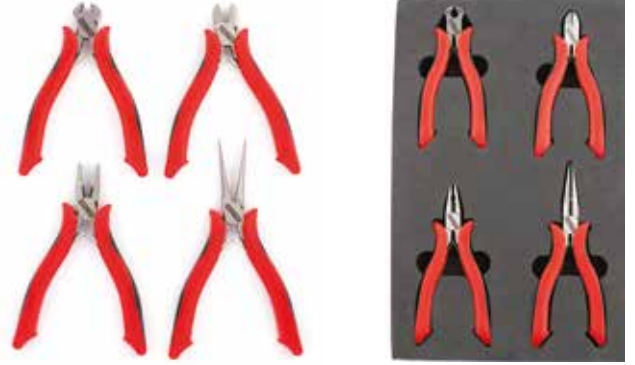
3560 00 2104**Elektronikçi Keski ve Pense Seti (4 Parça)**
Electronic Cutter & Pliers Set (4 Pcs)

KOD CODE	L mm	İÇERİK CONTENTS	TL Ad.
3550 14 0125	125	Elektronikçi Yan Keski Electronic Diagonal Side Cutting Pliers	1
3551 14 0125	125	Elektronikçi Tepe Keski Electronic End Cutting Pliers	1
3554 14 0150	150	Elektronikçi Uzun kargaburun Electronic Long Nose Pliers	1
3557 14 0125	125	Elektronikçi Pense Electronic Pliers	1
			838,35

3565 00 2104**Elektronikçi Kargaburun Seti (4 Parça)**
Electronic Long Nose Pliers Set (4 Pcs)

KOD CODE	L mm	İÇERİK CONTENTS	TL Ad.
3552 14 0125	125	Elektronikçi Yuvarlak Uçlu Kargaburun Electronic Round Nose Pliers	1
3553 14 0150	150	Elektronikçi Düz Uçlu Kargaburun Electronic Flat Nose Pliers	1
3555 14 0150	150	Elektronikçi Sivri Uçlu Düz Kargaburun Electronic Needle Nose Pliers	1
3556 14 0150	150	Elektronikçi Sivri Uçlu Eğri Kargaburun Electronic Bent Needle Nose Pliers	1
			809,60

(*) İşaretli olan ürünler stoklarla sınırlıdır.

3800

Kerpeten Carpenter Pincers

TS 60 - TS ISO 9243
DIN ISO 9243



Özel alaşımli çelik, Kesici ağızlar indüksiyonda sertleştirilmiş, PVC izoleli
Special steel, Cutters induction hardened, PVC insulated

KOD CODE	L mm	L inch	g	TL/Ad.
3800 15 0160	160	6 1/4"	220	5 161,60
3800 15 0180	180	7 1/8"	295	5 167,20
3800 15 0200	200	8"	330	5 222,95
3800 15 0250	250	10"	530	5 242,90

3830

Betoncu Kerpeteni Tower Pincers

TS 60 • TS ISO 9242
DIN ISO 9242



Özel alaşımli çelik, Kesici ağızlar indüksiyonda sertleştirilmiş, PVC izoleli
Special steel, Cutters induction hardened, PVC insulated

KOD CODE	L mm	L inch	g	TL/Ad.
3830 15 0225	225	9"	345	5 200,60
3830 15 0250	250	10"	395	5 221,65
3830 15 0280	280	11"	450	5 264,55

3831

Betoncu Kerpeteni Yaylı Tower Pincers with spring

TS 60 - TS ISO 9242
DIN ISO 9242



Özel alaşımli çelik, Kesici ağızlar indüksiyonda sertleştirilmiş, PVC izoleli
Special steel, Cutters induction hardened, PVC insulated

KOD CODE	L mm	L inch	g	TL/Ad.
3831 15 0280	280	11"	455	5 265,55

3835

Ağır Tip Betoncu Kerpeteni Heavy Tower Pincers

TS 60 - TS ISO 9242
DIN ISO 9242



İZELTAS YOUTUBE

Özel alaşımli çelik, Kesici ağızlar indüksiyonda sertleştirilmiş, PVC izoleli
Special steel, Cutters induction hardened, PVC insulated

KOD CODE	L mm	L inch	g	TL/Ad.
3835 15 0280	280	11"	400	5 263,20

3850

Danalya Shoemaker Pliers



Özel alaşımli çelik, İndüksiyonda sertleştirilmiş, Siyah Oksit kaplı
Special steel, Induction hardened, Black finish

KOD CODE	L mm	L inch	g	TL/Ad.
3850 12 0200	200	8"	360	5 326,75

(*) İşaretli olan ürünler stoklarla sınırlıdır.



1000V İZOLELİ ALETLER

1000V INSULATED TOOLS



İZELTAŞ YOUTUBE

VDE BELGELİ ÜRÜNLERİMİZ / VDE CERTIFIED PRODUCTS



- » El aletleri sektörünün lider markası İZELTAŞ'ın VDE belgeli ürünleri elektrik sektöründe fark yaratıyor.
- Bu ürünler elektrik sektöründe 1000V izolasyon sağlamak için özel olarak tasarlanmış yanmaz sapları ile kullanıcıya güven verir.
 - Elektrik akımının bulunduğu alanlarda güvenli kullanım sağlar.
 - Yanma, 1000V elektrik direnci, soğuk ve sıcak havalarda sap sökme deneyleri başta olmak üzere pek çok özel testten geçirilen ürünler, Alman VDE firmasından onaylıdır.
 - Ergonomik sap tasarımı ile tutuş ve kullanım kolaylığı sağlar.



- » As the leading brand in hand tools sector, CDE certified products of İZELTAŞ make a difference in electrical sector.
- These products assure the user with their handles specially designed to provide isolation up to 1000 V.
 - They provide safe use in areas with electrical current.
 - The products are certified by German VDE institution, being subjected to various tests particularly including fire resistance, 1000 V electrical resistance and handle detachment tests in hot and cold air conditions.
 - They provide ease of grip and use with an ergonomic design.



Çalışma sırasında nelere dikkat edilmelidir?

- Elektrik akımının var olduğu alanlarda yalnızca özel eğitilmiş ve alanında uzman kişiler çalışmalıdır.
- Her kullanım öncesinde VDE belgeli ürünlerde ve izolelerinde hasar olup olmadığını kontrol edilmelidir.
- VDE belgeli ürünler amacı dışında ya da birleştirilerek kullanılmamalıdır.
- VDE belgeli ürünler ile koruyucu ekipmanlarınızı da güvenlik amacıyla kullanmalısınız.



Important points for use

- Only specially trained and expert personnel should engage in work in areas with electrical current.
- Before each use VDE certified products and their isolation materials should be checked against damage.
- VDE certified products should not be used outside their purpose or in combination.
- Protective equipment should also be used to protect personnel in addition to VDE certified products.



**VDE belgeli ürünlerimiz,
ilgili uluslararası standartlara göre
kontrol edildikten sonra ek olarak
beş ayrı teste tabi tutulur**

**Our VDE certified products
are controlled in accord with the applicable
international standards and then are
subjected to five different tests:**

» 1- Voltaj Testi: 3 dakika boyunca 10.000V'a tabi tutulan izoleli el aletinde kaçak yada elektrik akımı atlama olmamalıdır.

» 1- Voltage Test: No residual current or electrical arc should be seen on the isolated hand tool subjected to 10,000 V for 3 minutes.

2- Soğuk Şoklama Testi : -24 derece 2 saat bekletilmiş (şoklanmış) el aletine 60-80 cm yükseklikten 600gr ağırlık ile darbeler uygulanır. İzolede kırılma ya da çatlama olmamalıdır.

2- Cold Shock Test: Hand tools left in -24 °C for 2 hours (shocked) are subjected to impacts with a 600 gr weight dropped from a height of 60-80 cm. No breakage or cracking should be seen on the isolation material.

3- Dayanıklılık Testi: +70 derece 1 hafta bekletilmiş el aletine 50kg yük ile sap sökme testi uygulanır. Sap yerinden çıkmamalıdır.

3- Durability Test: Hand tools left in +70 °C for 1 week are subjected to handle detachment test with a load of 50 kg. The handle should not detach.

4- Geçirgenlik Testi: 5000V elektrik akımına karşı 3 dakika boyunca 2kg sivri uçlu ağırlıkta baskı yapılarak elektrik verilir. Kaçak ya da elektrik atlama olmamalıdır.

4- Perviousness Test: Pointed tips under 2 kg load are used to apply 5000 V electrical current for 3 minutes. There should be no residual current or electrical arc.

5- Yanma Testi: Yüksek yoğunluktaki alev 20 saniye maruz bırakılarak teste tabi tutulur. Alevden uzaklaştırılan izole yanmaya devam etmemelidir.

5- Fire Test: The tool is subjected to high intensity flames for 20 seconds. After contact with the flame is ended the isolation material should not continue burning.



Güçlü kavrama sağlayan
tırnaklı tutma yüzeyleri
Toothed surface for strong grip

Isıl işlem sonrasında indüksiyonda
sertleştirme ile kullanım
ömrü artırılmış kesici ağızlar
Heat-treated and induction hardened cutting edges for long
lifetime

Nikel üzerine krom kaplama ile
korozyon direncinde
üst seviye koruma
High corrosion resistance
with chrome over nickel plating

Yüksek karbonlu
sıcak dövme çeliği
ile artırılmış
dayanım
High carbon forged steel for
improved durability

VDE/GS belgeli, 1000V dayanımlı,
sert plastikten ve konforlu tutuş
sağlayan yumuşak elastomer
malzemeden imal edilmiş
dayanımı yüksek çift
komponentli ergonomik sap
VDE/GS certified, insulated for 1000V
usage. Two component ergonomic
handle with high strength and
soft grip plastic



İZELTAS YOUTUBE

(★) İşaretili olan ürünler stoklarla sınırlıdır.

0255

Süper İzole Çatal Bir Ağız Anahtar (mm)
Single Ended Open Jaw Wrench
Super Insulated (mm)

IEC 60900
⚡ 1000 V



Krom vanadyum, Krom kaplı, Kalın PVC izoleli
Chrom vanadium, Chrom plated, Triple PVC insulated

KOD CODE	mm	L mm	g		TL/Ad.
0255 01 0010	10	110	40	10	76,75
0255 01 0011	11	120	45	10	81,05
0255 01 0012	12	130	50	10	84,65
0255 01 0013	13	140	60	10	91,10
0255 01 0014	14	155	75	10	94,55
0255 01 0017	17	170	100	10	116,05
0255 01 0019	19	185	150	10	136,20
0255 01 0022	22	200	200	10	183,20
0255 01 0024	24	220	280	10	224,15

0435

Süper İzoleli Yıldız Bir Ağız Anahtar (mm)
Single Ended Ring Wrench
Super Insulated (mm)

IEC 60900
⚡ 1000 V



Krom vanadyum, Krom kaplı, Kalın PVC izoleli
Chrom vanadium, Chrom plated, Triple PVC insulated

KOD CODE	mm	L mm	g		TL/Ad.
0435 03 0010	10	170	100	10	102,30
0435 03 0011	11	175	110	10	102,30
0435 03 0012	12	180	130	10	116,05
0435 03 0013	13	185	150	10	116,05
0435 03 0014	14	190	180	10	121,80
0435 03 0017	17	205	220	10	138,00
0435 03 0019	19	220	270	10	164,65
0435 03 0022	22	245	310	10	180,50
0435 03 0024	24	270	420	10	241,15

2400

1000V İzoleli Üniversal Fort Pense
Insulated Type Waterpump
Pliers Universal 1000V



TS 60
TS ISO 8976
IEC 60900
⚡ 1000 V



Krom vanadyum, Krom kaplı, çift komponent saplı
Chrom vanadium, Chrom plated, Two component handle

KOD CODE	L mm	L inch	mm	g		TL/Ad.
2400 11 6240	240	9 1/2"	35	370	5	293,15

3020

1000V İzoleli Elektrikçi Kombine Pense
Insulated Electrician Type
Combination Pliers 1000V



TS 60
TS ISO 5746
DIN ISO 5746

⚡ 1000 V
IEC 60900



Özel alaşımli çelik, Kesici ağızlar indüksiyonda sertleştirilmiş, Krom kaplı
Special steel, Cutters induction hardened, Chrom plated



KOD CODE	L mm	L inch	g		TL/Ad.
3020 12 6160	160	6 1/4"	205	5	216,25
3020 12 6180	180	7 1/8"	260	5	231,50
3020 12 6200	200	8"	345	5	261,35

(★) İşaretli olan ürünler stoklarla sınırlıdır.

1000V İzoleli Elektrikçi Kargaburun Düz Uçlu
Insulated Electrician Type Nose Pliers 1000V



TS 60
TS ISO 5745
DIN ISO 5745
⚡ 1000 V
IEC 60900



Özel alaşımlı çelik, Kesici ağızlar indüksiyonda sertleştirilmiş, Krom kaplı
Special steel, Cutters induction hardened, Chrom plated

KOD CODE	L mm	L inch	g	□	TL/Ad.
3220 13 6140	140	5 1/2"	110	5	221,25
3220 13 6160	160	6 1/4"	140	5	244,65
3220 13 6180	180	7 1/8"	160	5	274,60
3220 13 6200	200	8"	170	5	285,15

1000V İzoleli Elektrikçi Yan Keski
Insulated Electrician Type Side Cutter 1000V



TS 60
TS ISO 5749
DIN ISO 5749
⚡ 1000 V

IEC 60900



Özel alaşımlı çelik, Kesici ağızlar indüksiyonda sertleştirilmiş, Krom kaplı
Special steel, Cutters induction hardened, Chrom plated

KOD CODE	L mm	L inch	g	□	TL/Ad.
3700 16 6140	140	5 1/2"	165	5	248,00
3700 16 6160	160	6 1/4"	215	5	281,50
3700 16 6180	180	7 1/8"	225	5	314,95

1000V İzoleli Tek Ağızlı Kablo Kesici
Cable Cutter 1000V

⚡ 1000 V
IEC 60900



Özel alaşımlı çelik, Kesici ağızlar indüksiyonda sertleştirilmiş
Special steel, Cutters induction hardened

KOD CODE	L mm	L inch	g	□	TL/Ad.
3715 16 6165	165	6 1/4"	150	5	248,70

1000V İzoleli Elektrikçi Seti (3 Parça)
1000V Insulated Tool Set (3 Pcs)



KOD CODE	İÇERİK CONTENTS	□	TL/Ad.
3020 12 6160	160 mm 1000V İzoleli Elektrikçi Kombine Pense Insulated Electrician Type Combination Pliers	1	
3220 13 6160	160 mm 1000V İzoleli Elektrikçi Kargaburun Düz Uçlu Insulated Electrician Type Nose Pliers	1	742,40
3700 16 6160	160 mm 1000V İzoleli Elektrikçi Yan Keski Insulated Electrician Type Side Cutter	1	

(★) İşaretili olan ürünler stoklarla sınırlıdır.

4140

1000V İzoleli Elektrikçi Düz Uçlu Tornavida Insulated Electrician Type Flat Screwdriver 1000V

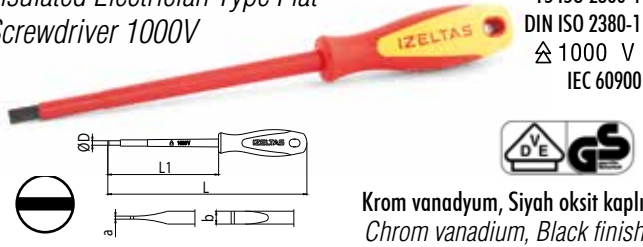

TS 59
TS ISO 2380-1
DIN ISO 2380-1
△ 1000 V
IEC 60900



Krom vanadyum, Siyah oksit kaplı
Chrom vanadium, Black finish

KOD CODE	ØDxL1 mm	⊖		L mm	g	□	TL/Ad.
		a mm	b mm				
4140 17 2575	2.5x75	0.4	2.5	150	25	10	35,40
4140 17 4100	4x100	0.8	4	185	40	10	41,55
4140 17 5512	5.5x125	1	5.5	220	70	10	54,75
4140 17 6515	6.5x150	1.2	6.5	245	90	10	61,20

4145

1000V İzoleli Elektrikçi Yıldız Uçlu Tornavida Insulated Electrician Type Phillips Screwdriver 1000V



TS 59
TS 59-5 ISO 8764
DIN ISO 8764
△ 1000 V
IEC 60900



Krom vanadyum, Siyah oksit kaplı
Chrom vanadium, Black finish

KOD CODE	ØDxL1 mm	⊕	L mm	g	□	TL/Ad.
4145 18 0360	3x60	Ph0	135	25	10	36,80
4145 18 4580	4.5x80	Ph1	165	45	10	52,00
4145 18 6100	6x100	Ph2	195	70	10	61,20

4140

1000V İzoleli Elektrikçi Tornavida Seti (6 Parça) Insulated Electrician Set (6 Pcs) Screwdriver 1000V



KOD CODE	İÇERİK CONTENTS	g	□	TL/Ad.
4140 00 9106	⊖	340	6	306,10
	2.5x75 - 4x100			
	5.5x125 - 6.5x150			
	Düz uçlu / Flat			
⊕	4.5x80 - 6x100			
	Yıldız uçlu / Phillips			

4773

1000V Süngüsü İzoleli Lokma Uçlu Tornavida Nut Spinner, Electrician Blade Insulated 1000V

DIN 3125

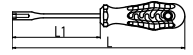

Krom vanadyum, iki komponent saplı
Chrome vanadium, Two component handle

KOD CODE	⊖ mm	L mm	L1 mm	g	□	TL/Ad.
4773 19 0040	4	220	125	90	10	115,25
4773 19 0050	5	220	125	90	10	115,25
4773 19 0055	5.5	220	125	90	10	115,25
4773 19 0060	6	220	125	90	10	115,25
4773 19 0070	7	230	125	110	10	123,55
4773 19 0080	8	230	125	120	10	123,55
4773 19 0090	9	230	125	125	10	133,45
4773 19 0100	10	230	125	125	10	133,45
4773 19 0110	11	230	125	140	10	145,70
4773 19 0120	12	230	125	145	10	156,30
4773 19 0130	13	230	125	150	10	168,40
4773 19 0140	14	230	125	150	10	186,20

4773

1000V Süngüsü İzoleli Lokma Uçlu Tornavida Takımı (8 Parça) Nut Spinner, Electrician Blade Insulated Set (8 Pcs) 1000V



KOD CODE	İÇERİK CONTENTS	g	□	TL/Ad.
4773 00 8108	6 - 7 - 8 - 9 - 10 - 11 - 12 - 13	2225	8	1099,65

(★) İşaretili olan ürünler stoklarla sınırlıdır.

1000V Sngs İzoleli Manyetik Bits Tutucu Tornavida
Screwdriver, Magnetic Bit Holder Insulated
1000V

⚡ 1000 V
IEC 60900



KOD CODE	Ø mm	L mm	L1 mm	g	TL/Ad.
4783 19 6120	6.3	230	120	115	10

8795 00 6005

1000V İzoleli Elektrikçi Seti (5 Parça)
1000V Insulated Tool Set (5 Pcs)



İZELTAS YOUTUBE

KOD CODE	İÇERİK CONTENTS	TL/Ad.
3020 12 6180	180 mm 1000V İzoleli Elektrikçi Kombine Pense Insulated Electrician Type Combination Pliers 1000V	1
3220 13 6200	200 mm 1000V İzoleli Elektrikçi Kargaburun Insulated Electrician Type Nose Pliers	1
3700 16 6160	160 mm 1000V İzoleli Elektrikçi Yan Keski Insulated Electrician Type Nose	1
4140 17 5512	5.5x125 1000V Elektrikçi Düz Uçlu Tornavida Insulated Electrician Type Flat Screwdriver 1000V	1
4145 18 6100	6x100 1000V İzoleli Elektrikçi Yıldız Uçlu Tornavida Insulated Electrician Type Phillips Screwdriver 1000V	1

8440 00 1023

19" Plastik Takım Çantası Elektrikçi Set (23 Parça)
Plastic Tool Box for Electrician 19" (23 Pcs)



KOD CODE	İÇERİK CONTENTS	TL/Ad.
8440 33 1019	19" Plastik Takım Çantası Plastic Tool Box	1
3700 16 6160	160 mm 1000V İzoleli Elektrikçi Yan Keski Insulated Electrician Type Side Cutter 1000V	1
3020 12 6180	180 mm 1000V İzoleli Elektrikçi Kombine Pense Insulated Electrician Type Combination Pliers 1000V	1
3220 13 6160	160 mm 1000V İzoleli Elektrikçi Kargaburun Düz Uçlu Insulated Electrician Type Nose Pliers 1000V	1
4773 19 0100	1000V Sngs İzoleli Lokma Uçlu Tornavida 10mm Nut Spinner, Electrician Blade Insulated 1000V	1
4773 19 0130	1000V Sngs İzoleli Lokma Uçlu Tornavida 13mm Nut Spinner, Electrician Blade Insulated 1000V	1
3715 16 6165	165mm 1000V İzoleli Elektrikçi Tek Ağız Kablo Kesici Cable Cutter 1000V	1
4520 18 0360	3x60 Klemens Yıldız Tornavida Electronic Screwdriver, Phillips	1
4520 18 0480	4x80 Klemens Yıldız Tornavida Electronic Screwdriver, Phillips	1
4500 17 0380	3x80 Klemens Düz Tornavida Electronic Screwdriver, Flat	1
4500 17 0480	4x80 Klemens Düz Tornavida Electronic Screwdriver, Flat	1
4140 17 4100	4x100 1000V İzoleli Elektrikçi Düz Tornavida Insulated Electrician Type Flat Screwdriver 1000V	1
4145 18 4580	4,5x80 1000V İzoleli Elektrikçi Yıldız Tornavida Insulated Electrician Type Phillips Screwdriver 1000V	1
4145 18 6100	6x100 1000V İzoleli Elektrikçi Yıldız Tornavida Insulated Electrician Type Phillips Screwdriver 1000V	1
4550 17 0190	190 mm Kontrol Kalem Voltage Tester Flat	1
4560 18 0190	190 mm Yıldız Kontrol Kalem Voltage Tester Phillips	1
4783 19 6120	6.3x120 1000V İzoleli Elektrikçi Manyetik Bits Tutucu Tornavida Screwdriver, Magnetic Bit Holder Insulated 1000V	1
4800 00 8106	6 lı Bits Set (25 mm) Bit Set 6 Pcs	6

(*) İşaretili olan ürünler stoklarla sınırlıdır.

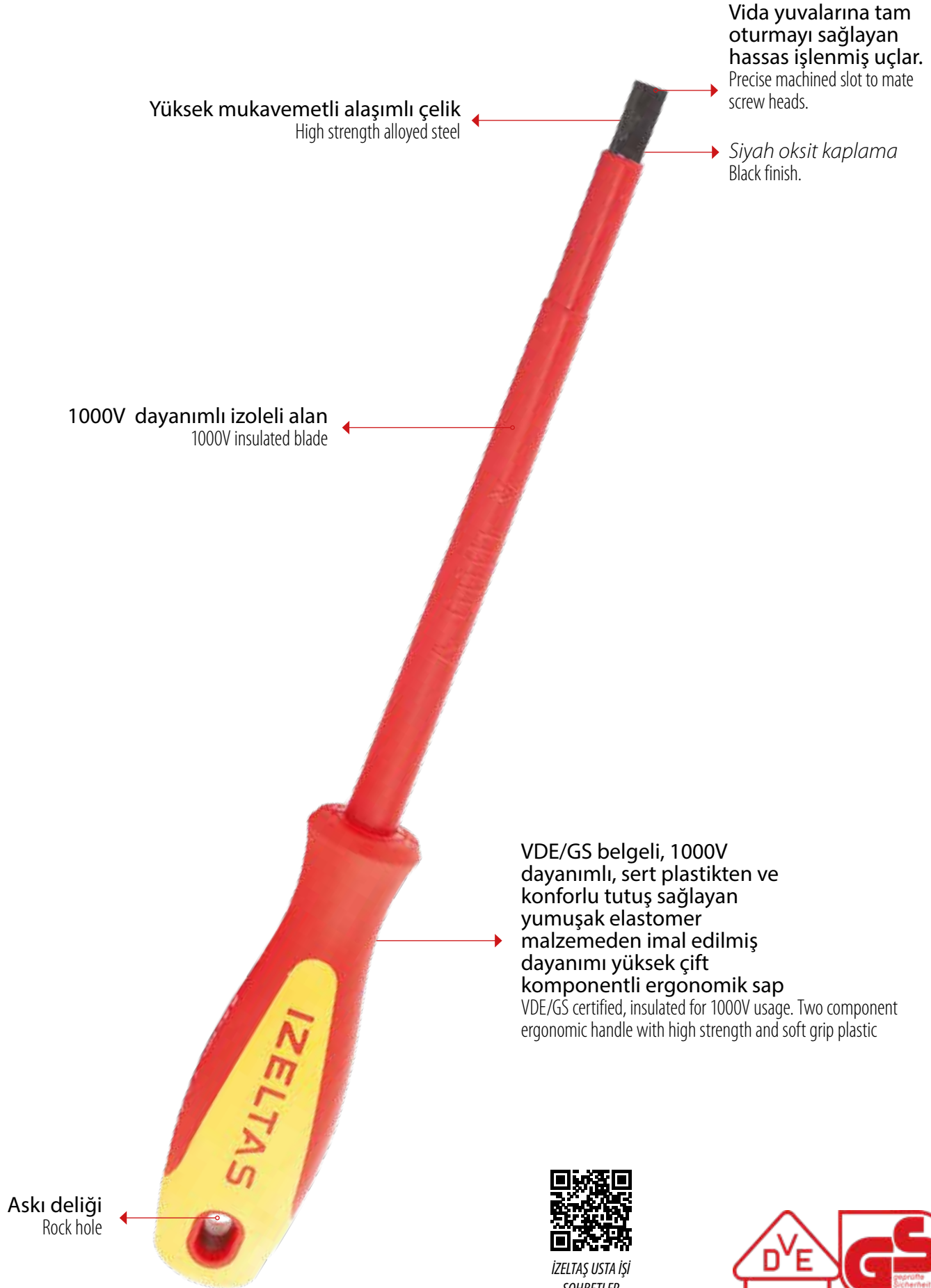
1000V ELEKTRİKÇİ DÜZ TORNAVİDA / INSULATED ELECTRICIAN TYPE PLAT SCREWDRIVER 1000V

Yüksek mukavemetli alaşımlı çelik
High strength alloyed steel

Vida yuvalarına tam oturmayı sağlayan hassas işlenmiş uçlar.
Precise machined slot to mate screw heads.

Siyah oksit kaplama
Black finish.

1000V dayanımlı izoleli alan
1000V insulated blade

VDE/GS belgeli, 1000V dayanımlı, sert plastikten ve konforlu tutuş sağlayan yumuşak elastomer malzemeden imal edilmiş dayanımı yüksek çift komponentli ergonomik sap
VDE/GS certified, insulated for 1000V usage. Two component ergonomic handle with high strength and soft grip plastic

Askı deliği
Rock hole



IZELTAS USTA İŞİ
SOHBETLER



(*) İşaretili olan ürünler stoklarla sınırlıdır.



İZELTAS®

TORNAVİDA VE ALLEN ANAHTARLAR

SCREWDRIVERS AND HEX KEY WRENCHES

Tornavidalar
Screwdrivers

Kontrol Kalemleri
Testers

Bits Uçlar ve Aparatları
Bits

Allen Anahtarlar
Hex Key Wrenches

SCREWDRIVERS, HEX KEY
WRENCHES

TORNAVİDALAR
ALLEN
ANAHTARLAR



İZELTAS YOUTUBE

ELEKTRİK KONTROL KALEMİ/VOLTAGE TESTER

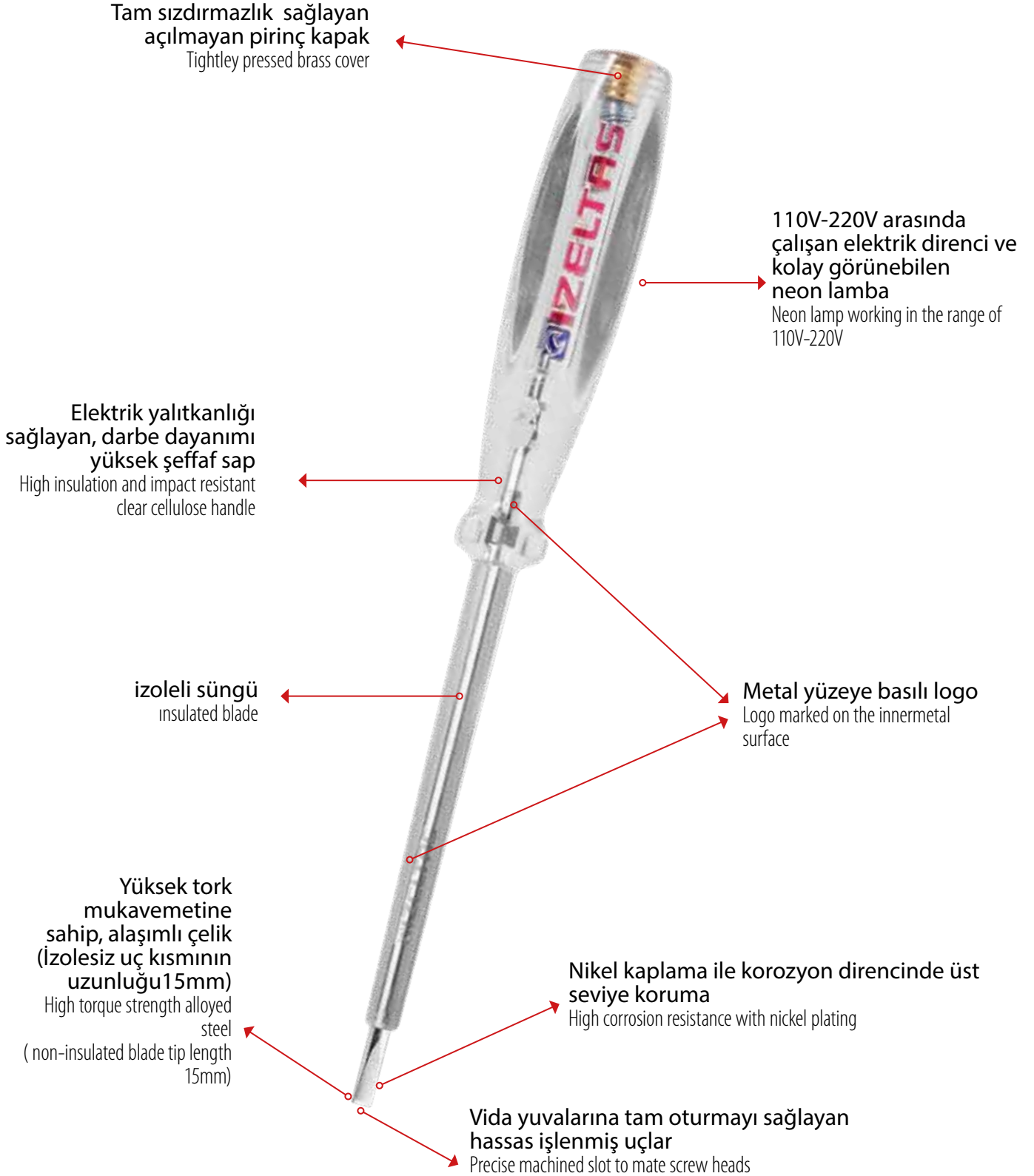

4550

Elektrik Kontrol Kalemi (Düz Uçlu)
Voltage Tester (Flat)

TS 13108

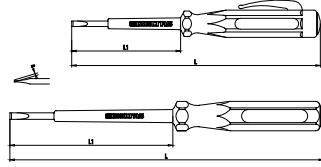

Krom vanadyum, Nikel kaplı,
Chrom vanadium, Nickel plated,

KOD CODE	L mm	⊖		L1 mm	g	TL/ Ad.	
		a mm	b mm				
4550 17 0135	135	0.5	3	60	20	10	32,95
4550 17 0190	190	0.8	4	100	40	10	41,55

4560

Elektrik Kontrol Kalemi (Yıldız Uçlu)
Voltage Tester Phillips

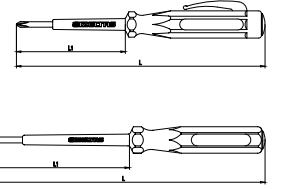

Krom vanadyum, Nikel kaplı
Chrom vanadium, Nickel plated

KOD CODE	L mm	L1 mm	+	g	TL/ Ad.	
						4560 18 0135
4560 18 0190	190	100	Ph0	40	10	49,90

4555

Master Kontrol Kalemi (Düz Uçlu)
Voltage Tester Master (Flat)

TS 13108

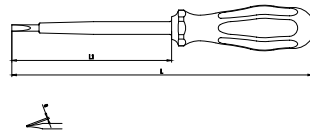

Krom vanadyum, Nikel kaplı
Chrom vanadium, Nickel plated.

KOD CODE	L mm	⊖		L1 mm	g	TL/ Ad.	
		a mm	b mm				
4555 17 0165	165	0.5	3.5	88	40	10	45,45

4565

Oto Kontrol Kalemi
Car Voltage Tester

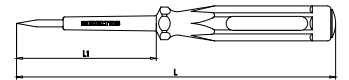

Krom vanadyum, Krom kaplı
Chrom vanadium, Chrom plated

Tüm otomobil ve ağır vasıta araçlarda 6-24V arası elektrik tesisatının kontrol edilmesinde kullanılır. Sivri uçlu olması sebebiyle kablo ve soketleri yerinden sökmeden kontrol kolaylığı sağlar.

Tool is used to control 6-24V electrical wiring in all cars and heavy duty vehicles. With its point tip, wires and sockets are not required to be disassembled.

KOD CODE	L mm	L1 mm	Kablo L (m)	g	TL/ Ad.	
						4565 17 0135

(★) İşaretli olan ürünler stoklarla sınırlıdır.

Kraft Seri Düz Uçlu Tornavida
Screwdriver, Kraft, Flat

 TS ISO 2380 - 1
 DIN ISO 2380-1

Krom vanadyum, Krom kaplı, Ucu siyah oksit, Selüloz asetat saplı
Chrom vanadium, Chrom plated and black tip, Cellulose acetate handle

KOD CODE	øDxL1 mm	⊖		L mm	g	□	TL/Ad.
		a mm	b mm				
4100 17 0340	3x40	0.5	3	105	20	10	27,50
4100 17 0380	3x80	0.5	3	155	35	10	29,25
4100 17 0480	4x80	0.8	4	165	50	10	31,60
4100 17 4100	4x100	0.8	4	185	50	10	36,60
4100 17 0580	5x80	1.0	5.5	175	70	10	38,70
4100 17 5100	5x100	1.0	5.5	195	75	10	42,65
4100 17 5125	5x125	1.0	5.5	220	80	10	48,70
4100 17 5150	5x150	1.0	5.5	245	80	10	53,15
4100 17 6100	6x100	1.2	6.5	195	85	10	43,70
4100 17 6125	6x125	1.2	6.5	220	90	10	50,05
4100 17 6150	6x150	1.2	6.5	245	95	10	54,95
4100 17 6175	6x175	1.2	6.5	270	100	10	70,55
4100 17 7125	7x125	1.2	8	230	120	10	55,75
4100 17 7150	7x150	1.2	8	255	130	10	64,35
4100 17 7175	7x175	1.2	8	280	135	10	73,85
4100 17 8150	8x150	1.6	10	255	145	10	73,20
4100 17 8175	8x175	1.6	10	280	150	10	78,00
4100 17 8200	8x200	1.6	10	305	160	10	95,50
4100 17 9200	9x200	2.0	12	305	190	10	101,85
4100 17 1125	11x250	2.5	14	365	305	10	129,45

Kraft Seri Düz Uçlu Tornavida Takımı (8 Parça)
Screwdriver, Flat, Kraft Set (8 Pcs)

KOD CODE	İÇERİK CONTENTS	g	□	TL/Ad.
4100 00 8108	3x80 - 4x80 - 4x100 5x100 - 5x125 - 6x100 6x125 - 6x150 ⊖ Düz uçlu / Flat	550	8	337,50

Kraft Seri Süngüsü Uzun Düz Uçlu Tornavida
Screwdriver, Kraft, Flat, Long

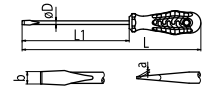
Krom vanadyum, Krom kaplı, Ucu siyah oksit, Selüloz asetat saplı
Chrom vanadium, Chrom plated and black tip, Cellulose acetate handle

KOD CODE	øDxL1 mm	⊖		L mm	g	□	TL/Ad.
		a mm	b mm				
4100 17 4300	4x300	0.8	4	385	70	10	90,10
4100 17 5250	5x250	1.0	5.5	345	95	10	100,70
4100 17 5350	5x350	1.0	5.5	445	115	10	113,75
4100 17 6350	6x350	1.2	6.5	445	125	10	120,45

(*) İşaretili olan ürünler stoklarla sınırlıdır.

4120

Kraft Seri Yıldız Uçlu Tornavida Screwdriver, Kraft, Phillips

TS 59 - 5 ISO 8764-1
DIN ISO 8764-1

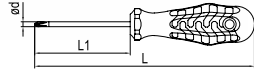

Krom vanadyum, Krom kaplı, Ucu siyah oksit, Selüloz asetat saplı
Chrom vanadium, Chrom plated and black tip,
Cellulose acetate handle.

KOD CODE	ØdxL1 mm	+	L mm	g	TL/Ad.
4120 18 0360	3x60	Ph0	135	30	10 30,95
4120 18 4580	4.5x80	Ph1	165	55	10 44,60
4120 18 5100	4.5x100	Ph1	185	55	10 49,75
4120 18 5150	4.5x150	Ph1	235	60	10 59,50
4120 18 6100	6x100	Ph2	195	85	10 53,70
4120 18 6150	6x150	Ph2	245	95	10 64,35
4120 18 6200	6x200	Ph2	295	105	10 83,60
4120 18 8150	8x150	Ph3	255	150	10 101,95
4120 18 1200	10x200	Ph4	315	240	10 157,75

4120

Kraft Seri Süngüsü Uzun Yıldız Uçlu Tornavida Screwdriver, Kraft, Phillips, Long

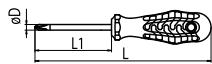

Krom vanadyum, Krom kaplı, Ucu siyah oksit, Selüloz asetat saplı
Chrom vanadium, Chrom plated and black tip,
Cellulose acetate handle

KOD CODE	ØDxL1 mm	+	L mm	g	TL/Ad.
4120 18 5300	4.5x300	Ph1	385	80	10 140,80
4120 18 6300	6x300	Ph2	395	125	10 145,60

4120

Kraft Seri Yıldız Uçlu Tornavida Takımı (6 parça) Screwdriver, Kraft, Phillips, Set (6 Pcs)



KOD CODE	İÇERİK CONTENTS	g	TL/Ad.
4120 00 8106	3x60 - 4.5x80 4.5x100 - 4.5x150 6x100 - 6x150 Yıldız uçlu / Phillips	380	6 302,85

4100

Kraft Seri Tornavida Seti (7 parça) Screwdriver Set, Kraft (7 Pcs)



KOD CODE	İÇERİK CONTENTS	g	TL/Ad.
4100 00 8107	3x80 - 4x80 - 4x100 5x125 - 6x150 Düz uçlu / Flat 4.5x80 - 6x100 Yıldız uçlu / Phillips	445	7 299,40

(*) İşaretli olan ürünler stoklarla sınırlıdır.

4110

Kraft Seri Düz Uçlu Topaç Tornavida
Screwdriver, Kraft, Stubby, Flat

TS 59

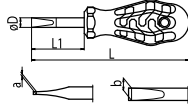

Krom vanadyum, Krom kaplı, Ucu siyah oksit, Selüloz asetat saplı
Chrom vanadium, Chrom plated and black tip,
Cellulose acetate handle

KOD CODE	øDxL1 mm	-		L mm	g	□	TL/Ad.
		a mm	b mm				
4110 17 5525	5.5x25	1	5.5	70	30	5	31,80
4110 17 5540	5.5x40	1	5.5	105	45	5	43,00
4110 17 6525	6.5x25	1.2	6.5	70	35	5	35,40
4110 17 6540	6.5x40	1.2	6.5	105	50	5	48,70

4130

Kraft Seri Yıldız Uçlu Topaç Tornavida
Screwdriver, Kraft, Stubby, Phillips

TS 59 -5

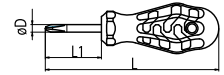

Krom vanadyum, Krom kaplı, Ucu siyah oksit, Selüloz asetat saplı
Chrom vanadium, Chrom plated and black tip,
Cellulose acetate handle

KOD CODE	øDxL1 mm	+	L mm	g	□	TL/Ad.
4130 18 4540	4.5x40	Ph1	105	40	5	42,80
4130 18 0625	6x25	Ph2	70	30	5	35,50
4130 18 0640	6x40	Ph2	105	50	5	48,10



4140

1000V İzoleli Elektrikçi Düz Uçlu Tornavida
Insulated Electrician Type Flat
Screwdriver 1000V

TS 59
TS ISO 2380-1
DIN ISO 2380-1
⚡ 1000 V
IEC 60900

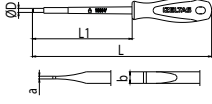

Krom vanadyum, Siyah oksit kaplı
Chrom vanadium, Black finish

KOD CODE	σDxL1 mm	⊖		L mm	g	□	TL/Ad.
		a mm	b mm				
4140 17 2575	2.5x75	0.4	2.5	150	25	10	35,40
4140 17 4100	4x100	0.8	4	185	40	10	41,55
4140 17 5512	5.5x125	1	5.5	220	70	10	54,75
4140 17 6515	6.5x150	1.2	6.5	245	90	10	61,20

4140

1000V İzoleli Elektrikçi Tornavida Seti (6 Parça)
Insulated Electrician Set (6 Pcs) Screwdriver 1000V



KOD CODE	İÇERİK CONTENTS	g	□	TL/Ad.
4140 00 9106	2.5x75 - 4x100	340	6	306,10
	⊖ 5.5x125 - 6.5x150			
	Düz uçlu / Flat			
	⊕ 4.5x80 - 6x100			
	Yıldız uçlu / Phillips			

4145

1000V İzoleli Elektrikçi Yıldız Uçlu Tornavida
Insulated Electrician Type Phillips
Screwdriver 1000V

TS 59
TS 59-5ISO 8764
DIN ISO 8764
⚡ 1000 V
IEC 60900

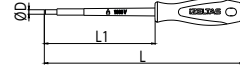

Krom vanadyum, Siyah oksit kaplı
Chrom vanadium, Black finish

KOD CODE	σDxL1 mm	⊕	L mm	g	□	TL/Ad.
4145 18 0360	3x60	Ph0	135	25	10	36,80
4145 18 4580	4.5x80	Ph1	165	45	10	52,00
4145 18 6100	6x100	Ph2	195	70	10	61,20



Opak Seri Düz Uçlu Tornavida
Screwdriver, Opak, Flat

 TS ISO 2380-1
 DIN ISO 2380-1

 Krom vanadyum, Krom kaplı, Ucu siyah oksit, PP saplı
Chrome vanadium, Chrom plated and black tip, PP handle

KOD CODE	øDxL1 mm	⊖		L mm	g	□	TL/Ad.
		a mm	b mm				
4300 17 0380	3x80	0.5	3	155	25	10	25,70
4300 17 0480	4x80	0.8	4	165	35	10	26,60
4300 17 4100	4x100	0.8	4	185	40	10	31,80
4300 17 5100	5x100	1.0	5.5	195	60	10	38,35
4300 17 5125	5x125	1.0	5.5	220	60	10	44,60
4300 17 6100	6x100	1.2	6.5	195	65	10	39,95
4300 17 6125	6x125	1.2	6.5	220	70	10	45,50
4300 17 6150	6x150	1.2	6.5	245	80	10	49,80
4300 17 7125	7x125	1.2	8	230	95	10	51,00
4300 17 7150	7x150	1.2	8	255	105	10	58,60
4300 17 8175	8x175	1.6	10	280	130	10	71,15
4300 17 9200	9x200	2.0	12	305	165	10	93,90

Opak Seri Yıldız Uçlu Tornavida
Screwdriver, Opak, Phillips

 TS 59 - 5 ISO 8764-1
 DIN ISO 8764

 Krom vanadyum, Krom kaplı, Ucu siyah oksit, PP saplı
Chrome vanadium, Chrom plated and black tip, PP handle

KOD CODE	øDxL1 mm	⊕	L mm	g	□	TL/Ad.
4320 18 4580	4.5x80	Ph1	165	40	10	40,50
4320 18 6100	6x100	Ph2	195	70	10	49,05
4320 18 8150	8x150	Ph3	255	140	10	92,95

Opak Seri Tornavida Seti (7 Parça)
Screwdriver Set, Opak (7 Pcs)

KOD CODE	İÇERİK CONTENTS	g	□	TL/Ad.
4300 00 8107	3x80 - 4x80 - 4x100	520	7	268,05
	⊖ 5x125 - 6x150			
	⊕ 4.5x80 - 6x100			
	Yıldız uçlu / Phillips			

Opak Seri Pozidriv Yıldız Uçlu Tornavida
Screwdriver, Opak, Pozidriv

DIN ISO 8764

 Krom vanadyum, Krom kaplı, Ucu siyah oksit, PP saplı
Chrome vanadium, Chrom plated and black tip, PP handle

KOD CODE	øDxL1 mm	⊕	L mm	g	□	TL/Ad.
4325 18 0360	3x60	Pz0	135	25	10	30,95
4325 18 4580	4.5x80	Pz1	165	40	10	44,60
4325 18 6100	6x100	Pz2	195	70	10	53,70
4325 18 8150	8x150	Pz3	255	140	10	101,95

(★) İşaretli olan ürünler stoklarla sınırlıdır.

★4350

Ergonomik Seri Düz Uçlu Tornavida Screwdriver, Ergonomic, Flat

TS ISO 2380-1
DIN ISO 2380-1

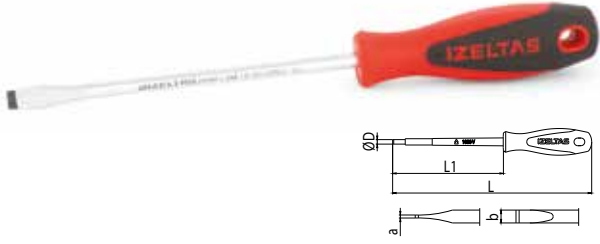

Krom vanadyum, Krom kaplı, Ucu siyah oksit, İki komponent saplı
Chrome vanadium, Chrom plated and black tip,
Two component handle.

KOD CODE	øDxL1 mm	-		L mm	g	TL/Ad.	
		a mm	b mm				
★4350 17 0380	3x80	0.5	3	155	25	10	31,80
★4350 17 0480	4x80	0.8	4	165	40	10	33,35
★4350 17 4100	4x100	0.8	4	185	40	10	38,00
★4350 17 5100	5x100	1.0	5.5	195	60	10	43,70
★4350 17 5125	5x125	1.0	5.5	220	65	10	50,45
★4350 17 6100	6x100	1.2	6.5	195	70	10	45,25
★4350 17 6125	6x125	1.2	6.5	220	75	10	51,85
★4350 17 6150	6x150	1.2	6.5	245	80	10	56,85
★4350 17 7125	7x125	1.2	8	230	100	10	57,95
★4350 17 7150	7x150	1.2	8	255	110	10	66,60
★4350 17 8175	8x175	1.6	10	280	140	10	80,75
★4350 17 9200	9x200	2	12	305	180	10	103,00

★4350

Ergonomik Seri Tornavida Seti (7 Parça) Screwdriver Set, Ergonomic (7 Pcs.)



KOD CODE	İÇERİK CONTENTS	g	TL/Ad.
★4350 00 8107	3x80 - 4x80 - 4x100	370	7
	5x125 - 6x150		
	Düz uçlu / Flat		
	4.5x80 - 6x100		
	Yıldız uçlu / Phillips		312,60

★4370

Ergonomik Seri Yıldız Uçlu Tornavida Screwdriver, Ergonomic, Phillips

TS 59 - 5 ISO 8764-1
DIN ISO 8764-1

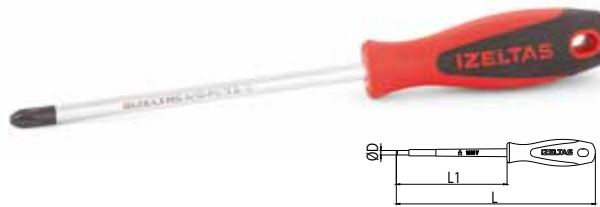

Krom vanadyum, Krom kaplı, Ucu siyah oksit, İki komponent saplı
Chrome vanadium, Chrom plated and black tip,
Two component handle

KOD CODE	øDxL1 mm	+	L mm	g	TL/Ad.	
★4370 18 0360	3x60	Ph0	135	25	10	32,35
★4370 18 4580	4.5x80	Ph1	165	45	10	46,15
★4370 18 6100	6x100	Ph2	195	70	10	56,00
★4370 18 8150	8x150	Ph3	255	130	10	105,45



(★) İşaretili olan ürünler stoklarla sınırlıdır.

4240

Değişken Uçlu Tornavida Screwdriver - Reversible

TSEK

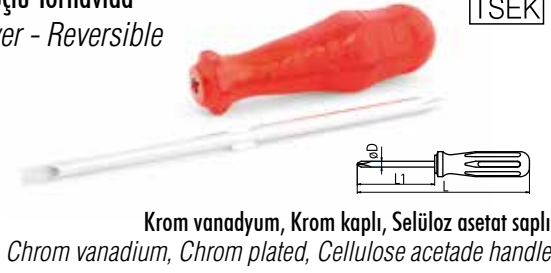

Krom vanadyum, Krom kaplı, Selüloz asetat saplı
Chrom vanadium, Chrom plated, Cellulose acetate handle

KOD CODE	øDxL1 mm	⊖ axb mm	⊕	L mm	g	TL/Ad.
4240 17 0680	6x80	1.2x6	Ph2	175	80	10, 56,20

4240

Değişken Uçlu Tornavida Takımı Screwdriver Set - Reversible

TSEK



KOD CODE	øDxL1 mm	⊖ axb mm	⊕	L mm	g	TL/Ad.
4240 00 7102	6x80	1.2x6	Ph2	175	105	1, 96,50
	4.5x80	0.65x4.5	Ph1			

4500

Elektronikçi Tip (Klemens) Düz Uçlu Tornavida Electronic Screwdriver, Flat



Krom vanadyum, Krom kaplı, Ucu siyah oksit, PP saplı
Chrome vanadium, Chrom plated and black tip, PP handle

KOD CODE	øDxL1 mm	⊖		L mm	g	TL/Ad.
		a mm	b mm			
4500 17 2560	2.5x60	0.4	2.5	140	15	10, 25,00
4500 17 2580	2.5x80	0.4	2.5	160	15	10, 26,15
4500 17 0380	3x80	0.5	3	160	15	10, 27,70
4500 17 3100	3x100	0.5	3	180	20	10, 33,80
4500 17 3125	3x125	0.5	3	205	20	10, 44,60
4500 17 3510	3.5x100	0.6	3.5	180	20	10, 34,95
4500 17 0480	4x80	0.8	4	160	20	10, 28,45
4500 17 4100	4x100	0.8	4	180	20	10, 34,95
4500 17 4125	4x125	0.8	4	205	25	10, 46,90
4500 17 4150	4x150	0.8	4	230	25	10, 51,10

4520

Elektronikçi Tip (Klemens) Yıldız Uçlu Tornavida Electronic Screwdriver, Phillips



Krom vanadyum, Krom kaplı, Ucu siyah oksit, PP saplı
Chrome vanadium, Chrom plated and black tip, PP handle

KOD CODE	øDxL1 mm	⊕	L mm	g	TL/Ad.
4520 18 0360	3x60	Ph0	140	15	10, 29,25
4520 18 0480	4x80	Ph0	160	20	10, 42,00
4520 18 4150	4x150	Ph0	230	25	10, 56,10

4500

Elektronikçi Tip (Klemens) Tornavida Seti (6 Parça) Electronic Screwdriver Set (6 Pcs)



KOD CODE	İÇERİK CONTENTS	g	TL/Ad.
4500 00 8106	3x80 - 3x100	115	6, 228,45
	3x125 - 4x150		
	Düz uçlu / Flat		
4500 00 8106	3x60 - 4x80	115	6, 228,45
	Yıldız uçlu / Phillips		

(*) İşaretli olan ürünler stoklarla sınırlıdır.

4530

Elektronikçi Tip (Klemens) Torx® Uçlu Tornavida Electronic Screwdriver, Torx®

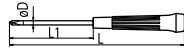

Krom vanadyum, Krom kaplı, Ucu siyah oksit, PP saplı
Chrom vanadium, Chrom plated and black tip, PP handle

KOD CODE	ØDxL1 mm	★	L mm	g	TL/Ad.
4530 17 0560	2.5x60	T5	145	15	10 33,80
4530 17 0660	2.5x60	T6	145	15	10 33,80
4530 17 0760	3x60	T7	145	15	10 35,00
4530 17 0860	3x60	T8	145	20	10 35,00
4530 17 0960	3x60	T9	145	20	10 35,00
4530 17 1060	3.5x60	T10	145	20	10 35,00

4530

Elektronikçi Tip (Klemens) Torx® Uçlu Tornavida Takımı (6 Parça) Electronic Screwdriver Set Torx (6 Pcs)



KOD CODE	İÇERİK CONTENTS	g	TL/Ad.
4530 00 1006	T5 - T6 - T7 - T8 - T9 - T10	115	6 207,60

4540

Klips Sökme Tornavidası Hupcap and Clip Remover

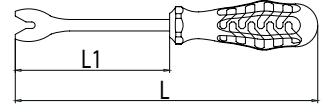

Krom vanadyum, Krom kaplı, PP Saplı
Chrom vanadium, Chrom plated, PP insulated

KOD CODE	L mm	L1	g	TL/Ad.
4540 19 0190	290	180	160	10 132,20

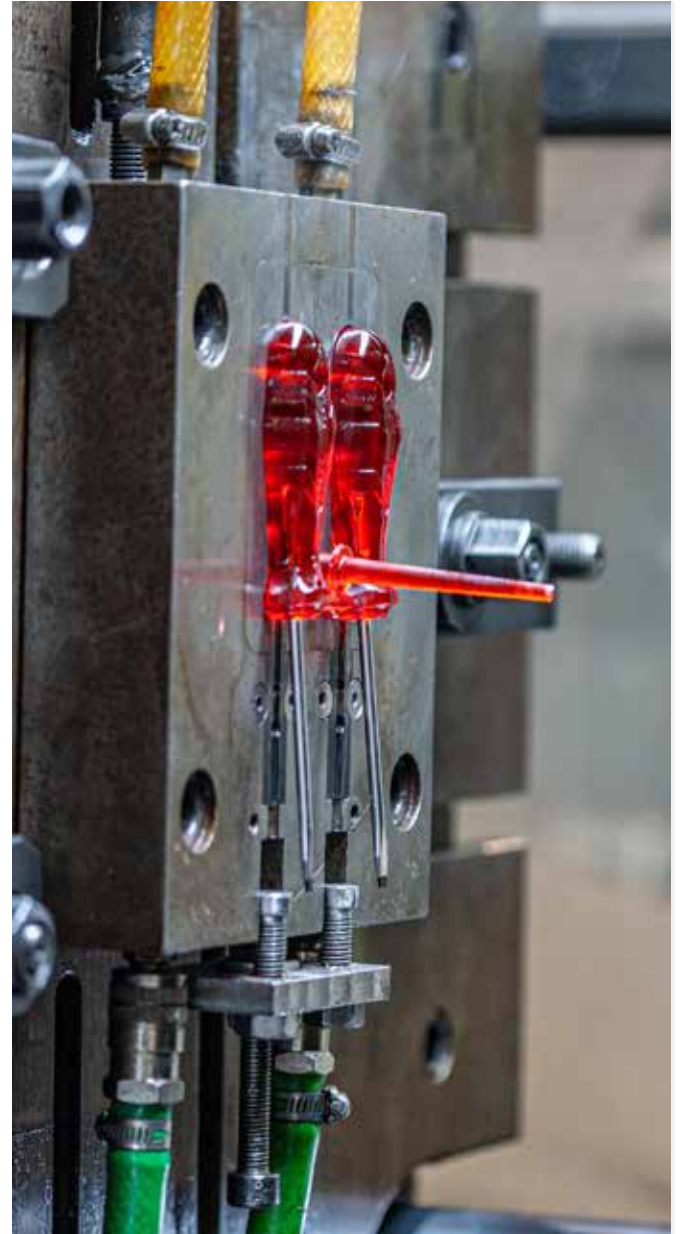

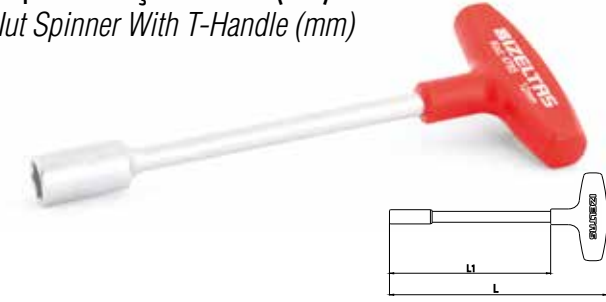
T Tipi Lokma Uçlu Tornavida (mm)
Nut Spinner With T-Handle (mm)

Krom vanadyum, Krom kaplı, PP Saplı
Chrom vanadium, Chrom plated, PP insulated

KOD CODE	mm	L mm	L1 mm	g		TL/Ad.
4765 19 0040	4	185	135	75	10	71,45
4765 19 0050	5	185	135	75	10	71,45
4765 19 0055	5.5	185	135	75	10	71,45
4765 19 0060	6	185	135	75	10	71,45
4765 19 0070	7	185	135	90	10	76,20
4765 19 0080	8	185	135	95	10	76,20
4765 19 0090	9	185	135	100	10	84,45
4765 19 0100	10	185	135	100	10	84,45
4765 19 0110	11	185	135	110	10	93,45
4765 19 0120	12	185	135	110	10	96,50
4765 19 0130	13	185	135	115	10	100,90
4765 19 0140	14	185	135	115	10	117,35

Lokma Uçlu Tornavida (mm)
Nut Spinner (mm)

DIN 3125



Krom vanadyum, Krom kaplı, PP Saplı
Chrom vanadium, Chrom plated, PP insulated

KOD CODE	mm	L mm	L1 mm	g		TL/Ad.
4770 19 0040	4	220	125	80	10	81,25
4770 19 0050	5	220	125	80	10	81,25
4770 19 0055	5.5	220	125	80	10	81,25
4770 19 0060	6	220	125	80	10	81,25
4770 19 0070	7	230	125	100	10	87,25
4770 19 0080	8	230	125	110	10	87,25
4770 19 0090	9	230	125	115	10	94,15
4770 19 0100	10	230	125	115	10	94,15
4770 19 0110	11	230	125	130	10	102,80
4770 19 0120	12	230	125	135	10	110,30
4770 19 0130	13	230	125	140	10	118,75
4770 19 0140	14	230	125	140	10	131,35

Lokma Uçlu Tornavida Takımı (8 Parça, mm)
Nut Spinner Set (8 Pcs, mm)



KOD CODE	İÇERİK CONTENTS	g		TL/Ad.
4770 00 8108	6 - 7 - 8 - 9 - 10 11 - 12 - 13	2145	8	775,90

(★) İşaretili olan ürünler stoklarla sınırlıdır.

4773

1000V Sngs İzoleli Lokma Uçlu Tornavida
Nut Spinner, Electrician Blade Insulated 1000V

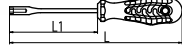
DIN 3125



Krom vanadyum, İki Komponent Saplı
Chrome vanadium, Two Component Insulated

KOD CODE	Ø mm	L mm	L1 mm	g	TL/Ad.	
4773 19 0040	4	220	125	90	10	115,25
4773 19 0050	5	220	125	90	10	115,25
4773 19 0055	5.5	220	125	90	10	115,25
4773 19 0060	6	220	125	90	10	115,25
4773 19 0070	7	230	125	110	10	123,55
4773 19 0080	8	230	125	120	10	123,55
4773 19 0090	9	230	125	125	10	133,45
4773 19 0100	10	230	125	125	10	133,45
4773 19 0110	11	230	125	140	10	145,70
4773 19 0120	12	230	125	145	10	156,30
4773 19 0130	13	230	125	150	10	168,40
4773 19 0140	14	230	125	150	10	186,20

4773

1000V Sngs İzoleli Lokma Uçlu Tornavida Takımı (8 Parça)
Nut Spinner, Electrician Blade Insulated Set (8 Pcs)
1000V



KOD CODE	İÇERİK CONTENTS	g	TL/Ad.	
4773 00 8108	6 - 7 - 8 - 9 - 10 - 11 - 12 - 13	2225	8	1099,65

4775

Torx® Uçlu Tornavida
Torx® Screwdriver

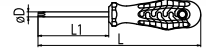

Krom vanadyum, Krom kaplı, Ucu siyah oksit, PP saplı
Chrome vanadium, Chrom plated and blackened, PP handle

KOD CODE	ØDxL1 mm	TL	L mm	g	TL/Ad.	
4775 18 0010	4x80	T10	165	35	10	40,25
4775 18 0015	4x80	T15	165	35	10	40,25
4775 18 0020	4x100	T20	185	40	10	44,65
4775 18 0025	4.5x100	T25	185	40	10	51,75
4775 18 0027	5x125	T27	220	60	10	57,15
4775 18 0030	6x125	T30	220	70	10	60,65
4775 18 0040	7x125	T40	230	100	10	75,35
4775 18 0045	8x125	T45	230	120	10	85,15

4775

Torx® Uçlu Tornavida Takımı (7 Parça)
Torx® Screwdriver Set (7 Pcs)



KOD CODE	İÇERİK CONTENTS	g	TL/Ad.	
4775 00 8107	T10 - T15 - T20 - T25 - T27 - T30 - T40	380	7	370,05

(*) İşaretili olan rnler stoklarla sınırlıdır.

4776

Delikli Torx® Uçlu Tornavida
Torx® Screwdriver / Tamper Resistance

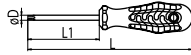

Krom vanadyum, Krom kaplı, Ucu siyah oksit, PP saplı
Chrome vanadium, Chrom plated and blackened, PP handle

KOD CODE	øDxL1 mm	☆	L mm	g	□	TL/Ad.
4776 18 0009	4x60	TR9	145	35	10	52,35
4776 18 0010	4x80	TR10	165	35	10	54,10
4776 18 0015	4x80	TR15	165	40	10	54,10
4776 18 0020	4x100	TR20	185	40	10	60,40
4776 18 0025	4.5x100	TR25	185	45	10	69,65
4776 18 0027	5x125	TR27	220	60	10	76,85
4776 18 0030	6x125	TR30	220	70	10	81,65
4776 18 0040	7x125	TR40	230	100	10	101,25

4776

Delikli Torx® Uçlu Tornavida Takımı (7 Parça)
Torx® Screwdriver / Tamper Resistance Set (7 Pcs)



KOD CODE	İÇERİK CONTENTS	g	□	TL/Ad.
4776 00 8107	TR10 - TR15 - TR20 - TR25 - TR27 TR30 - TR40	380	7	498,00

4780

Manyetik Bits Tutucu Tornavida (Uzun)
Screwdriver, Magnetic Bit Holder (Long)



KOD CODE	mm	L mm	L1 mm	g	□	TL/Ad.
4780 19 6120	6.3	230	120	105	10	104,85

4783

1000V Süngüsü İzoleli Manyetik Bits Tutucu Tornavida
Screwdriver, Magnetic Bit Holder Insulated
1000V

⚡ 1000 V
IEC 60900



KOD CODE	mm	L mm	L1 mm	g	□	TL/Ad.
4783 19 6120	6.3	230	120	115	10	129,55

4785

Manyetik Bits Tutucu Tornavida (Kısa)
Screwdriver, Magnetic Bit Holder, (Short)



KOD CODE	mm	L mm	L1 mm	g	□	TL/Ad.
4785 19 6330	6.3	130	30	60	10	57,05

4790

Üniversal Bits Adaptörü (Manyetik)
Screwdriver Universal Bit Holder (Magnetic)



KOD CODE	mm	mm	L mm	g	□	TL/Ad.
4790 26 6360	6.3	6.3	60	25	10	50,00

(★) İşaretili olan ürünler stoklarla sınırlıdır.

4795

T Tipi Manyetik Bits Tutucu Tornavida
Magnetic Bit Holder With T-Handle



KOD CODE	mm	L mm	L1 mm	g		TL/Ad.
4795 19 0010	6.3	180	130	60	10	110,85

4788

Manyetik Bits Tutucu Tornavida, Flexible
Screwdriver, Magnetic Bit Holder, Flexible



KOD CODE	mm	L mm	L1 mm	g		TL/Ad.
4788 19 6160	6.3	285	175	130	10	217,35

4805

Bits Uç Lokma Adaptörü (Makine Kullanımına Uygun)
Socket Adapter



KOD CODE		L mm	g		TL/Ad.
4805 20 5010	1/4"M - 1/4"M	50	20	10	17,95
4805 20 5011	1/4"M - 1/2"M	50	25	10	36,50

4815

Değişken Bits Uçlu Tornavida Set (7 parça)
Screwdriver - Interchangeable Bits Set (7 pcs)



KOD CODE	İÇERİK CONTENTS	g		TL/Ad.
4815 00 6107	100mm Sap Ph1x4.5 - Ph2x5.5 - Ph3x7 Pz1x4.5 - Pz2x5.5 - Pz3x7	140	7	120,60

4800

6'lı Bits Set
Bit Set (6 Pcs)



KOD CODE	İÇERİK CONTENTS	g		TL/Ad.
4800 00 8106	0.6x4.5 - 0.8x5.5	50	6	40,65
	Ph1 - Ph2 - Ph3			
	T27			

4800

10'lu Bits Set
Bit Set (10 Pcs)



KOD CODE	İÇERİK CONTENTS	g		TL/Ad.
4800 00 8110	0.6x4.5 - 0.8x5.5 1.2x6.5	55	10	75,30
	Ph1 - Ph2 - Ph3			
	T25 - T27 - T30 - T40			

4800

31'li Bits Set (Plastik Kutulu)
Bit Set In Plastic Case
(31 Pcs)



KOD CODE	İÇERİK CONTENTS	g		TL/Ad.
4800 00 8131	0.6x4.5 - 0.8x5.5	385	6 - 6	253,25
	1.2x6.5			
	Ph1			
	Ph2 - Ph3			
	T27			
	T25 - T30 - T40			
	6.3 x 60 Adaptör			

(*) İşaretli olan ürünler stoklarla sınırlıdır.

4810-4860

Düz Bits Uçlar

Bits Flat

25mm-50mm-75mm-100mm-150mm



Krom vanadyum
Chrom vanadium

KOD CODE	⊖	L mm	g	□	TL/Ad.
4810 20 0645	0.6x4.5	25	5	10	5,85
4810 20 0855	0.8x5.5	25	5	10	5,85
4810 20 1265	1.2x6.5	25	5	10	5,85
4810 20 5645	0.6x4.5	50	10	10	9,85
4810 20 5855	0.8x5.5	50	10	10	9,85
4810 20 5265	1.2x6.5	50	10	10	9,85
4860 20 0745	0.6x4.5	75	11	10	15,00
4860 20 0755	0.8x5.5	75	13	10	15,00
4860 20 0765	1.2x6.5	75	15	10	15,00
4860 20 1045	0.6x4.5	100	14	10	22,40
4860 20 1055	0.8x5.5	100	17	10	22,40
4860 20 1065	1.2x6.5	100	18	10	22,40
4860 20 1545	0.6x4.5	150	21	10	32,10
4860 20 1555	0.8x5.5	150	26	10	32,10
4860 20 1565	1.2x6.5	150	28	10	32,10

4820-4870

Yıldız Bits Uçlar

Bits Phillips

25mm-50mm-75mm-100mm-150mm



Krom vanadyum
Chrom vanadium

KOD CODE	⊕	L mm	g	□	TL/Ad.
4820 21 0001	Ph1	25	5	10	6,45
4820 21 0002	Ph2	25	5	10	6,45
4820 21 0003	Ph3	25	5	10	6,45
4820 21 0011	Ph1	50	10	10	11,45
4820 21 0012	Ph2	50	10	10	11,45
4820 21 0013	Ph3	50	10	10	11,45
4870 21 0701	Ph1	75	17	10	15,55
4870 21 0702	Ph2	75	18	10	15,55
4870 21 0703	Ph3	75	18	10	15,55
4870 21 1001	Ph1	100	20	10	23,80
4870 21 1002	Ph2	100	24	10	23,80
4870 21 1003	Ph3	100	24	10	23,80
4870 21 1501	Ph1	150	23	10	33,70
4870 21 1502	Ph2	150	33	10	33,70
4870 21 1503	Ph3	150	33	10	33,70

4810

Düz Bits Takımı (25 mm)

Flat Bit Set (25 mm)



KOD CODE	⊖	g	□	TL/Ad.
4810 00 0645	06x4.5	45	10	58,50
4810 00 0855	0.8x5.5	50	10	58,50
4810 00 1265	1.2x6.5	55	10	58,50

4820

Yıldız Bits Takımı (25 mm)

Phillips Bit Set (25 mm)



KOD CODE	⊕	g	□	TL/Ad.
4820 00 0001	Ph1	50	10	64,50
4820 00 0002	Ph2	50	10	64,50
4820 00 0003	Ph3	55	10	64,50

(★) İşaretili olan ürünler stoklarla sınırlıdır.

4825-4880

Pozidriv Bits Uçlar Bits Pozidriv

25mm-50mm-75mm-100mm-150mm



Krom vanadyum
Chrom vanadium

KOD CODE	+	L mm	g	TL/Ad.	
4825 21 0001	Pz1	25	5	10	6,95
4825 21 0002	Pz2	25	5	10	6,95
4825 21 0003	Pz3	25	5	10	6,95
4825 21 0011	Pz1	50	10	10	12,10
4825 21 0012	Pz2	50	10	10	12,10
4825 21 0013	Pz3	50	10	10	12,10
4880 21 0701	Pz1	75	17	10	15,80
4880 21 0702	Pz2	75	18	10	15,80
4880 21 0703	Pz3	75	18	10	15,80
4880 21 1001	Pz1	100	20	10	24,00
4880 21 1002	Pz2	100	24	10	24,00
4880 21 1003	Pz3	100	24	10	24,00
4880 21 1501	Pz1	150	23	10	34,45
4880 21 1502	Pz2	150	33	10	34,45
4880 21 1503	Pz3	150	33	10	34,45

4830-4885

Torx® Bits Uçlar Bits Torx®

25mm-50mm-75mm-100mm-150mm



Krom vanadyum
Chrom vanadium

KOD CODE	*	L mm	g	TL/Ad.	
4830 21 0025	T25	25	5	10	9,60
4830 21 0027	T27	25	5	10	9,60
4830 21 0030	T30	25	5	10	9,60
4830 21 0040	T40	25	5	10	9,60
4830 21 0125	T25	50	10	10	12,10
4830 21 0127	T27	50	10	10	12,10
4830 21 0130	T30	50	10	10	12,10
4830 21 0140	T40	50	10	10	12,10
4885 21 0725	T25	75	12	10	16,90
4885 21 0727	T27	75	15	10	16,90
4885 21 0730	T30	75	15	10	16,90
4885 21 0740	T40	75	17	10	16,90
4885 21 1025	T25	100	15	10	24,45
4885 21 1027	T27	100	20	10	24,45
4885 21 1030	T30	100	20	10	24,45
4885 21 1040	T40	100	23	10	24,45
4885 21 1525	T25	150	20	10	35,00
4885 21 1527	T27	150	25	10	35,00
4885 21 1530	T30	150	25	10	35,00
4885 21 1540	T40	150	33	10	35,00

4825

Pozidriv Bits Takımı (25 mm) Pozidriv Bit Set (25 mm)



KOD CODE	+	g	TL/Ad.	
4825 00 0001	Pz1	50	10	69,50
4825 00 0002	Pz2	55	10	69,50
4825 00 0003	Pz3	55	10	69,50

4830

Torx® Bits Takımı (25 mm) Torx® Bit Set (25 mm)



KOD CODE	*	g	TL/Ad.	
4830 00 0025	T25	50	10	96,00
4830 00 0027	T27	50	10	96,00
4830 00 0030	T30	55	10	96,00
4830 00 0040	T40	60	10	96,00

(*) İşaretli olan ürünler stoklarla sınırlıdır.

4784

1/4"Avuç İçi Bits Tutucu
Palm Ratchet Bit Holder



**YENİ
NEW**

KOD CODE	Ø	L mm	g	TL/Ad.
4784 19 6346	46	26,5	100	5 202,05

4850

100mm Uzun Bits Uç Takımı (13 Parça)
Bit Set, Long Type 100 mm (13 Pcs)

100mm

KOD CODE	İÇERİK CONTENTS	g	TL/Ad.
4850 00 1013	Düz Uçlar Flat Bits 0.6x4.5 - 0.8x 5.5 1.2x6.5	263	13 308,40
	Yıldız Uçlar Phillips Bits Ph1 - Ph2 - Ph3		
	Pozidriv Uçlar Pozidriv Bits Pz1 - Pz2 - Pz3		
	Torx® Uçlar Torx® Bits T25 - T27 -T30 - T40		

4850

75mm Uzun Bits Uç Takımı (13 Parça)
Bit Set, Long Type 75 mm (13 Pcs)

75mm

KOD CODE	İÇERİK CONTENTS	g	TL/Ad.
4850 00 0713	Düz Uçlar Flat Bits 0.6x4.5 - 0.8x 5.5 1.2x6.5	204	13 206,65
	Yıldız Uçlar Phillips Bits Ph1 - Ph2 - Ph3		
	Pozidriv Uçlar Pozidriv Bits Pz1 - Pz2 - Pz3		
	Torx® Uçlar Torx® Bits T25 - T27 T30 - T40		

4850

150mm Uzun Bits Uç Takımı (13 Parça)
Bit Set, Long Type 150 mm (13 Pcs)

150mm

KOD CODE	İÇERİK CONTENTS	g	TL/Ad.
4850 00 1513	Düz Uçlar Flat Bits 0.6x4.5 - 0.8x 5.5 1.2x6.5	356	13 440,75
	Yıldız Uçlar Phillips Bits Ph1 - Ph2 - Ph3		
	Pozidriv Uçlar Pozidriv Bits Pz1 - Pz2 - Pz3		
	Torx® Uçlar Torx® Bits T25 - T27 - T30 - T40		

(★) İşaretli olan ürünler stoklarla sınırlıdır.

4900

Allen Anahtar Altı Köşe (mm) Hex Key Wrench (mm)

TS ISO 2936
DIN ISO 2936

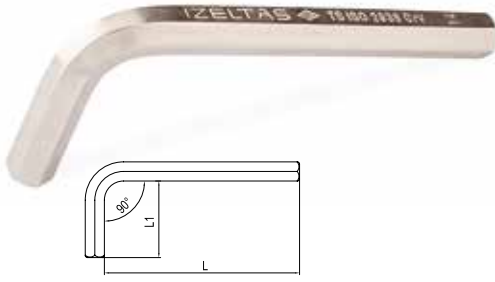

Krom Vanadyum, Nikel Kaplı
Chrom Vanadium, Nickel Plated

KOD CODE	mm	L mm	L1 mm	g	TL/Ad.	
4900 22 0015	1.5	45	14	1.5	10	3,45
4900 22 0020	2	50	16	2	10	5,05
4900 22 0025	2.5	56	18	4	10	6,15
4900 22 0030	3	63	20	6	10	6,80
4900 22 0035	3.5	66	22	8	10	8,40
4900 22 0040	4	70	25	10	10	8,60
4900 22 0050	5	80	28	20	10	10,00
4900 22 0060	6	90	32	30	10	13,20
4900 22 0070	7	95	34	40	10	19,50
4900 22 0080	8	100	36	55	10	22,45
4900 22 0090	9	105	38	75	10	27,65
4900 22 0100	10	112	40	100	10	34,15
4900 22 0120	12	125	45	160	10	49,65
4900 22 0140	14	140	56	250	5	79,20
4900 22 0160	16	152	60	375	5	146,30
4900 22 0170	17	160	63	425	5	157,75
4900 22 0190	19	180	70	610	5	195,05
4900 22 0220	22	200	80	940	5	325,65
4900 22 0240	24	224	90	1250	5	439,60

4900

Allen Anahtar Takım Altı Köşe (mm) Hex Key Wrench Set (mm)



KOD CODE	İÇERİK CONTENTS	g	TL/Ad.	
4900 00 3110	2 - 2.5 - 3 - 4 - 5 - 6 7 - 8 - 9 - 10	400	10	153,55
4900 00 3112	2 - 2.5 - 3 - 3.5 - 4 - 5 6 - 7 - 8 - 9 - 10 - 12	565	12	211,60

4901

Allen Anahtar Altı Köşe (SAE) Hex Key Wrench (SAE)

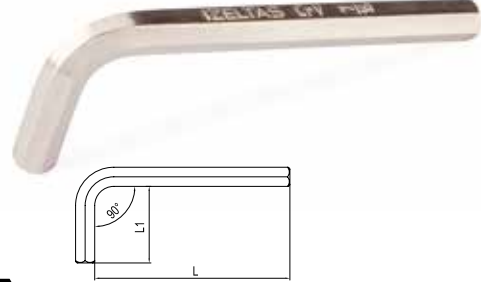

Krom Vanadyum, Nikel Kaplı
Chrom Vanadium, Nickel Plated

KOD CODE	inch	L mm	L1 mm	g	TL/Ad.	
4901 22 1984	5/64"	50	16	2	10	6.70
4901 22 2381	3/32"	54	18	4	10	7,30
4901 22 3125	1/8"	58	20	5	10	8,80
4901 22 3968	5/32"	62	22	10	10	10,75
4901 22 4762	3/16"	68	24	15	10	11,05
4901 22 5556	7/32"	74	26	25	10	14,80
4901 22 6350	1/4"	82	28	35	10	18,05
4901 22 7937	5/16"	94	32	55	10	22,45
4901 22 9825	3/8"	106	38	90	10	30,95
4901 22 1111	7/16"	118	42	130	10	41,65
4901 22 1270	1/2"	132	46	190	10	52,55
4901 22 1428	9/16"	144	52	265	10	76,60
4901 22 1587	5/8"	156	58	365	10	119,10
4901 22 1905	3/4"	176	66	600	5	166,65

4901

Allen Anahtar Takım Altı Köşe (SAE) Hex Key Wrench Set (SAE)



KOD CODE	İÇERİK CONTENTS	g	TL/Ad.	
4901 00 3110	5/64" - 3/32" - 1/8" - 5/32" 3/16" - 7/32" - 1/4" - 5/16" 3/8" - 7/16"	405	10	172,50
4901 00 3112	5/64" - 3/32" - 1/8" - 5/32" 3/16" - 7/32" - 1/4" - 5/16" 3/8" - 7/16" - 1/2" - 9/16"	855	12	301,65

(★) İşaretili olan ürünler stoklarla sınırlıdır.

4903

Allen Anahtar Altı Köşe Uzun Boy (mm)
Hex Key Wrench Long Pattern (mm)

TS ISO 2936
DIN ISO 2936



Krom Vanadyum, Nikel Kaplı
Chrom Vanadium, Nickel Plated

KOD CODE	mm	L mm	L1 mm	g	TL/ Ad.	
4903 22 0020	2	100	16	3	10	7,30
4903 22 0025	2.5	112	18	5	10	8,55
4903 22 0030	3	126	20	10	10	9,75
4903 22 0035	3.5	136.5	22	15	10	11,95
4903 22 0040	4	140	25	20	10	12,25
4903 22 0050	5	160	28	30	10	13,80
4903 22 0060	6	180	32	50	10	22,40
4903 22 0070	7	190	34	80	10	33,30
4903 22 0080	8	200	36	100	10	36,25
4903 22 0090	9	210	38	145	10	49,20
4903 22 0100	10	224	40	180	10	61,00
4903 22 0120	12	250	45	285	10	87,75
4903 22 0140	14	280	56	460	5	141,30
4903 22 0160	16	290	60	625	5	228,65
4903 22 0170	17	320	63	750	5	249,00
4903 22 0190	19	360	70	1100	5	369,00

4903

Allen Anahtar Takım Altı Köşe Uzun Boy (mm)
Hex Key Wrench Set Long Pattern (mm)



KOD CODE	İÇERİK CONTENTS	g	TL/Ad.	
4903 00 3110	2 - 2.5 - 3 - 4 - 5 - 6 7 - 8 - 9 - 10	660	10	253,80
4903 00 3112	2 - 2.5 - 3 - 3.5 - 4 - 5 6 - 7 - 8 - 9 - 10 - 12	940	12	353,50

4905

Yuvarlak Başlı Allen Anahtar (mm)
Hex Key Wrench Ballpoint (mm)



Krom Vanadyum, Nikel Kaplı
Chrom Vanadium, Nickel Plated

KOD CODE	mm	L mm	L1 mm	g	TL/ Ad.	
4905 22 0020	2	50	16	3	10	8,20
4905 22 0025	2.5	56	18	4	10	9,85
4905 22 0030	3	63	20	5	10	11,25
4905 22 0040	4	70	25	10	10	13,95
4905 22 0050	5	80	28	20	10	14,65
4905 22 0060	6	90	32	30	10	23,70
4905 22 0080	8	100	36	55	10	36,45
4905 22 0100	10	112	40	100	10	57,95

4905

Yuvarlak Başlı Allen Anahtar Takımı (8 Parça, mm)
Hex Key Wrench Ballpoint Set (8 Pcs, mm)

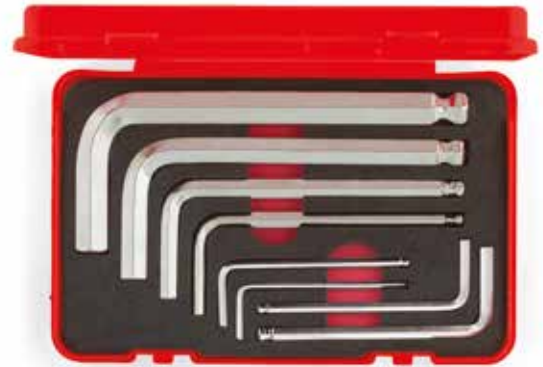

KOD CODE	İÇERİK CONTENTS	g	TL/Ad.	
4905 00 7108	2 - 2.5 - 3 - 4 5 - 6 - 8 - 10	275	8	176,00

(★) İşaretili olan ürünler stoklarla sınırlıdır.

4906

Yuvarlak Başlı Allen Anahtar Uzun Boy (mm)
Hex Key Wrench Ballpoint Long Pattern (mm)

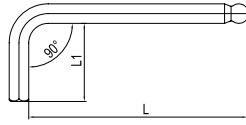

Krom Vanadyum, Nikel Kaplı
Chrom Vanadium, Nickel Plated

KOD CODE	mm	L mm	L1 mm	g	TL/Ad.
4906 22 0015	1.5	79	12	1.5	10,85
4906 22 0020	2	84	16	3	14,55
4906 22 0025	2.5	89	16	5	15,75
4906 22 0030	3	99	18	7	17,10
4906 22 0040	4	109	23	13	19,45
4906 22 0050	5	125	26	25	24,50
4906 22 0060	6	150	28	42	28,15
4906 22 0080	8	167	33	85	44,85
4906 22 0100	10	190	37	150	66,75

4910

Torx® Allen Anahtar
Torx® Key Wrench

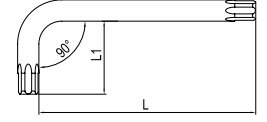

Krom Vanadyum, Nikel Kaplı
Chrom Vanadium, Nickel Plated

KOD CODE	☆	L mm	L1 mm	g	TL/Ad.
4910 22 0006	T6	42	16	2	10,34,40
4910 22 0007	T7	48	16	2	10,34,40
4910 22 0008	T8	48	16	3	10,34,40
4910 22 0009	T9	48	16	3	10,34,60
4910 22 0010	T10	51	17	4	10,34,60
4910 22 0015	T15	54	18	5	10,35,65
4910 22 0020	T20	57	19	5	10,37,30
4910 22 0025	T25	60	20	10	10,37,30
4910 22 0027	T27	64	21	15	10,37,30
4910 22 0030	T30	70	24	20	10,39,95
4910 22 0040	T40	76	26	30	10,42,55
4910 22 0045	T45	83	29	40	10,52,15
4910 22 0050	T50	95	32	60	10,59,40
4910 22 0055	T55	108	35	125	10,82,45
4910 22 0060	T60	120	38	185	10,113,60

4906

Yuvarlak Başlı Allen Anahtar Takım Altı Köşe Uzun Boy (9 parça, mm)
Hex Key Wrench Ballpoint Long Pattern Set (9 Pcs, mm)



KOD CODE	İÇERİK CONTENTS	g	TL/Ad.
4906 00 3109	1.5 - 2 - 2.5 - 3 - 4 - 5 - 6 8 - 10	355	9,241,95

4910

Torx® Allen Anahtar Takımı (8 Parça)
Torx® Key Wrench Set (8 Pcs)

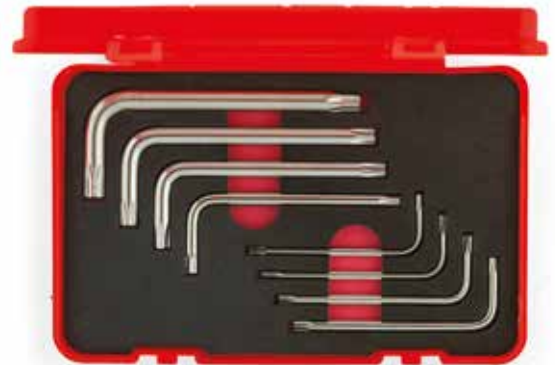

KOD CODE	İÇERİK CONTENTS	g	TL/Ad.
4910 00 7108	T9 - T10 - T15 T20 - T25 - T27 T30 - T40	155	8,299,25

(☆) İşaretili olan ürünler stoklarla sınırlıdır.

4912

Kaset Allen Anahtar Takımı (7 Parça, mm)
Hex Key Wrench Folding Set (7 Pcs, mm)



Krom vanadyum
Chrom vanadium

KOD CODE	İÇERİK CONTENTS	g	TL/Ad.
4912 00 3107	2.5 - 3 - 4 - 5 - 6 - 8 - 10	355	1 303,35

4912

Kaset Allen Anahtar Takımı (7 Parça, mm)
Hex Key Wrench Folding Set (7 Pcs, mm)



Krom vanadyum
Chrom vanadium

KOD CODE	İÇERİK CONTENTS	g	TL/Ad.
4912 00 0007	1.5 - 2 - 2.5 3 - 4 - 5 - 6	130	1 192,20

4909

T Tipi Torx Allen Anahtar
T Handle Torx Key Wrench

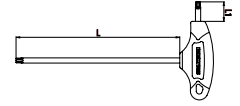

Krom vanadyum, Nikel kaplı
Chrom vanadium, Nickel plated

KOD CODE	☆	L1 mm	L2 mm	g	TL/Ad.
4909 22 0009	T9	125	15	22	5 87,75
4909 22 0010	T10	125	15	22	5 89,40
4909 22 0015	T15	125	15	26	5 91,30
4909 22 0020	T20	125	15	44	5 92,05
4909 22 0025	T25	150	20	49	5 94,15
4909 22 0027	T27	150	20	62	5 104,65
4909 22 0030	T30	150	20	82	5 107,55
4909 22 0040	T40	175	25	100	5 111,55

4909

T Tipi Torx Allen Anahtar Takımı (8 Parça)
T Handle Torx Key Wrench Set (8 Pcs)



KOD CODE	İÇERİK CONTENTS	g	TL/Ad.
4909 00 8108	T9 - T10 - T15 - T20 T25 - T27 - T30 - T40	407	8 778,40

(★) İşaretili olan ürünler stoklarla sınırlıdır.

4920

T Tipi Allen Anahtar (mm)
Hex Key Wrench T - Handle (mm)

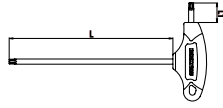

Krom Vanadyum
Chrom Vanadium

KOD CODE	mm	L mm	L1 mm	g	TL/Ad.	
4920 22 0025	2.5	110	14	20	5	47,35
4920 22 0030	3	125	17	23	5	48,25
4920 22 0040	4	140	20	45	5	54,05
4920 22 0050	5	155	23	58	5	57,75
4920 22 0060	6	170	26	100	5	66,00
4920 22 0070	7	185	30	125	5	69,30
4920 22 0080	8	200	34	150	5	81,45
4920 22 0100	10	220	40	240	5	123,30

4921

T Tipi Yuvarlak Başlı Allen Anahtar (mm)
Hex Key Wrench T - Handle Ballpoint (mm)

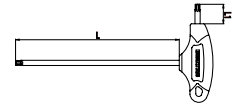

Krom Vanadyum
Chrom Vanadium

KOD CODE	mm	L mm	L1 mm	g	TL/Ad.	
4921 22 0025	2.5	110	14	20	5	61,45
4921 22 0030	3	125	17	23	5	62,25
4921 22 0040	4	140	20	45	5	69,90
4921 22 0050	5	155	23	58	5	75,00
4921 22 0060	6	170	26	100	5	85,70
4921 22 0070	7	185	30	125	5	89,85
4921 22 0080	8	200	34	150	5	96,55
4921 22 0100	10	220	40	235	5	160,20

4920

T Tipi Allen Anahtar Takımı (8 Parça, mm)
Hex Key Wrench T - Handle Set (8 Pcs, mm)



KOD CODE	İÇERİK CONTENTS	g	TL/Ad.	
4920 00 8108	2.5 - 3 - 4 - 5 6 - 7 - 8 - 10	760	8	547,45

4921

T Tipi Yuvarlak Başlı Allen Anahtar Takımı (8 Parça, mm)
Hex Key Wrench T - Handle Ballpoint Set (8 Pcs, mm)



KOD CODE	İÇERİK CONTENTS	g	TL/Ad.	
4921 00 8108	2.5 - 3 - 4 5 - 6 - 7 - 8 - 10	755	8	700,90

(★) İşaretli olan ürünler stoklarla sınırlıdır.

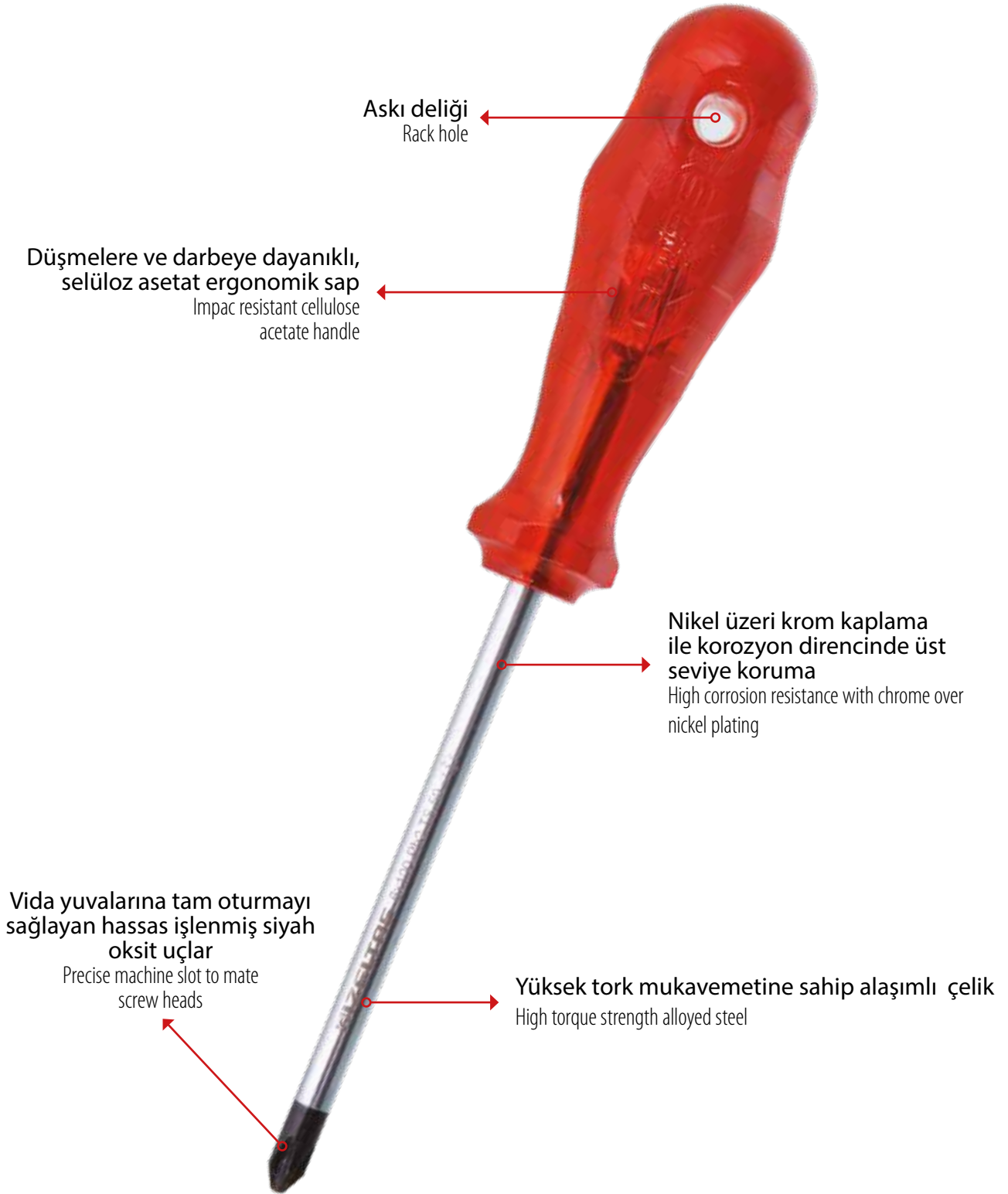

IZELTAS®

KESKİLER VE ÇEKİÇLER

CHISELS AND HAMMERS

Keskiler
Chisels

Zimbalar
Punches

Çekiçler
Hammers

Keserler
Adzes



Darbeyi eşit olarak dağıtmaya yarayan yuvarlak çelik kama
Steel wedge to equally distribute impact

İndüksiyonda sertleştirilmiş darbe yüzeyleri
Induction hardened impact surfaces

Yüksek karbonlu sıcak dövme çeliği ile artırılmış dayanım
High carbon, hot forged steel

Sapın çıkmasını engelleyen epoksi yapıştırıcı
Epoxy glue to prevent handle separation

İndüksiyonda sertleştirilmiş darbe yüzeyleri
Induction hardened impact surfaces

Sap-gövde birleşiminden kırılmayı önleyen çelik yüzük
Steel bushing to prevent breakage at the head and handle connection area

Dişbudak ağacından üretilmiş, el ergonomisine uygun özel tasarımı, vernikli ahşap sap
Ergonomic special design handle produced from strong ash tree hardwood



İZELTAS USTA İŞİ
SOHBETLER

5010

Iskarpela (Düz) Wood Chisel

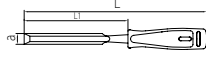

Özel alaşımli çelik, Uç indüksiyonda sertleştirilmiş, PP Saplı
Special steel, Induction hardened tips, PP Handle

KOD CODE	a mm	L mm	L1 mm	g	TL/Ad.	
5010 23 0006	6	245	120	115	5	87,45
5010 23 0008	8	245	122	125	5	93,45
5010 23 0010	10	245	124	135	5	98,75
5010 23 0012	12	245	126	135	5	108,35
5010 23 0014	14	245	128	145	5	112,05
5010 23 0016	16	255	130	150	5	119,85
5010 23 0018	18	255	132	160	5	129,90
5010 23 0020	20	255	134	170	5	144,50
5010 23 0022	22	255	136	190	5	156,60
5010 23 0024	24	255	138	195	5	169,20
5010 23 0026	26	255	140	200	5	175,30
5010 23 0030	30	260	146	205	5	187,20

5010

Iskarpela Takım (6 parça) Wood Chisel Set (6 Pcs)



KOD CODE	İÇERİK CONTENTS	g	TL/Ad.	
5010 00 8106	10 - 12 - 14 16 - 18 - 20	985	6	713,40

5500

Düz Keski Flat Cold Chisel

TS 492
DIN 6453



Özel alaşımli çelik, Krom kaplı
Special steel, Chrom plated

KOD CODE	L mm	a mm	g	TL/Ad.	
5500 23 0100	100	17	75	5	52,40
5500 23 0125	125	19	110	5	62,95
5500 23 0150	150	21	180	5	80,95
5500 23 0175	175	24	245	5	91,40
5500 23 0200	200	27	340	5	127,10
5500 23 0250	250	30	525	5	156,40
5500 23 0300	300	30	635	5	250,60

5500

Düz Keski (Kalkan İzoleli) Flat Cold Chisel (With Safety Handle)

TS 492
DIN 6453

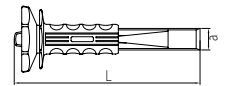

Özel alaşımli çelik, Krom kaplı
Special steel, Chrom plated

KOD CODE	L mm	a mm	g	TL/Ad.	
5500 23 1250	250	30	700	1	199,00
5500 23 1300	300	30	790	1	290,10

(★) İşaretli olan ürünler stoklarla sınırlıdır.

5510

Tesviyeci Düz Keski
Flat Cold Chisel Octagonal

TS 492
DIN 6453

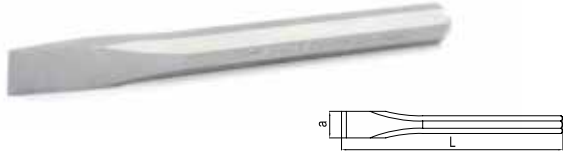

Krom vanadyum, Krom kaplı
Chrom vanadium, Chrom plated

KOD CODE	L mm	a mm	g	TL/Ad.
5510 23 0125	125	10	75	10 71,70
5510 23 0150	150	14	125	10 89,65

5520

Tırnak Keski
Cross Cut Chisel



Krom vanadyum, Krom kaplı
Chrom vanadium, Chrom plated

KOD CODE	L mm	a mm	g	TL/Ad.
5520 23 0125	130	5	70	10 80,45
5520 23 0150	150	6	110	10 95,95

5540

Nokta Zımba
Center Punch

DIN 7250



Krom vanadyum, Elektrostatik boyanmış
Chrom vanadium, Electrostatically painted

KOD CODE	L mm	L inch	øD mm	g	TL/Ad.
5540 24 4120	120	4 3/4"	4	65	10 60,60
5540 24 5120	120	4 3/4"	5	95	10 71,35
5540 24 5150	150	6"	5	115	10 79,05
★5540 24 0412	120	4 3/4"	4	65	10 59,90

★ Krom Kaplı / Chrom Plated

5545

Konik Pim Zımba
Drift Punch

DIN 6458

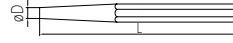

Krom vanadyum, Elektrostatik boyanmış
Chrom vanadium, Electrostatically painted

KOD CODE	L mm	L inch	øD mm	g	TL/Ad.
5545 24 0002	120	4 3/4"	2	90	10 52,15
5545 24 0003	120	4 3/4"	3	90	10 56,80
5545 24 0004	120	4 3/4"	4	90	10 63,90
5545 24 0005	120	4 3/4"	5	95	10 65,15
5545 24 0006	120	4 3/4"	6	95	10 96,05
5545 24 0007	120	4 3/4"	7	100	10 100,15
5545 24 0008	150	6"	8	125	10 103,95
5545 24 0009	150	6"	9	130	10 106,40
5545 24 0010	150	6"	10	130	10 108,55
5545 24 0012	150	6"	12	180	10 113,40
★5545 24 0103	120	4 3/4"	3	90	10 59,35

5550

Düz Pim Zımba
Split Pin Punch

DIN 6450

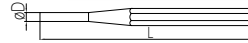

Krom vanadyum, Elektrostatik boyanmış
Chrom vanadium, Electrostatically painted

KOD CODE	L mm	L inch	øD mm	g	TL/Ad.
5550 24 0002	150	6"	2	70	5 74,75
5550 24 0003	150	6"	3	65	5 74,75
5550 24 0004	150	6"	4	65	5 76,00
5550 24 0005	150	6"	5	65	5 76,00
5550 24 0006	150	6"	6	70	5 76,60
5550 24 0007	150	6"	7	100	5 79,75
5550 24 0008	150	6"	8	105	5 85,45
5550 24 0009	150	6"	9	110	5 86,60
5550 24 0010	150	6"	10	120	5 87,45
★5550 24 0105	150	6"	5	65	5 66,75

5550

Düz Pim Zımba Takımı (6 Parça)
Split Pin Punch (6 Pcs)



KOD CODE	İÇERİK CONTENTS	g	TL/Ad.
5550 00 1006	3 - 4 - 5 - 6 - 7 - 8	865	6 468,55

(★) İşaretli olan ürünler stoklarla sınırlıdır.

5600

Keski Zimba Seti (6 Parça) Chisel And Punch Set (6 Pcs)

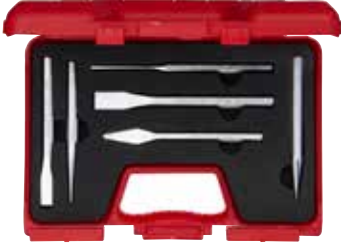

KOD CODE	İÇERİK CONTENTS	g	Ad.	TL/Ad.
5600 00 6106	125 Tevsiyeci Düz Keski 125 Flat Cold Chisel Octagonal	865	6	427,80
	150 Tevsiyeci Düz Keski 150 Flat Cold Chisel Octagonal			
	130 Tırnak Keski 130 Cross Cut Chisel			
	4x120 Nokta Zimba 4x120 Center Punch			
	5x150 Düz Pim Zimba 5x150 Split PinPunch			
	3x120 Konik Pim Zimba 3x120 Drift Punch			



5700

Kayış Zimba Belt Punch

DIN 7200
TSEK



Krom vanadyum, Elektrostatik boyanmış
Chrom vanadium, Electrostatically painted

KOD CODE	ØD mm	L mm	g	Ad.	TL/Ad.
5700 24 0003	3	105	35	10	44,75
5700 24 0004	4	105	40	10	46,80
5700 24 0005	5	110	50	10	50,85
5700 24 0006	6	110	60	10	51,75
5700 24 0007	7	115	75	10	57,05
5700 24 0008	8	115	90	10	60,65
5700 24 0009	9	120	100	10	67,65
5700 24 0010	10	120	110	10	72,05
5700 24 0011	11	125	130	5	77,50
5700 24 0012	12	125	165	5	92,75
5700 24 0013	13	130	165	5	97,65
5700 24 0014	14	130	180	5	107,20
5700 24 0015	15	135	245	5	123,05
5700 24 0016	16	135	300	5	134,65
5700 24 0017	17	140	365	5	147,25
5700 24 0018	18	140	380	5	160,65
5700 24 0019	19	145	405	5	174,60
5700 24 0020	20	145	450	5	185,95

5700

Kayış Zimba Takımı Belt Punch Set

TSEK



KOD CODE	İÇERİK CONTENTS	g	Ad.	TL/Ad.
5700 00 2110	3 - 4 - 5 - 6 - 7 8 - 9 - 10 - 11 - 12	845	10	621,80
5700 00 2112	3 - 4 - 5 - 6 - 7 - 8 - 9 10 - 11 - 12 - 13 - 14	1180	12	826,65

(*) İşaretili olan ürünler stoklarla sınırlıdır.

5800

Tesviyeci Çekiç
Machinist Hammer

TS 5-1
DIN 1041



İZELTAS YOUTUBE

Yedek parça sayfa 199
Spare parts page 199

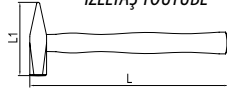

Özel alaşımlı çelik, İndüksiyonda sertleştirilmiş, Elektrostatik boyanmış
Special steel, Induction hardened, Electrostatically painted

KOD CODE	L mm	L1 mm	g	g	TL/Ad.
5800 25 0100	260	82	100	160	10 97,35
5800 25 0200	280	95	200	260	10 106,00
5800 25 0300	300	105	300	395	10 128,45
5800 25 0500	320	118	500	600	5 148,70
5800 25 1000	360	135	1000	1095	5 207,65
5800 25 1500	380	145	1500	1630	5 282,25
5800 25 2000	400	155	2000	2100	5 347,10

5810

Emniyet Çekici
Safety Hammer

TS 5-1

R&D
AR-GE

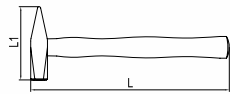

Özel alaşımlı çelik, İndüksiyonda sertleştirilmiş, Elektrostatik boyanmış
Special steel, Induction hardened, Electrostatically painted

KOD CODE	L mm	L1 mm	g	g	TL/Ad.
5810 25 1000	360	135	1000	1095	5 280,35
5810 25 1500	380	145	1500	1630	5 387,85
5810 25 2000	400	155	2000	2100	5 479,05

Emniyet çekici

Çekiç kafası ile sapın birleşiminde yuvarlak kama ve yapışkan malzeme kullanılarak sağlamlığı artırılmış ayrıca birleşimi çelik sac malzeme ile desteklenerek güvenli kullanım sağlanmıştır.

Safety Hammer

Connection between the hammer head and the handle is ensured by circular wedge and epoxy glue, while it is also reinforced by sheet metal for safe use.

5850

Plastik Çekiç
Plastic Hammer

TS 5

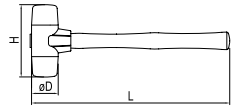

Yedek parça sayfa 199
Spare parts page 199

Darbeye dayanıklı, Kolay değiştirilebilir başlık
Durable and easily changeable heads

KOD CODE	L mm	øD mm	H mm	g	TL/Ad.
5850 25 0030	300	30	100	345	5 136,30
5850 25 0040	320	40	110	645	5 165,85
5850 25 0050	350	50	120	1015	5 207,35

5870

Lastik Çekiç
Rubber Hammer

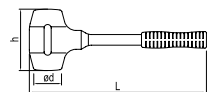

KOD CODE	L mm	ød mm	h mm	g	g	TL/Ad.
5870 25 0400	300	47	104	400	610	5 269,50

(*) İşaretili olan ürünler stoklarla sınırlıdır.

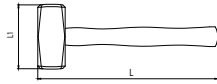
5865
Madırğa
Mallet

Yedek parça sayfa 199
Spare parts page 199
Özel alaşımli çelik
Special steel

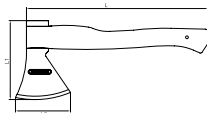
KOD CODE	L mm	L1 mm				TL/Ad.
5865 25 1000	260	95	1000	1210	5	256,85
5865 25 1500	280	110	1500	1770	5	306,80

6410
Nacak
Hatchet

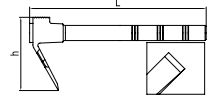
Yedek parça sayfa 199
Spare parts page 199
Özel alaşımli çelik, İndüksiyonda sertleştirilmiş, Elektrostatik boyanmış
Special steel, Induction hardened, Electrostatically painted

KOD CODE	L mm	L1 mm	L2 mm				TL/Ad.
6410 25 0800	380	165	115	800	1065	1	512,85

6400
Keser
Adze

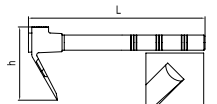
Yedek parça sayfa 199
Spare parts page 199
Özel alaşımli çelik, İndüksiyonda sertleştirilmiş, Elektrostatik boyanmış, PVC ağız koruyucu
Special steel, Induction hardened, Electrostatically painted, PVC cutting edge protector

KOD CODE	L mm	h mm				TL/Ad.
6400 25 0600	400	125	400	550	5	283,15

6401
Usta Keseri
Master Adze

Yedek parça sayfa 199
Spare parts page 199
Özel alaşımli çelik, İndüksiyonda sertleştirilmiş, Elektrostatik boyanmış, PVC ağız koruyucu
Special steel, Induction hardened, Electrostatically painted, PVC cutting edge protector

KOD CODE	L mm	h mm				TL/Ad.
6401 25 0600	400	125	400	540	5	283,15

(★) İşaretili olan ürünler stoklarla sınırlıdır.



ZELTAS
DIN 5131 5232

PRODUCTION
MADE IN SWEDEN
800 GR

5410



ZELTAS

GENEL EL ALETLERİ

GENERAL HAND TOOLS

Servis Aletleri
Service Equipment

Perçin Tabancası
Riveting Pliers

İşkenceler
Clamps

İnşaat Ekipmanları
Construction Equipment

Metreler
Measuring Tapes

Mengene
Forged Steel Vice

Su Terazisi
Straight Level

Gres Pompası
Grease Gun



KABLO SIYIRICI (KANCA BIÇAKLI) / CABLE STRIPPER (WITH HOOKED BLADE)

Tüm standart kabloları
sıyırmak için daha uzun ömür,
daha hızlı kesme ve daha az
aşınma sağlayan özel
titanyum nitrür (TIN)
kaplama
Tin plated long lasting/fast cutting blade to
strip all standard cables

Özel alışımlı çelikten
sertleştirilmiş ve kaplanmış
kanca bıçak
Plated special alloy hardened steel hook blade

Kapasite 8-28mm
çaplı kablolar
için uygun
Suitable for 8-28mm
diameter cables

Özel kaydırmaz formu
dayanıklı polyamid (PA) sap
Non-slip and durable
polyamid handle

Çevirerek kolay
bıçak yükseklik ayarı
Easy-to-rotate blade height adjuster

03750

Kablo Sıyrıcı (Kanca Bıçaklı)
Cable Stripper (With Hooked Blade)



 **Yedek parça sayfa 199**
Spare parts page 199

KOD CODE	ÖLÇÜ SIZE	g	TL/Ad.
03750 50 020	Ø8-28	79	5 194,65

03753

Mekanik Kablo Sıyrıcı
Mechanical Cable Stripper



KOD CODE	ÖLÇÜ SIZE	g	TL/Ad.
03753 50 054	0.5/4	100	5 333,00

03752

Kablo Sıyrıcı
Cable Stripper



 **Yedek parça sayfa 199**
Spare parts page 199



İZELTAS YOUTUBE

KOD CODE	ÖLÇÜ SIZE	g	TL/Ad.
03752 50 625	Tek 6/300 Çok 1.5/25	70	5 177,10

05881

Krom Şerit Metre
Chrom Steel Case, Measuring tapes



KOD CODE	ÖLÇÜ SIZE M	g	TL/Ad.
05881 50 013	3	160	5 93,65
05881 50 015	5	220	5 105,75

03751

Koaksiyel Kablo Sıyrıcı
Coaxial Cable Stripper



İZELTAS YOUTUBE

KOD CODE	ÖLÇÜ SIZE	g	TL/Ad.
03751 50 012	Dış (1) İç (2)	20	5 252,65

05881

Plastik Şerit Metre
Plastic Steel Case, Measuring tapes



KOD CODE	ÖLÇÜ SIZE M	g	TL/Ad.
05881 50 003	3	145	5 78,70
05881 50 005	5	200	5 94,55

(*) İşaretli olan ürünler stoklarla sınırlıdır.

05886**Arazi Tipi Fiberglas Şerit Metre (Saplı)**
Fiberglass Measuring Tape Field Type (With Holder)

KOD CODE	ÖLÇÜ SIZE M	g		TL/Ad.
05886 50 020	20	520	1	189,85
05886 50 030	30	585	1	202,70
05886 50 050	50	820	1	325,60

05880**Su Terazisi**
Straight Level**Alüminyum gövde**
Aluminium body

KOD CODE	L mm	g		TL/Ad.
05880 50 040	400	250	5	283,25
05880 50 050	500	300	5	307,20
05880 50 060	600	350	5	334,05
05880 50 070	700	400	5	358,65
05880 50 080	800	450	5	387,50
05880 50 100	1000	500	5	441,10
05880 50 120	1200	550	5	522,00
05880 50 150	1500	600	5	601,45
05880 50 200	2000	800	5	840,25

05887**Kumpas**
Vernier**Sürgülü, Stoplu**
Sliding and with stop

KOD CODE	L mm	g		TL/Ad.
05887 50 150	150	155	5	683,85

05890**Testere Kolu**
Hacksaw Frame **Yedek parça sayfa 200**
Spare parts page 200

KOD CODE	L mm	g		TL/Ad.
05890 50 830	300	540	5	296,25

6735**Dal Budama Testeresi**
Pruning Saw **Yedek parça sayfa 200**
Spare parts page 200

KOD CODE	L mm	g		TL/Ad.
6735 27 0300	300	400	5	296,75

(*) İşaretili olan ürünler stoklarla sınırlıdır.

05901

Sentil (20 Parça, mm)
Feeler Gauges (20 Pcs, mm)



KOD CODE	ÖLÇÜ SIZE mm	g		TL/Ad.
05901 50 020	0.05 - 1	90	10	62,45

05902

Sentil (20 Parça, SAE)
Feeler Gauges (20 Pcs, SAE)



KOD CODE	ÖLÇÜ SIZE inch	g		TL/Ad.
05902 50 020	2 - 35/1000"	65	10	97,65

6225

Madeni Yağdanlık (Flexible Uçlu)
Oiler With Flexible Spout



KOD CODE	ÖLÇÜ SIZE cc	g		TL/Ad.
6225 26 0200	200	170	5	104,30
6225 26 0300	300	200	5	117,35
6225 26 0500	500	225	5	128,80

6195

Perçin Tabancası
Riveting Pliers



KOD CODE	ÖLÇÜ SIZE	CAPACITY mm	g		TL/Ad.
6195 26 0260	260	2 - 2.5 - 3 - 3.2	625	1	312,45

6220

Spiralli Mıknatıs
Flexible Magnet Holder

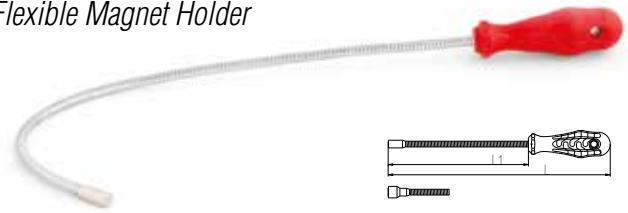

KOD CODE	KAPASİTE g	L mm	L1 mm	g		TL/Ad.
6220 26 0500	500	465	375	100	10	196,65
6220 26 1000	1000	465	375	105	10	208,25

(★) İşaretili olan ürünler stoklarla sınırlıdır.

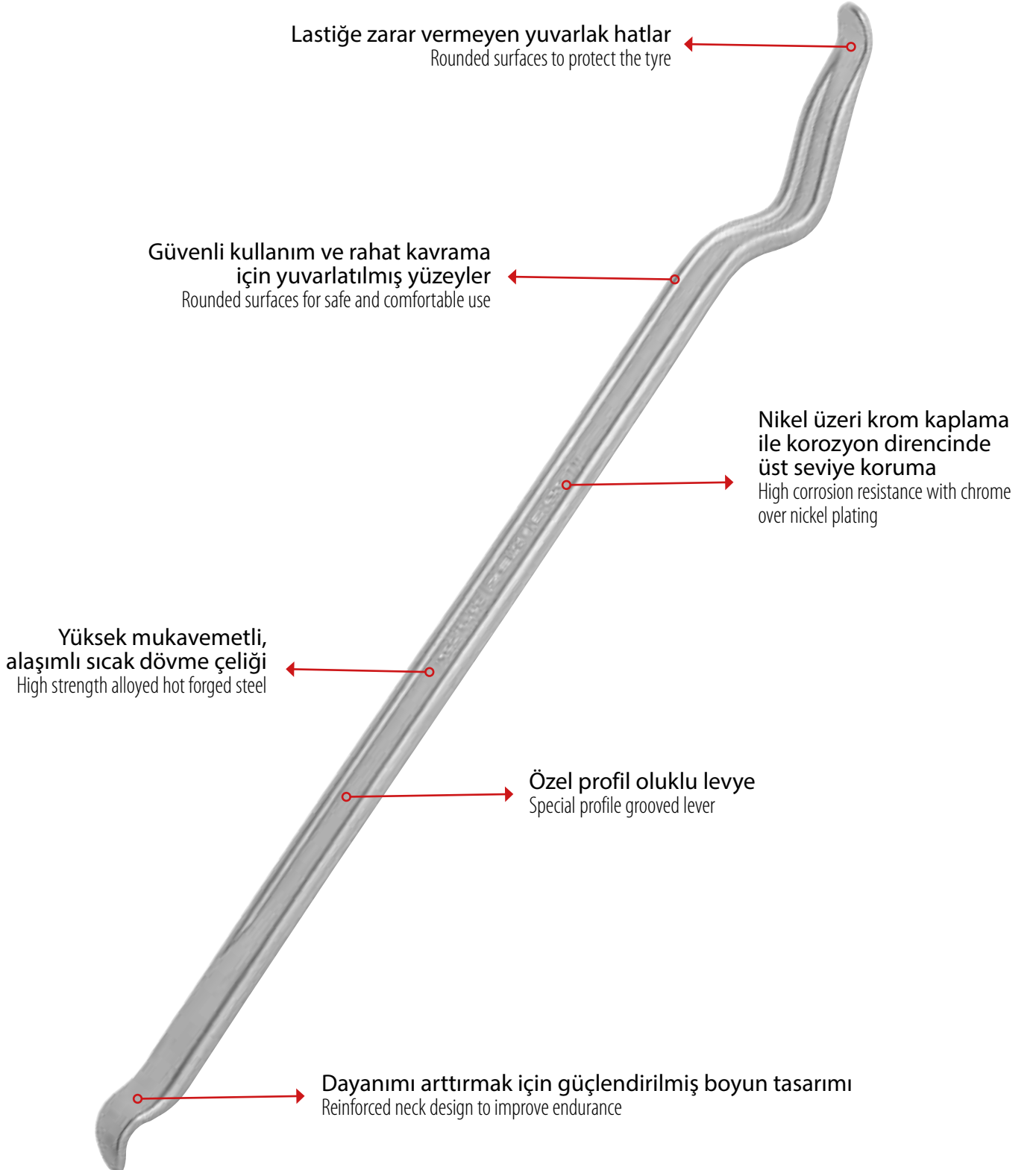

6230

Gres Pompası
Grease Gun

 Yedek parça sayfa 206
Spare parts page 206



KOD CODE	ÖLÇÜ SIZE cc	g	TL/Ad.
6230 26 0300	300	1200	1 268,00
6230 26 0500	500	1320	1 330,10

6360

Levye Oluklu Kıvrık Uçlu
Tyre Lever, Bent

TSEK



Krom vanadyum, Krom kaplı
Chrom vanadium, Chrom plated

KOD CODE	L mm	L inch	g	TL/Ad.
6360 26 0600	600	24"	910	5 221,90

6240

Tapa Anahtarı (İki ağız)
Offset Wrench For Carter Case



KOD CODE	ÖLÇÜ mm	g	TL/Ad.
6240 26 0810	8x10	250	10 98,85

6370

Yağ Filtresi Sökeceği
Band Type Oil Filter Wrench



KOD CODE	Ø mm	g	TL/Ad.
6370 26 0100	75 - 100	335	5 146,60

6350

Levye Oluklu
Tyre Lever, Straight

TSEK



Krom vanadyum, Krom kaplı
Chrom vanadium, Chrom plated

KOD CODE	L mm	L inch	g	TL/Ad.
6350 26 0300	300	12"	265	5 93,80
6350 26 0400	400	16"	440	5 118,25
6350 26 0500	500	20"	675	5 164,50
6350 26 0600	600	24"	900	5 200,85



(★) İşaretili olan ürünler stoklarla sınırlıdır.

6375

Çift Yönlü Üç Ayaklı Yağ Filtresi Sökeceği
Left and Right Hand Operation, Triple Leg Oil Filter Wrench

**3/8" - 1/2"**

KOD CODE	Ø mm	g	TL/Ad.
6375 26 6512	75-120	605	5 512,85

06374

Zincirli Yağ Filtresi Sökeceği
Chain Wrench



KOD CODE	Ø mm	g	TL/Ad.
06374 50 140	60x140	390	5 309,65

6380

Çift Zincirli Yağ Filtresi Sökeceği
Oil Filter Wrench With Double Chain



KOD CODE	Ø mm	g	TL/Ad.
6380 26 6016	60-160	380	5 1388,90

06373

Kayıslı Yağ Filtresi Sökeceği
Strap Wrench



KOD CODE	Ø mm	g	TL/Ad.
06373 50 140	60x140	245	5 359,35

06375

Ayarlı Yağ Filtresi Sökeceği
Adjustable Slot Type Oil Filter Wrench



Yedek parça sayfa 199
Spare parts page 199

KOD CODE	Ø mm	g	TL/Ad.
06375 50 100	65-110	215	5 171,65

(*) İşaretili olan ürünler stoklarla sınırlıdır.

06390

Segman Çemberi
Piston Ring Compressor



KOD CODE	Ø mm	g	□	TL/Ad.
06390 50 125	125	235	5	306,45
06390 50 175	175	505	5	584,65

07415

Sıralı Tel Fırça (Ağaç Saplı)
Hand Brush (Wooden Handle)



KOD CODE	ÖLÇÜ SIZE	g	□	TL/Ad.
07415 50 003	3 SIRA 3 RAWS	125	5	22,60
07415 50 004	4 SIRA 4 RAWS	135	5	23,90
07415 50 005	5 SIRA 5 RAWS	145	5	26,70
07415 50 006	6 SIRA 6 RAWS	170	5	28,55

07416

Kıvrık Uçlu Fırça (Plastik Saplı)
Hand Brush (PP Handle)



KOD CODE	L mm	g	□	TL/Ad.
07416 50 001	270	110	5	35,35

07410

Makaralı Uzatma Kablosu
(El Tipi)
Extension Cord Reel
(With Handle)



Kablo / Cable ø 3x1.5 mm

KOD CODE	MODEL	ÖLÇÜ SIZE	g	□	TL/Ad.
07410 50 010	el tipi / with handle	10	1400	1	708,85

07410

Makaralı Uzatma Kablosu
(Ayaklı)
Extension Cord Reel
(With Stand)



Kablo / Cable ø 3x1.5 mm

KOD CODE	MODEL	ÖLÇÜ SIZE	g	□	TL/Ad.
07410 50 025	ayaklı / with stand	25	4130	1	1252,70
07410 50 050	ayaklı / with stand	50	6745	1	2501,40



(★) İşaretili olan ürünler stoklarla sınırlıdır.

DÖVME ÇELİK MENGENE/TFORGED STEEL VICE WITH SWIVEL BASE

Isıl işlem sonrasında ilave olarak yapılan
indüksiyonda sertleştirme işlemi ile güçlü
tutuş sağlayan özel profilli çeneler
Heat treated and induction hardened special profile jaws for powerful
grip

İndüksiyonda
sertleştirilmiş darbeye
dayanıklı yüzeyler
Induction hardened impact resistant
surfaces

Yüksek
karbonlu sıcak
dövme çeliği ile
artırılmış dayanım
Improved lifetime with hot
forged high carbon steel

İndüksiyonda
sertleştirme ile
kullanım ömrü
arttırılmış, korozyona
karşı çinko ile
kaplanmış ilerleme mili
High strength alloyed steel. High
corrosion protection with chrome
over nickel plating

Elektrostatik fırın
boya ile korozyon
direnci sağlanmış
yüzeyler
High corrosion resistance
with electrostatic powder
paint

Yüksek mukavemetli,
alaşımli çelik
Nikel üzerine krom
kaplama ile sağlanan,
korozyon direncinde
üst seviye koruma
High strength alloyed steel. High
corrosion protection with chrome
over nickel plating

İlerleme mili
koruma sacı
Protective cover
screw spindle

Çevirme kolunun
yerinden çıkmaması
için kullanılan
kauçuklar
Rubber stoppers to keep the bar on
the spindle

Çelik döküm
mengene altlığı
Cast steel base plate

Mengenenin 360°
dönmesini sağlayan
çelik döner parça
Vice plate for 360° rotation

7401

Mengene Döner Tablası Swivel Base of Vice



Özel alaşım çelik, Krom kaplı
Special steel, Chrom plated

KOD CODE	ÖLÇÜ SIZE	σd mm	σD mm	g	TL/Ad.
7401 30 0100	100	10.5	160	1550	473,30
7401 30 0125	125	12.5	200	2700	625,45
7401 30 0150	150	12.5	240	3800	759,20
7401 30 0175	175	12.5	280	6650	858,35

7400

Dövme Çelik Mengene Forged Steel Vice

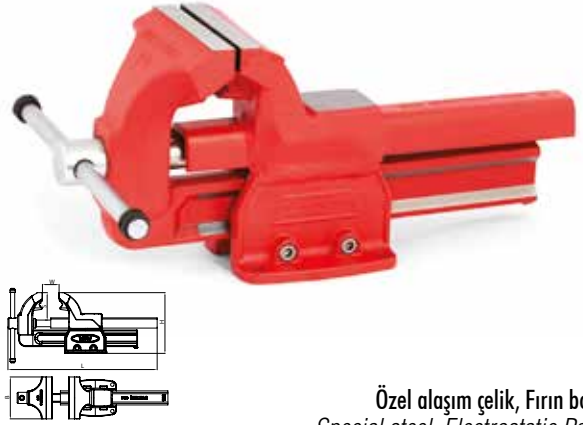

Özel alaşım çelik, Fırın boya
Special steel, Electrostatic Paint

KOD CODE	B mm	W mm	H mm	L mm	g	TL/Ad.
7400 30 0100	100	125	148	440	5000	1607,65
7400 30 0125	125	155	183	550	11000	2213,35
7400 30 0150	150	180	220	675	20000	2830,70
7400 30 0175	175	205	245	760	29000	3482,75

7400

Dövme Çelik Mengene (Döner Tabla dahil) Forged Steel Vice with Swivel Base





Özel alaşım çelik, Fırın boya
Special steel, Electrostatic Paint

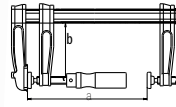

KOD CODE	B mm	g	TL/Ad.
7400 00 0100	100	6550	2080,95
7400 00 0125	125	13700	2838,80
7400 00 0150	150	23800	3589,90
7400 00 0175	175	35650	4341,10

(★) İşaretli olan ürünler stoklarla sınırlıdır.

İşkence (Marangoz Mengenesi Plastik Ağzılı)
Carpenter Screw Clamp

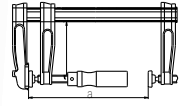
Darbeye dayanıklı çeneler
Impact resistant cast iron jaws

KOD CODE		a mm	b mm	 g		TL/Ad.
7300 30 3012	30x12	300	120	1605	5	373,75
7300 30 4012	40x12	400	120	1780	5	441,55
7300 30 5012	50x12	500	120	1935	5	452,65
7300 30 6012	60x12	600	120	2080	5	472,50
7300 30 8012	80x12	800	120	2470	5	501,15
7300 30 1012	100x12	1000	120	2790	5	571,95

Mini İşkence
Mini Clamp

Alaşımlı alüminyum çeneler
Alloyed aluminum jaws

KOD CODE		a mm	b mm	 g		TL/Ad.
7310 30 1005	10x5	100	50	250	5	160,75
7310 30 1505	15x5	150	50	280	5	169,40
7310 30 2005	20x5	200	50	310	5	175,65
7310 30 2505	25x5	250	50	330	5	183,10
7310 30 3005	30x5	300	50	360	5	189,55



IZELTAS®

MAKASLAR

SHEARS

Demir Kesme Makası
Bolt Cutters

Saç Makasları
Sheet Metal Cutters

Plastik Boru Kesme Makası
Plastic Pipe Cutters

Bağ Makasları
Prunnig Shears



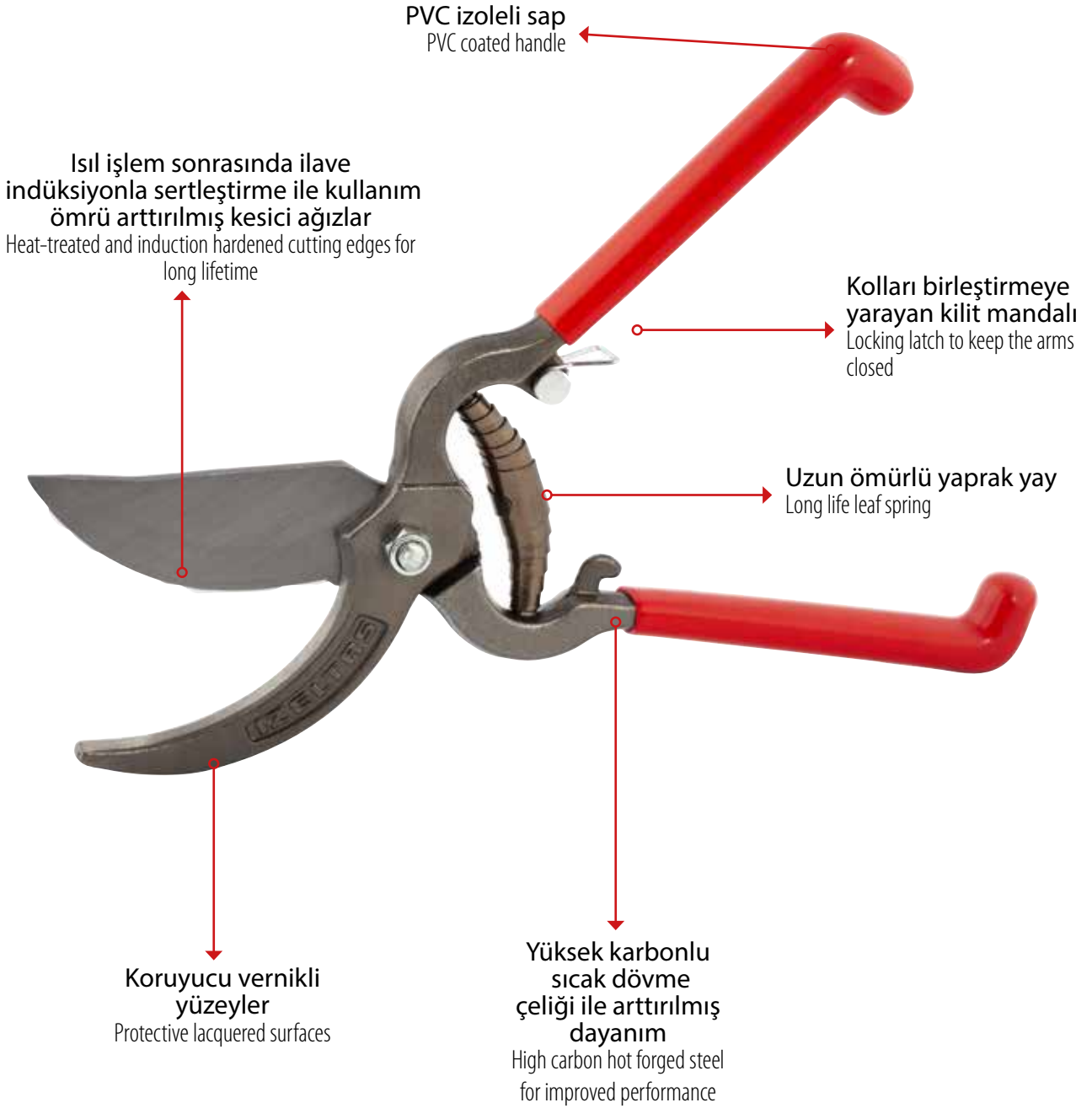

2350

Demir Kesme Makası Bolt Cutters



 Yedek parça sayfa 198
Spare parts page 198

Özel alaşımlı çelik, Kesici ağızlar indüksiyonda sertleştirilmiş,
Elektrostatik boyanmış çeneler ve bağlantı parçaları dövme
Special steel, Cutters induction hardened,
Electrostatically painted jaws and connection parts drop forged

KOD CODE	L mm	L inch	KAPASİTE CAPACITY Ø mm	g	TL/Ad.
2350 27 0018	450	18"	6 - 8	1510	1 610,60
2350 27 0024	600	24"	8 - 10	2350	1 898,75
2350 27 0030	750	30"	9 - 13	3750	1 1406,95
2350 27 0036	900	36"	11 - 16	5500	1 1820,90

2350

Demir Kesme Makası Sehpası (Dolu) Bolt Cutters Frame



KOD CODE	İÇERİK CONTENTS	g	TL/Ad.
2350 00 6104	18"(450) - 24"(600) 30"(750) - 36"(900)	21.110	4 5818,30

6205

Alüminyum Ve Sac Kesme Makası Sağ Snip For Aluminum and Metal Sheet (Right)



Özel alaşımlı çelik, Kesici ağızlar indüksiyonda sertleştirilmiş,
Special steel, Cutters induction hardened,

KOD CODE	L mm	L inch	g	TL/Ad.
6205 27 0240	240	10"	380	5 241,35

6206

Alüminyum Ve Sac Kesme Makası Sol Snip For Aluminum and Metal Sheet (Left)



Özel alaşımlı çelik, Kesici ağızlar indüksiyonda sertleştirilmiş
Special steel, Cutters induction hardened

KOD CODE	L mm	L inch	g	TL/Ad.
6206 27 0240	240	10"	380	5 241,35

6207

Alüminyum Ve Sac Kesme Makası Düz Snip For Aluminum and Metal Sheet (Flat)



Özel alaşımlı çelik, Kesici ağızlar indüksiyonda sertleştirilmiş
Special steel, Cutters induction hardened

KOD CODE	L mm	L inch	g	TL/Ad.
6207 27 0240	240	10"	380	5 241,35

(*) İşaretili olan ürünler stoklarla sınırlıdır.

6210

Kaportacı Makası (Sağ)
Punch Snip (Right)

DIN 6438



Özel alaşımli çelik, Kesici ağızlar indüksiyonda sertleştirilmiş, PVC izoleli
Special steel, Cutters induction hardened, PVC insulated

KOD CODE	L mm	L inch	g	TL/Ad.	
6210 27 0250	250	10"	555	5	303,45
6210 27 0275	275	11"	600	5	331,90
6210 27 0300	300	12"	640	5	378,45

6211

Kaportacı Makası (Sol)
Punch Snip (Left)

DIN 6438



Özel alaşımli çelik, Kesici ağızlar indüksiyonda sertleştirilmiş, PVC izoleli
Special steel, Cutters induction hardened, PVC insulated

KOD CODE	L mm	L inch	g	TL/Ad.	
6211 27 0250	250	10"	535	5	303,45
6211 27 0275	275	11"	605	5	331,90
6211 27 0300	300	12"	665	5	378,45

6820

Tenekeci Makası
Tinman's Snip

TSEK



Özel alaşımli çelik, Kesici ağızlar indüksiyonda sertleştirilmiş, PVC izoleli
Special steel, Cutters induction hardened, PVC insulated

KOD CODE	L mm	L inch	g	TL/Ad.	
6820 27 0200	200	8"	320	5	204,00
6820 27 0250	250	10"	575	5	260,50
6820 27 0300	300	12"	870	5	283,95

6821

Tenekeci Makası (Yaylı)
Tinman's Snip (With Spring)

TSEK



Özel alaşımli çelik, Kesici ağızlar indüksiyonda sertleştirilmiş, PVC izoleli
Special steel, Cutters induction hardened, PVC insulated

KOD CODE	L mm	L inch	g	TL/Ad.	
6821 27 0250	250	10"	575	5	282,90
6821 27 0300	300	12"	895	5	309,50

6800

Kuyumcu Makası (Düz)
Jeweller's Snip (Straight)

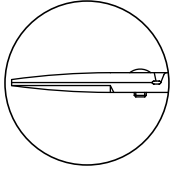

KOD CODE	L mm	L inch	g	□	TL/Ad.
6800 27 0180	180	7 1/8"	140	5	246,20

6815

Tel Kesme Makası
Bolt Cutters



KOD CODE	L mm	L inch	g	□	TL/Ad.
6815 27 0200	200	8"	295	5	124,50

6801

Kuyumcu Makası (Eğri)
Jeweller's Snip (Curved)

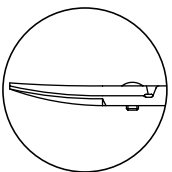

KOD CODE	L mm	L inch	g	□	TL/Ad.
6801 27 0180	180	7 1/8"	140	5	269,30

6740

Kombine Makas
Multi Purpose Scissors



KOD CODE	L mm	L inch	g	□	TL/Ad.
6740 27 0140	140	5 1/2"	60	5	225,40
6740 27 0190	190	7 1/2"	120	5	264,50

(★) İşaretili olan ürünler stoklarla sınırlıdır.

6710**Bağ Makası (Lüks)**
Pruning Shears (Lux)

İZELTAS YOUTUBE

Özel alaşımli çelik, Kesici ağızlar indüksiyonda sertleştirilmiş, PVC izoleli
Special steel, Cutters induction hardened, PVC insulated

KOD CODE	L mm	L inch	g	TL/Ad.	
6710 27 0230	230	9"	390	5	217,50

6720**Bağ Makası (Hafif Tip)**
Pruning Shears (Light)

Alüminyum gövde, PVC izoleli
Aluminum forged body, PVC insulated

KOD CODE	L mm	L inch	g	TL/Ad.	
6720 27 0220	220	8 5/8"	265	5	384,15

6715**Bağ Makası (Comfort)**
Pruning Shears (Comfort)

Özel alaşımli çelik, PVC izoleli
Special steel, PVC insulated

KOD CODE	L mm	L inch	g	TL/Ad.	
6715 27 0225	225	9"	340	5	331,25

6712**Elma Makası**
Pruning Shears (Fruit)

Özel alaşımli çelik, Kesici ağızlar indüksiyonda sertleştirilmiş, PVC izoleli
Special steel, Cutters induction hardened, PVC insulated

KOD CODE	L mm	L inch	g	TL/Ad.	
6712 27 0210	210	8 1/4"	365	5	384,80

(★) İşaretli olan ürünler stoklarla sınırlıdır.

06760

Plastik Boru Kesme Makası
Plastic Pipe Cutter



 Yedek parça sayfa 200
Spare parts page 200

KOD CODE	Ø mm	g	□	TL/Ad.
06760 50 042	42	400	5	831,85
06760 50 063	63	610	5	1459,55

6850

Mini Boru Kesici (Bakır ve Alüminyum İçin)
Mini Tube Cutter (For Copper and Aluminum)



 Yedek parça sayfa 200
Spare parts page 200

KOD CODE	ÖLÇÜ SIZE	g	□	TL/Ad.
6850 28 0322	1/8" - 5/8"	120	1	179,25

6855

Standart Boru Kesici (Bakır ve Alüminyum İçin)
Standard Tube Cutter (For Copper and Aluminum)



 Yedek parça sayfa 200
Spare parts page 200

KOD CODE	ÖLÇÜ SIZE	g	□	TL/Ad.
6855 28 0330	1/8" - 1 1/8"	305	1	248,10

6860

Teleskopik Boru Kesici (Bakır ve Alüminyum İçin)
Telescopic Tube Cutter (For Copper and Aluminum)



 Yedek parça sayfa 200
Spare parts page 200

KOD CODE	ÖLÇÜ SIZE	g	□	TL/Ad.
6860 28 0635	1/4" - 1 3/8"	470	1	527,65

6865

Profesyonel Boru Kesici (Çelik İçin)
Professional Tube Cutter (For Steel)



 Yedek parça sayfa 200
Spare parts page 200

KOD CODE	ÖLÇÜ SIZE	g	□	TL/Ad.
6865 28 1050	1/8" - 2"	2380	1	1331,85



(*) İşaretili olan ürünler stoklarla sınırlıdır.



IZELTAS®

ÇEKTİRMELER

PULLERS

Çektirmeler

Pullers

İç Rulman Çektirmeler

Inside Pullers

Rotil Çektirmeler

Balljoint Pullers

Saplama Sökmeler

Stud Inserters and Removers



PULLERS

ÇEKTİRMELER

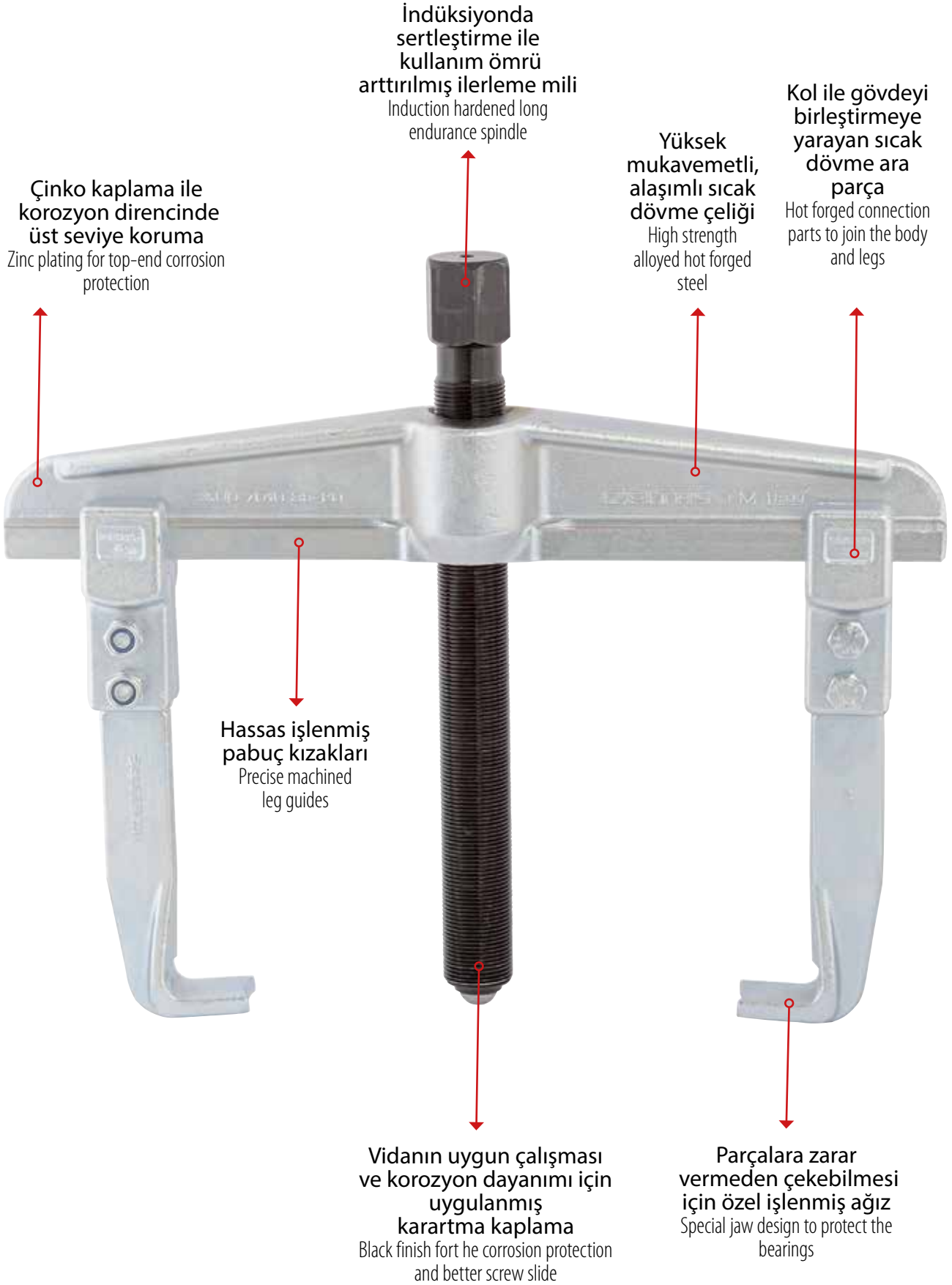
STANDART ÇEKTİRME İKİ KOLLU / STANDARD PULLER TWO ARMS

7010

Standart Çektirme (İki Kollu) Standard Puller (Two Arms)

TSEK



Yedek parça sayfa 201
Spare parts page 201

Krom vanadyum, Çinko kaplı, Kollar sertleştirilmiş,
Mil indüksiyonda sertleştirilmiş
Chrom vanadium, Zinc plated,
Arms hardened, Spindle induction hardened

KOD CODE		B mm	H mm			TL/Ad.
7010 29 0810	8x10	80	100	1080	1	610,80
7010 29 1210	12x10	120	100	1235	1	653,15
7010 29 1615	16x15	160	150	2850	1	1113,45
7010 29 2015	20x15	200	150	3060	1	1218,00
7010 29 2520	25x20	250	200	7450	1	2103,65
7010 29 3520	35x20	350	200	10000	1	2554,90
7010 29 5220	52x20	520	200	14100	1	3755,75

7010

Standart Çektirme Sehpası (Dolu) Display Frame For Pullers



KOD CODE	İÇERİK CONTENTS			TL/Ad.
7010 00 6105	8x10 - 12x10 - 16x15 20x15 - 25x20	17840	5	5926,10

7020

Standart Çektirme (Üç Kollu) Standard Puller (Three Arms)

TSEK



Yedek parça sayfa 201
Spare parts page 201

Krom vanadyum, Çinko kaplı, Kollar sertleştirilmiş,
Mil indüksiyonda sertleştirilmiş
Chrom vanadium, Zinc plated,
Arms hardened, Spindle induction hardened

KOD CODE		B mm	H mm			TL/Ad.
7020 29 3720	37x20	370	200	14750	1	4714,75
7020 29 5220	52x20	520	200	20000	1	6499,55



(★) İşaretili olan ürünler stoklarla sınırlıdır.

7030



Master Çektirme (İki Kollu)
Master Puller (Two Arms)

TSEK



 **Yedek parça sayfa 201**
Spare parts page 201

Krom vanadyum, Çinko kaplı, Kollar sertleştirilmiş,
Mil indüksiyonda sertleştirilmiş
Chrom vanadium, Zinc plated,
Arms hardened, Spindle induction hardened

KOD CODE		B mm	H mm	g		TL/Ad.
7030 29 0808	8x8	80	80	545	1	245,95
7030 29 1212	12x12	120	120	1075	1	507,25
7030 29 1616	16x16	160	160	1885	1	763,35
7030 29 2320	23x20	230	200	3240	1	1037,85

7040



Master Çektirme (Üç Kollu)
Master Puller (Three Arms)

TSEK



 **Yedek parça sayfa 201**
Spare parts page 201

Krom vanadyum, Çinko kaplı, Kollar sertleştirilmiş,
Mil indüksiyonda sertleştirilmiş
Chrom vanadium, Zinc plated,
Arms hardened, Spindle induction hardened

KOD CODE		B mm	H mm	g		TL/Ad.
7040 29 0808	8x8	80	80	680	1	471,20
7040 29 1212	12x12	120	120	1355	1	689,65
7040 29 1616	16x16	160	160	2320	1	1014,10
7040 29 2320	23x20	230	200	4025	1	1365,55

7050



Batarya Çektirme (İki Kollu)
Battery Puller (Two Arms)

TSEK



 **Yedek parça sayfa 201**
Spare parts page 201

Krom vanadyum, Çinko kaplı, Kollar sertleştirilmiş,
Mil indüksiyonda sertleştirilmiş
Chrom vanadium, Zinc plated,
Arms hardened, Spindle induction hardened

KOD CODE		B mm	H mm	g		TL/Ad.
7050 29 0604	6x4	60	40	245	1	273,75
7050 29 0606	6x6	60	60	275	1	282,25
7050 29 0808	8x8	80	80	555	1	296,35

7060



Batarya Çektirme (Üç Kollu)
Battery Puller (Three Arms)

TSEK



 **Yedek parça sayfa 201**
Spare parts page 201

Krom vanadyum, Çinko kaplı, Kollar sertleştirilmiş,
Mil indüksiyonda sertleştirilmiş
Chrom vanadium, Zinc plated,
Arms hardened, Spindle induction hardened

KOD CODE		B mm	H mm	g		TL/Ad.
7060 29 0604	6x4	60	40	300	1	355,30
7060 29 0606	6x6	60	60	345	1	448,05
7060 29 0808	8x8	80	80	715	1	519,70

(*) İşaretli olan ürünler stoklarla sınırlıdır.

7070

S Tipi Çektirme (İki Kollu) S Type Puller (Two Arms)

TSEK

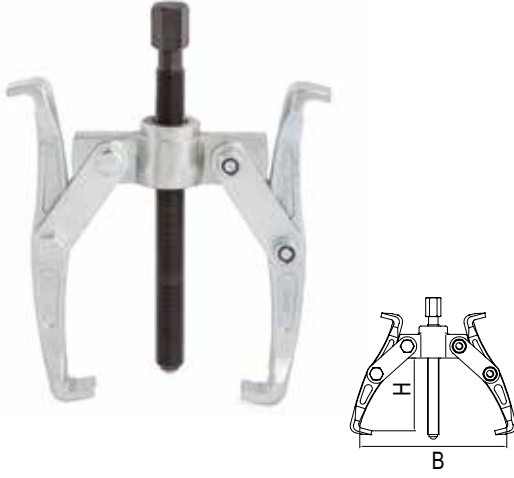

Yedek parça sayfa 201
Spare parts page 201

Krom vanadyum, Çinko kaplı, Kollar sertleştirilmiş,
Mil indüksiyonda sertleştirilmiş
Chrom vanadium, Zinc plated,
Arms hardened, Spindle induction hardened

KOD CODE		B mm	H mm	 g		TL/Ad.
7070 29 2013	20x13	200	130	2420	1	674,05

7090

Üniversal Çektirme (İki Kollu) Universal Puller (Two Arms)

TSEK

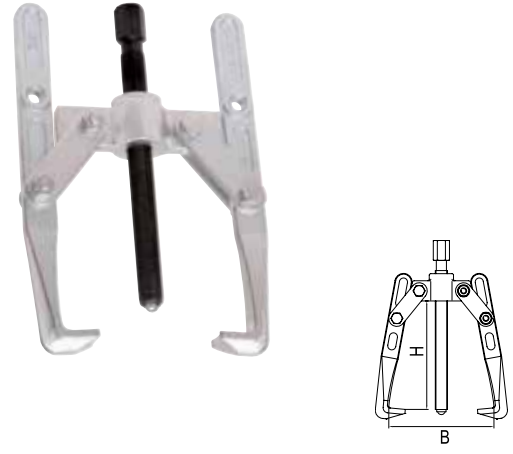

Yedek parça sayfa 201
Spare parts page 201

Krom vanadyum, Çinko kaplı, Kollar sertleştirilmiş,
Mil indüksiyonda sertleştirilmiş
Chrom vanadium, Zinc plated,
Arms hardened, Spindle induction hardened

KOD CODE		B mm	H mm	 g		TL/Ad.
7090 29 2222	22x22	220	220	3085	1	749,05

7080

S Tipi Çektirme (Üç Kollu) S Type Puller (Three Arms)

TSEK

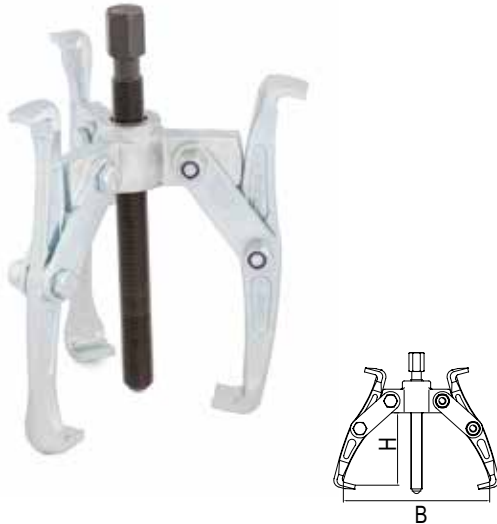

Yedek parça sayfa 201
Spare parts page 201

Krom vanadyum, Çinko kaplı, Kollar sertleştirilmiş,
Mil indüksiyonda sertleştirilmiş
Chrom vanadium, Zinc plated,
Arms hardened, Spindle induction hardened

KOD CODE		B mm	H mm	 g		TL/Ad.
7080 29 2013	20x13	200	130	3250	1	869,35

7100

Üniversal Çektirme (Üç Kollu) Universal Puller (Three Arms)

TSEK



Yedek parça sayfa 201
Spare parts page 201

Krom vanadyum, Çinko kaplı, Kollar sertleştirilmiş,
Mil indüksiyonda sertleştirilmiş
Chrom vanadium, Zinc plated,
Arms hardened, Spindle induction hardened

KOD CODE		B mm	H mm	 g		TL/Ad.
7100 29 2222	22x22	220	220	4125	1	981,90

(*) İşaretili olan ürünler stoklarla sınırlıdır.

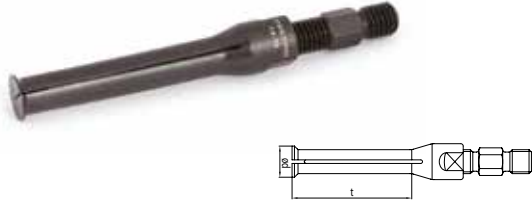
İç Rulman Çektirme Pensleri - Model A
Internal Expansion Puller - Model A

KOD CODE	øD mm	t mm	Kullanılan Kol / For	Adaptör vidası	g	TL/Ad.
7120 29 0507	5 - 7	30	35 - 75	M10	40	1 561,55
7120 29 0709	7 - 9	30	35 - 75	M10	40	1 561,55
7120 29 0912	9 - 12	30	35 - 75	M10	40	1 520,45
7120 29 1013	10 - 13	30	35 - 75	M10	40	1 520,45
7120 29 1317	13 - 17	50	35 - 75	M10	60	1 520,45
7120 29 1419	14 - 19	60	35 - 75	M10	75	1 533,10
7120 29 1621	16 - 21	60	35 - 75	M10	75	1 533,10
7120 29 1823	18 - 23	60	35 - 75	M10	100	1 638,15
7120 29 2025	20 - 25	60	35 - 75	M10	100	1 673,75
7120 29 2530	25 - 30	60	35 - 75	M10	110	1 701,75
7120 29 3037	30 - 37	70	35 - 75 60 - 130	M10	250	1 813,05
7120 29 3542	35 - 42	70	35 - 75 60 - 130	M10	250	1 854,45
7120 29 3845	38 - 45	70	35 - 75 60 - 130	M10	250	1 900,80
7120 29 4350	43 - 50	70	35 - 75 60 - 130	M10	400	1 1024,20

İç Rulman Çektirme Pensleri - Model B
Internal Expansion Puller - Model B

KOD CODE	øD mm	t mm	Kullanılan Kol / For	Adaptör vidası	g	TL/Ad.
7120 29 2540	25 - 40	45	35 - 75 60 - 130	M10	235	1 1137,35

İç Rulman Çektirme Kolları
Arms For Internal Expansion Puller

**Krom vanadyum, Çinko kaplı, Kollar sertleştirilmiş,
Mil indüksiyonda sertleştirilmiş**
*Chrom vanadium, Zinc plated,
Arms hardened, Spindle induction hardened*

KOD CODE	Kapasite Capacity mm	Kullanılan pensler / For	Adaptör vidası Screw Adapter	g	TL/Ad.
----------	----------------------	--------------------------	------------------------------	---	--------

7120 29 3575	35 - 75	Model A 5 - 7'den 43 - 50'ye Model B 25 - 40	M10	625	1 572,15
--------------	---------	--	-----	-----	----------

7120 29 6013	60 - 130	Model A 30 - 37'den 43 - 50'ye Model B 25 - 40	M10	1000	1 1159,30
--------------	----------	--	-----	------	-----------

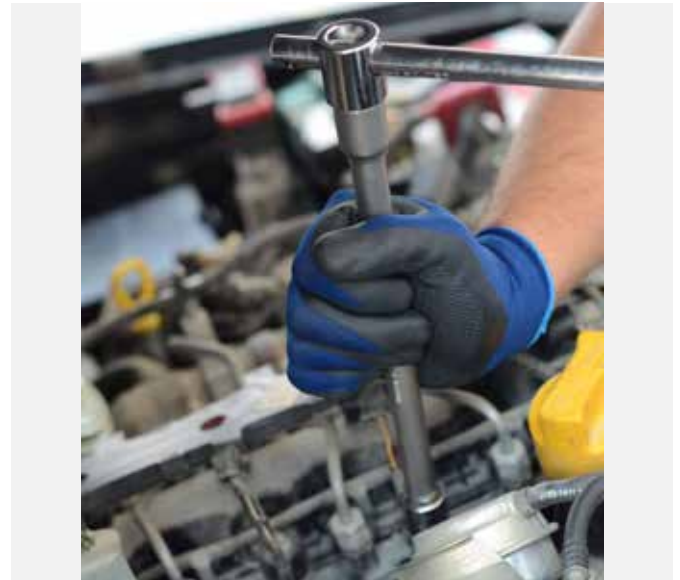

(*) İşaretili olan ürünler stoklarla sınırlıdır.

7122

Dış Rulman Çektirme Çeneleri Seperator



Krom vanadyum, Çinko kaplı, Kollar sertleştirilmiş,
Mil indüksiyonda sertleştirilmiş
Chrom vanadium, Zinc plated,
Arms hardened, Spindle induction hardened

KOD CODE	Ø mm	Kullanılan Kollar / For	Adaptör vidası	g	TL/Ad.
7122 29 0560	5 - 60	40 - 115	M12	370	1 868,45
7122 29 1275	12 - 75	40 - 115	M12	635	1 1087,95
7122 29 2211	22 - 115	55 - 205	M16	1780	1 1698,95
7122 29 2515	25 - 155	90 - 260	M20x1.5	3940	1 2659,45
7122 29 3022	30 - 220	100 - 360	M20x1.5	11000	1 7268,05
7122 29 4028	40 - 280	140 - 435	M24x3	15000	1 16233,30

7122

Dış Rulman Çektirme Kolları Puller Arms For Separator

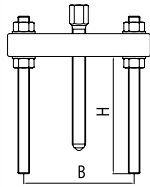

Krom vanadyum, Çinko kaplı, Kollar sertleştirilmiş,
Mil indüksiyonda sertleştirilmiş
Chrom vanadium, Zinc plated,
Arms hardened, Spindle induction hardened

KOD CODE	B mm	H mm	Kullanılan Çene / For	Adaptör vidası	g	TL/Ad.
7122 29 4011	40-115	150	5 - 60 12 - 75	M12	990	1 1618,60
7122 29 5520	55-205	210	22 - 115	M16	2700	1 2562,20
7122 29 9026	90-260	315	25 - 155	M20x1.5	4965	1 3627,50
7122 29 1036	100-360	305	30 - 220	M20x1.5	7000	1 7465,35
7122 29 1443	140-435	320	40 - 280	M24x3	11000	1 14591,25

7126

Rotil Çektirme Extractor For Ball Joint

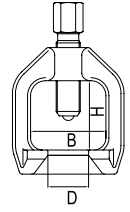

KOD CODE	ØD mm	B mm	H mm	g	TL/Ad.
7126 29 0018	18	40	40	315	1 486,95
7126 29 0025	25	50	50	540	1 667,55
7126 29 0029	29	60	60	915	1 887,95
7126 29 0040	40	80	80	1965	1 1253,65
7126 29 0045	45	90	100	2670	1 1582,75



(★) İşaretili olan ürünler stoklarla sınırlıdır.



IZELTAS®

elta

Anahtarlar
Wrenches

Tornavida ve Allen Anahtarlar
Screwdrivers and Hex Key Wrenches

Lokma Anahtarları
Sockets Wrenches

Keskiler
Chisels

Boru Anahtarları ve Penseler
Pipe Wrenches and Pliers

Makaslar
Shears

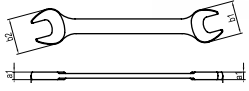

elta

0150
İki Ağız Anahtar (mm)
Double Ended Open Jaw Wrench (mm)

Krom vanadyum, Krom kaplı
Chrom vanadium, Chrom plated

KOD CODE	mm	L mm	a1 mm	b1 mm	b2 mm	g	TL/Ad.
0150 01 0607	6x7	98	3.3	13.5	15.5	10	18,85
0150 01 0809	8x9	108	3.6	17.5	19.5	20	19,15
0150 01 1011	10x11	120	4.1	21.5	23.5	30	20,75
0150 01 1213	12x13	134	4.5	25.5	27.5	40	23,00
0150 01 1415	14x15	150	5	29.5	31.5	60	26,65
0150 01 1617	16x17	163	5.5	33.5	35.5	85	30,85
0150 01 1819	18x19	178	6	37.5	39.5	110	33,10
0150 01 2022	20x22	198	6.5	41.5	45.5	145	37,60
0150 01 2123	21x23	218	6.9	43.5	47.5	175	41,00
0150 01 2426	24x26	236	7.4	49.5	53.5	235	47,05
0150 01 2528	25x28	250	7.8	51.5	57.5	275	56,45
0150 01 2732	27x32	265	8.3	55.5	65.5	345	67,40

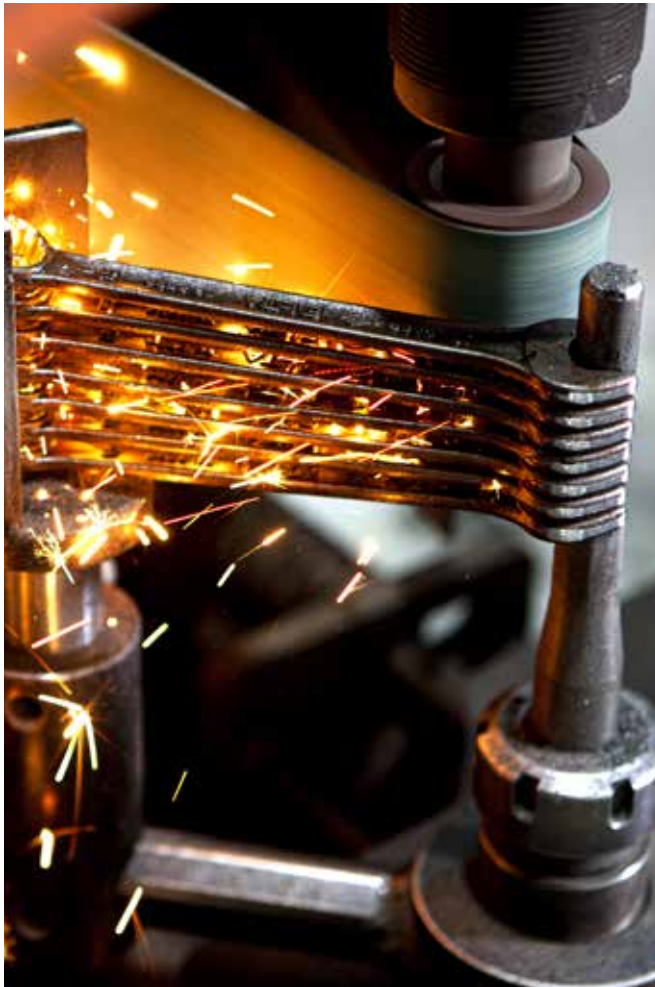
0150
İki Ağız Anahtar Takımı (mm)
Double Ended Open Jaw Wrench Set (mm)

KOD CODE	İÇERİK CONTENTS	g	TL/Ad.
0150 00 2108	6x7 - 8x9 - 10x11 12x13 - 14x15 - 16x17 18x19 - 20x22	560	8 209,95
0150 00 2112	6x7 - 8x9 - 10x11 12x13 - 14x15 - 16x17 18x19 - 20x22 - 21x23 24x26 - 25x28 - 27x32	1590	12 421,85

(★) İşaretili olan ürünler stoklarla sınırlıdır.

0350

Kombine Anahtar (mm) Combination Wrench (mm)



TS 3794
TS ISO 7738 Form A
DIN 3113

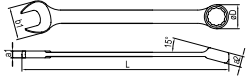

Krom vanadyum, Krom kaplı
Chrom vanadium, Chrom plated

0350

Kombine Anahtar Takımı (mm) Combination Wrench Set (mm)



KOD CODE	mm	L mm	a1 mm	a2 mm	b1 mm	øD mm	g	TL/Ad.	
0350 02 0006	6	95	3.1	5.1	13.5	10	15	10	24,60
0350 02 0007	7	104	3.3	5.5	15.5	11.5	15	10	26,15
0350 02 0008	8	112	3.7	5.9	17.5	13	20	10	28,25
0350 02 0009	9	121	3.9	6.3	19.5	14	25	10	29,25
0350 02 0010	10	130	4.3	6.9	21.5	15.5	30	10	32,90
0350 02 0011	11	138	4.5	7.3	23.5	16.5	35	10	33,95
0350 02 0012	12	146	4.9	7.7	25.5	18	45	10	36,20
0350 02 0013	13	154	5.1	8.1	27.5	19	50	10	36,75
0350 02 0014	14	163	5.5	8.7	29.5	21.5	60	10	39,65
0350 02 0015	15	171	5.7	9.1	31.5	22	70	10	42,50
0350 02 0016	16	180	6.1	9.5	33.5	23	85	10	45,60
0350 02 0017	17	189	6.3	9.9	35.5	25	95	10	48,85
0350 02 0018	18	200	6.7	10.4	37.5	26.5	110	10	54,15
0350 02 0019	19	211	6.9	11	39.5	28	130	10	57,10
0350 02 0020	20	222	7.3	11.4	41.5	29.5	145	10	58,15
0350 02 0021	21	235	7.3	11.4	43.5	31	160	10	67,60
0350 02 0022	22	250	8.1	12.6	45.5	32.5	200	10	77,25
0350 02 0024	24	270	8.7	13.6	49.5	36	250	5	94,30
0350 02 0027	27	300	9.6	14.8	55.5	40	350	5	111,15
0350 02 0030	30	330	10.2	15.8	61.5	44.5	445	5	127,55
0350 02 0032	32	350	10.4	16.2	65.5	47	500	5	133,70

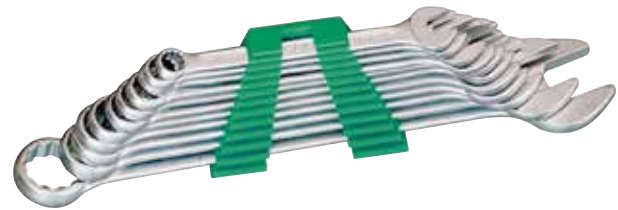

KOD CODE	İÇERİK CONTENTS	g	TL/Ad.	
0350 00 2108	6 - 7 - 8 - 9 - 10 - 13 17 - 19	395	8	283,85
0350 00 2112	8 - 9 - 10 - 11 - 12 13 - 14 - 15 - 16 17 - 19 - 22	855	12	508,25
0350 00 2117	6 - 7 - 8 - 9 - 10 11 - 12 - 13 - 14 15 - 16 - 17 - 18 19 - 20 - 21 - 22	1300	17	738,90
0350 00 2121	6 - 7 - 8 - 9 - 10 11 - 12 - 13 - 14 15 - 16 - 17 - 18 19 - 20 - 21 - 22 24 - 27 - 30 - 32	2810	21	1205,60

(★) İşaretili olan ürünler stoklarla sınırlıdır.

0450

Yıldız İki Ağız Anahtar (mm) Double Ended Ring Wrench (mm)



TS 3794
TS ISO 10104 Form B
DIN 838

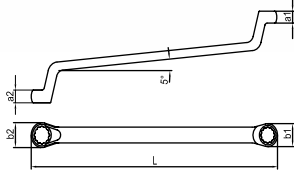

Krom vanadyum, Krom kaplı
Chrom vanadium, Chrom plated

KOD CODE	mm	L mm	a1 mm	a2 mm	b1 mm	b2 mm	g		TL/Ad.
0450 03 0607	6x7	140	4.8	5.2	11	12	45	10	42,45
0450 03 0809	8x9	158	5.4	5.8	13.5	14.5	60	10	42,95
0450 03 1011	10x11	175	6	6.4	16	17.5	90	10	47,70
0450 03 1213	12x13	193	6.6	7.1	19	20	100	10	53,90
0450 03 1415	14x15	210	7.7	8.1	21.5	23.5	140	10	56,60
0450 03 1617	16x17	230	9.2	9.6	25.5	26.5	190	10	64,00
0450 03 1819	18x19	246	10.2	10.6	27.5	29.5	240	10	76,50
0450 03 2022	20x22	280	11.2	11.8	31	34	255	5	83,75
0450 03 2123	21x23	284	11.4	12.2	32.5	35	300	5	96,00
0450 03 2426	24x26	300	12.6	13.2	37	39	335	5	111,75
0450 03 2528	25x28	314	13.6	14.2	38	42	430	5	122,50
0450 03 2732	27x32	329	14.8	15.2	41	49	525	5	134,85

0450

Yıldız İki Ağız Anahtar Takımı (mm) Double Ended Ring Wrench Set (mm)

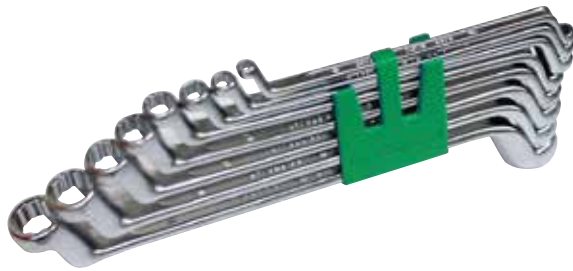

KOD CODE	İÇERİK CONTENTS	g		TL/Ad.
0450 00 2108	6x7 - 8x9 - 10x11 12x13 - 14x15 - 16x17 18x19 - 20x22	1120	8	467,85
0450 00 2112	6x7 - 8x9 - 10x11 12x13 - 14x15 - 16x17 18x19 - 20x22 - 21x23 24x26 - 25x28 - 27x32	2710	12	932,95

0601

Kurbağacak Anahtar Adjustable Wrench

TS 3796
DIN 3117

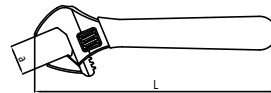

Krom vanadyum, Krom kaplı, PVC izoleli
Chrom vanadium, Chrom plated, PVC Insulated

KOD CODE	L mm	L inch	a mm	g		TL/Ad.
0601 01 0008	206	8"	23	240	5	146,50
0601 01 0010	256	10"	28	400	5	220,55
0601 01 0012	306	12"	34	650	5	291,45

1115

1/2" Altı Köşe Lokma Anahtar (mm) Socket Wrench 6 Points (mm)

TS ISO 2725
DIN 3124



1/2"

Krom vanadyum, Krom kaplı
Chrom vanadium, Chrom plated

KOD CODE	mm	Ø D1 mm	Ø D2 mm	L mm	L1 mm	g	TL/Ad.	
1115 06 0010	10	15.4	22	38	8	60	10	31,25
1115 06 0011	11	16.6	22	38	8	60	10	31,25
1115 06 0012	12	17.9	22	38	9	60	10	31,25
1115 06 0013	13	19	22	38	10	60	10	32,35
1115 06 0014	14	20.4	22	38	11	60	10	32,35
1115 06 0015	15	21.6	22	38	11	65	10	32,35
1115 06 0016	16	22.9	22	38	11	70	10	33,75
1115 06 0017	17	24.1	22	38	12	70	10	33,75
1115 06 0018	18	25.4	23	38	13	75	10	33,75
1115 06 0019	19	26.6	23	38	13	75	10	36,25
1115 06 0020	20	28	24	38	13	80	10	36,25
1115 06 0021	21	29.2	24	38	13	80	5	36,25
1115 06 0022	22	30.4	26	38	15	95	5	36,25
1115 06 0023	23	31.2	28	38	15	100	5	39,40
1115 06 0024	24	33	28	38	17	115	5	39,40
1115 06 0026	26	34	30	42	17	130	5	44,25
1115 06 0027	27	36.6	30	42	19	140	5	50,35
1115 06 0028	28	37.5	30	42	20	160	5	53,00
1115 06 0030	30	40	32	44	21	175	5	53,00
1115 06 0032	32	43	34	44	23	180	5	56,65

1514

1/2" T Kol Sliding T - Handle

TS ISO 3315
DIN 3122



1/2"

Krom vanadyum, Krom kaplı
Chrom vanadium, Chrom plated

KOD CODE	L mm	g	TL/Ad.
1514 06 4025	250	370	117,30

1514

1/2" T Kol Adaptörü Adapter



1/2"

Krom vanadyum, Krom kaplı
Chrom vanadium, Chrom plated

KOD CODE	inch	g	TL/Ad.
1514 06 6250	3/8"Fx1/2"M	90	67,15

1514

1/2" Ara Kol Extension Bar

TS ISO 3316
DIN 3123



1/2"

Krom vanadyum, Krom kaplı
Chrom vanadium, Chrom plated

KOD CODE	L mm	g	TL/Ad.
1514 06 4125	125	220	61,45
1514 06 4250	250	425	106,60

1514

1/2" Mafsal Universal Joint

TS ISO 3316
DIN 3123



1/2"

Krom vanadyum, Krom kaplı
Chrom vanadium, Chrom plated

KOD CODE	L mm	g	TL/Ad.
1514 06 4065	65	140	81,65

1514

1/2" Cırcır Kolu
Ratchet Handle

TS ISO 3315
DIN 3122



Krom vanadyum, Krom kaplı
Chrom vanadium, Chrom plated

1/2"

KOD CODE	L mm	g	TL/Ad.
1514 06 5250	250	585	249,85

1115

1/2" Altı Köşe Lokma Anahtar Takımı (17 Parça, mm)
Socket Wrench Set 6 Points (17 pcs, mm)

1115

1/2" Altı Köşe Lokma Anahtar Takımı (24 Parça, mm)
Socket Wrench Set 6 Points (24 pcs, mm)



1/2"

1/2"

KOD CODE	LOKMALAR Sockets	AVADANLIKLAR Accessories	g	TL/Ad.
1115 00 2017		1/2" Cırcır Kolu Ratchet Handle	2650	17
		1/2" T Kol Adaptör Sliding T Handle Adapter		
		1/2" Mafsıl Universal Joint		
	10 - 11 - 12 13 - 14 - 15 17 - 19 - 22 24 - 27 - 30 32	1/2" Ara Kol Extension Bar 250 mm		

KOD CODE	LOKMALAR Sockets	AVADANLIKLAR Accessories	g	TL/Ad.
1115 00 2024		1/2" Cırcır Kolu Ratchet Handle	3485	24
		1/2" Mafsıl Universal Joint		
		1/2" T Kol Adaptör Sliding T Handle Adapter		
	10 - 11 - 12 13 - 14 - 15 16 - 17 - 18 19 - 21 - 22 23 - 24 - 26 27 - 28 - 30 - 32	1/2" Ara Kol Extension Bar 125 mm		
		1/2" Ara Kol Extension Bar 250 mm		

Havali aletler ile kullanmayınız / Do not use with power-tools

(★) İşaretili olan ürünler stoklarla sınırlıdır.

2203

Maşalı Boru Anahtarı (85°)
Pipe Wrench (85°)

DIN 5234

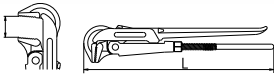

Krom vanadyum, Dişler induksiyonda sertleştirilmiş, Elektrostatik boyanmış
Chrom vanadium, Teeth induction hardened, Electrostatically painted

KOD CODE	L mm	mm	inch	g		TL/Ad.
2203 10 0010	325	37	1"	760	1	246,15
2203 10 0015	430	43	1 1/2"	1360	1	378,30
2203 10 0020	585	49	2"	2350	1	564,10
★2203 10 0030	690	55	3"	3200	1	851,20

2401

Fort Pense
Waterpump Pliers

TS 60
TS ISO 8976
DIN 8976

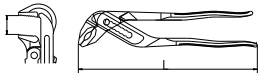

Krom vanadyum, Nikel kaplı, PVC izoleli
Chrom vanadium, Nickel plated, PVC Insulated

KOD CODE	L mm	L inch	mm	g		TL/Ad.
2401 11 0240	240	9 1/2"	35	375	5	232,40

2509

Ayarlı Pense
Grip

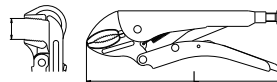

Çeneler krom vanadyum çeliğinden dövülmüştür, Nikel kaplama,
Kullanım sahası: Yuvarlak ve düz malzemeler
Jaws Chrom vanadium forged, Nickel plated
Application field : Flat and round materials

KOD CODE	L mm	L inch	mm	g		TL/Ad.
2509 11 0225	225	9"	30	470	5	224,05

(★) İşaretili olan ürünler stoklarla sınırlıdır.

3021

Kombine Pense Opak Seri Combination Pliers

TS 60
DIN ISO 5746



Özel alaşımli çelik, Kesici ağızlar indüksiyonda sertleştirilmiş, PVC saplı
Special steel, Cutters induction hardened, PVC handle

KOD CODE	L mm	L inch	g	□	TL/Ad.
3021 12 1160	160	6 1/4"	200	5	120,10
3021 12 1180	180	7 1/8"	250	5	146,95
3021 12 1200	200	8"	310	5	179,15

3221

Kargaburun Düz Uçlu Opak Seri Long Nose Pliers (Flat)

TS 60
TS ISO 5745



Özel alaşımli çelik, Kesici ağızlar indüksiyonda sertleştirilmiş, PVC saplı
Special steel, Cutters induction hardened, PVC handle

KOD CODE	L mm	L inch	g	□	TL/Ad.
3221 13 1160	160	6 1/4"	145	5	130,35
3221 13 1200	200	8"	190	5	149,20

3701

Yan Keski Opak Seri Side Cutting Pliers

TS 60
TS ISO 5749
DIN 5749



Özel alaşımli çelik, Kesici ağızlar indüksiyonda sertleştirilmiş, PVC saplı
Special steel, Cutters induction hardened, PVC handle

KOD CODE	L mm	L inch	g	□	TL/Ad.
3701 16 1140	140	5 1/2"	160	5	114,05
3701 16 1160	160	6 1/4"	220	5	134,00

3801

Kerpeten Carpenter Pincers

TS 60
TS ISO 9243
DIN ISO 9243



Özel alaşımli çelik, Kesici ağızlar indüksiyonda sertleştirilmiş, Vernikli, PVC izoleli
Special steel, Cutters induction hardened, Lacquered, PVC Insulated

KOD CODE	L mm	L inch	g	□	TL/Ad.
3801 15 0160	160	6 1/4"	235	5	130,60
3801 15 0180	180	7 1/8"	245	5	141,05
3801 15 0200	200	8"	390	5	176,35

3832

Betoncu Kerpeteni Tower Pincers

TS 60
TS ISO 9242
DIN ISO 9242



Özel alaşımli çelik, Kesici ağızlar indüksiyonda sertleştirilmiş, Vernikli, PVC izoleli
Special steel, Cutters induction hardened, Lacquered, PVC insulated

KOD CODE	L mm	L inch	g	□	TL/Ad.
3832 15 0225	225	9"	335	5	168,00
3832 15 0250	250	10"	415	5	191,45
3832 15 0280	280	11"	475	5	229,60

4170

Değişken Uçlu Tornavida Screwdriver - Reversible

TSEK



Krom vanadyum, Krom kaplı, PP saplı
Chrom vanadium, Chrom plated, PP handle

KOD CODE	ØDxL1 mm	axb mm	+	L mm	g	□	TL/Ad.
4170 17 0680	6x80	1.2x6	Ph2	180	60	10	48,85

(★) İşaretili olan ürünler stoklarla sınırlıdır.

4150

Opak Seri Düz Uçlu Tornavida Screwdriver, Opak, Flat

TS ISO 2380 - 1
DIN ISO 2380-1

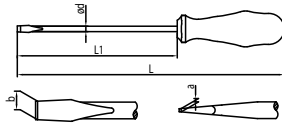

Krom vanadyum, Krom kaplı, PP saplı
Chrom vanadium, Chrom plated, PP handle

KOD CODE	øDxL1 mm	-		L mm	g	□	TL/Ad.
		a mm	b mm				
4150 17 0380	3x80	0.5	3	150	20	10	21,20
4150 17 0480	4x80	0.8	4	170	30	10	24,45
4150 17 4100	4x100	0.8	4	190	40	10	26,10
4150 17 5100	5x100	1.0	5.5	200	55	10	31,45
4150 17 5125	5x125	1.0	5.5	225	60	10	36,25
4150 17 6100	6x100	1.2	6.5	200	70	10	32,70
4150 17 6125	6x125	1.2	6.5	225	75	10	37,15
4150 17 6150	6x150	1.2	6.5	250	80	10	41,00
4150 17 7150	7x150	1.2	8	260	110	10	48,00
4150 17 8150	8x150	1.6	10	260	130	10	51,95
4150 17 8175	8x175	1.6	10	285	135	10	58,25

4170

Opak Seri Yıldız Uçlu Tornavida Screwdriver, Opak Phillips

TS 59 - 5 ISO 8764
DIN ISO 8764

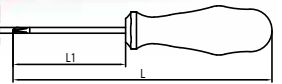
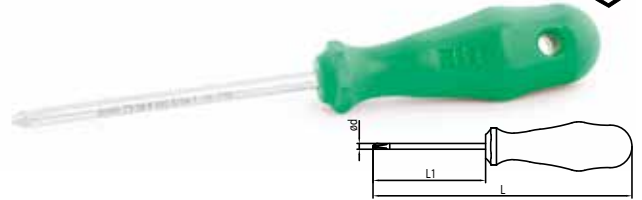

Krom vanadyum, Krom kaplı, PP saplı
Chrom vanadium, Chrom plated, PP handle

KOD CODE	øDxL1 mm	+	L mm	g	□	TL/Ad.
4170 18 4580	4.5x80	Ph1	170	45	10	32,35
4170 18 6100	6x100	Ph2	200	70	10	38,95
4170 18 8150	8x150	Ph3	260	130	10	73,60

4150

Opak Seri Tornavida Seti (6 parça) Screwdriver Set, Opak (6 Pcs)



KOD CODE	İÇERİK CONTENTS	g	□	TL/Ad.
4150 00 8106	4x80 - 5x100 - 6x125	545	6	212,35
	7x150			
	4.5x80 - 6x100			
	Düz uçlu / Flat			
	Yıldız uçlu / Phillips			

4150

Opak Seri Tornavida Seti (7 parça) Screwdriver Set, Opak (7 Pcs)



KOD CODE	İÇERİK CONTENTS	g	□	TL/Ad.
4150 00 8107	3x80 - 4x100 - 5x125	605	7	254,10
	6x150 - 8x175			
	4.5x80 - 6x100			
	Düz uçlu / Flat			
	Yıldız uçlu / Phillips			

(*) İşaretili olan ürünler stoklarla sınırlıdır.

4908

Allen Anahtar Altı Köşe (mm)
Hex Key Wrench (mm)

TS ISO 2936
DIN ISO 2936



Krom vanadyum, Siyah Oksit Kaplı
Chrom vanadium, Black finish

KOD CODE	mm	L mm	L1 mm	g		TL/Ad.
4908 22 0015	1.5	45	14	1.5	10	2,85
4908 22 0020	2	50	16	2	10	3,60
4908 22 0025	2.5	56	18	4	10	4,30
4908 22 0030	3	63	20	6	10	4,95
4908 22 0035	3.5	66	22	8	10	5,70
4908 22 0040	4	70	25	10	10	6,60
4908 22 0050	5	80	28	20	10	6,90
4908 22 0060	6	90	32	30	10	9,55
4908 22 0070	7	95	36	40	10	13,50
4908 22 0080	8	100	36	55	10	15,65
4908 22 0090	9	105	38	75	10	22,15
4908 22 0100	10	112	40	100	10	23,80
4908 22 0120	12	125	45	160	10	34,80

4908

Allen Anahtar Takım Altı Köşe (mm)
Hex Key Wrench Set (mm)

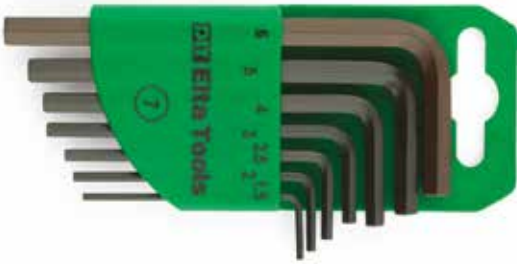

KOD CODE	İÇERİK CONTENTS	g		TL/Ad.
4908 00 3107	1.5 - 2 - 2.5 - 3 - 4 - 5 - 6	80	7	38,75
4908 00 3109	1.5 - 2 - 2.5 - 3 - 4 5 - 6 - 8 - 10	235	9	78,20
4908 00 3110	1.5 - 2 - 2.5 - 3 - 4 - 5 6 - 8 - 10 - 12	395	10	113,00

4922

T Tipi Allen Anahtar (mm)
Hex Key Wrench T - Handle (mm)

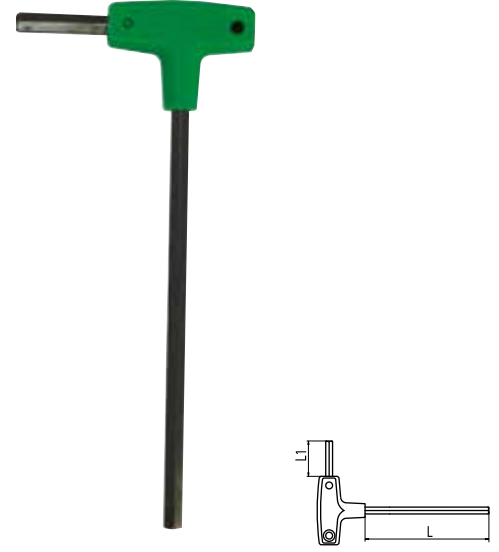

Krom vanadyum, Siyah Oksit Kaplı, PP saplı
Chrom vanadium, Black finish, PP handle

KOD CODE	mm	L mm	L1 mm	g		TL/Ad.
4922 22 0025	2.5	110	14	15	5	39,15
4922 22 0030	3	125	18	20	5	39,30
4922 22 0040	4	140	22	30	5	39,70
4922 22 0050	5	155	26	55	5	45,05
4922 22 0060	6	170	30	75	5	49,45
4922 22 0070	7	185	34	115	5	51,15
4922 22 0080	8	200	38	150	5	61,65
4922 22 0100	10	220	48	270	5	107,65

4922

T Tipi Allen Anahtar Takımı (8 Parça, mm)
Hex Key Wrench T - Handle Set (8 Pcs, mm)



KOD CODE	İÇERİK CONTENTS	g		TL/Ad.
4922 00 8108	2.5 - 3 - 4 - 5 6 - 7 - 8 - 10	730	8	433,10

(★) İşaretli olan ürünler stoklarla sınırlıdır.

4915

Kaset Allen Anahtar Takımı (6 Parça, mm)
Hex Key Wrench Folding Set (6 Pcs, mm)



Krom vanadyum, Siyah oksid kaplı
Chrom vanadium, Black finish

KOD CODE	İÇERİK CONTENTS	g	TL/Ad.
4915 00 6106	2.5 - 3 - 4 - 5 - 6 - 8	175	1

5011

Iskarpela (Düz)
Wood Chisel

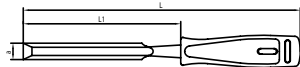

Özel alaşımlı çelik, Uç induksiyonda sertleştirilmiş, PP Saplı
Special steel, induction hardened tips, PP Handle

KOD CODE	a mm	L mm	L1 mm	g	TL/Ad.	
5011 23 0006	6	245	120	105	5	72,50
5011 23 0008	8	245	122	125	5	76,75
5011 23 0010	10	245	124	140	5	81,20
5011 23 0012	12	245	126	140	5	89,05
5011 23 0014	14	245	128	145	5	92,15
5011 23 0016	16	255	130	165	5	98,45
5011 23 0018	18	255	132	165	5	106,90
5011 23 0020	20	255	134	165	5	118,60
5011 23 0022	22	255	136	180	5	128,85
5011 23 0024	24	255	138	205	5	138,90
5011 23 0026	26	255	140	205	5	144,15
5011 23 0030	30	260	150	205	5	153,70

5884

Plastik Şerit Metre
Plastic Measuring tapes



KOD CODE	ÖLÇÜ SIZE	g	TL/Ad.	
5884 26 0003	3	95	5	32,85
5884 26 0005	5	195	5	47,35

5891

Testere Kolu
Hacksaw Frame

DIN 6473



KOD CODE	L mm	g	TL/Ad.	
5891 26 0830	300	345	5	117,35

6351

Levye Oluklu
Tyre Lever, Straight

TSEK



Krom vanadyum, Krom kaplı
Chrom vanadium, Chrom plated

KOD CODE	L mm	L inch	g	TL/Ad.	
6351 26 0400	400	16"	435	5	90,45
6351 26 0500	500	20"	680	5	132,55
6351 26 0600	600	24"	970	5	172,75

(★) İşaretili olan ürünler stoklarla sınırlıdır.

6730

Çim Kesme Makası (Düz Ağız)
Grass Shears (Straight)



KOD CODE	L mm	L inch	g	TL/Ad.
6730 27 0550	550	21 5/8"	915	5 204,95

6722

Bağ Makası (Hafif Tip)
Pruning Shears (Light)



Alüminyum gövde, Daldırma PVC izoleli
Aluminum forged body, PVC dipped

KOD CODE	L mm	L inch	g	TL/Ad.
6722 27 0220	220	8 5/8"	240	5 223,90

6731

Çim Kesme Makası (Eğri Ağız)
Grass Shears (Wave Edges)



KOD CODE	L mm	L inch	g	TL/Ad.
6731 27 0650	650	25 5/8"	1195	5 366,30

8011

Teşhir Panosu
Display



6721

Bağ Makası (Lüks)
Pruning Shears (Lux)



Özel alaşımli çelik, Kesici ağızlar induksiyonda sertleştirilmiş, PVC izoleli
Special steel, Cutters induction hardened, PVC dipped

KOD CODE	L mm	L inch	g	TL/Ad.
6721 27 0205	205	8"	290	5 155,15

KOD CODE	SIZE mm	Cinsi	g	TL/Ad.
8011 31 6001	500x1000x2250	Boş	14000	1 2594,60

(*) İşaretli olan ürünler stoklarla sınırlıdır.

IZELTAS®

YEDEK PARÇALAR

SPARE PARTS

Yedek Parçalar
Spare Parts



Kurbağacak Anahtar ve Ayarlı Montaj Anahtarları Yedek Parçalar Adjustable Wrench, Spare Parts

	KOD CODE	L mm	L inch	g	TL/ Ad.
Somun Nut	0600 01 0206	160	6"	5	10 12,50
	0600 01 0208	208	8"	10	10 14,80
	0600 01 0210	260	10"	10	10 19,75
	0600 01 0212	308	12"	20	10 27,00
	0600 01 0215	388	15"	65	10 38,95
Vida Bolt	0600 01 0306	160	6"	3	10 3,00
	0600 01 0308	208	8"	5	10 4,75
	0600 01 0310	260	10"	5	10 5,90
	0600 01 0312	308	12"	10	10 7,80
	0600 01 0315	388	15"	20	10 9,90
Yay Spring	0600 01 0406	160	6"	1	10 2,25
	0600 01 0408	208	8"	1	10 2,25
	0600 01 0410	260	10"	1	10 2,25
	0600 01 0412	308	12"	1	10 2,25
	0600 01 0415	388	15"	3	10 2,25

2100

Stilson Anahtar Yedek Parçaları Stilson Wrench Spare Part

	KOD CODE	ÖLÇÜ FOR	g	TL/ Ad.
Çene Jaw	2100 10 0108	8"	80	5 87,95
	2100 10 0110	10"	180	5 130,30
	2100 10 0112	12"	320	5 145,40
	2100 10 0114	14"	400	5 175,30
	2100 10 0118	18"	575	5 235,75
	2100 10 0124	24"	980	5 337,65
	Bağlantı Parçası Connection Part	2100 10 0208	8"	60
2100 10 0210		10"	95	5 200,20
2100 10 0212		12"	100	5 219,35
2100 10 0214		14"	195	5 264,85
2100 10 0218		18"	345	5 303,50
2100 10 0224		24"	445	5 453,70
Somun Nut		2100 10 0308	8"	10
	2100 10 0310	10"	30	5 72,05
	2100 10 0312	12"	25	5 75,25
	2100 10 0314	14"	45	5 83,95
	2100 10 0318	18"	75	5 116,00
	2100 10 0324	24"	105	5 126,80



2110

Ağır Tip Boru Anahtarları Yedek Parçaları Pipe Wrench, Heavy Duty Spare Parts

	KOD CODE	ÖLÇÜ FOR	g	TL/ Ad.	
Çene Jaw	2110 10 0108	8"	100	5 194,45	
	2110 10 0110	10"	205	5 236,35	
	2110 10 0112	12"	235	5 466,30	
	2110 10 0114	14"	400	5 497,40	
	2110 10 0118	18"	675	5 528,50	
	2110 10 0124	24"	900	5 792,75	
	2110 10 0136	36"	1820	5 1585,25	
	2110 10 0148	48"	3410	5 2610,90	
	Somun Nut	2110 10 0308	8"	10	5 63,90
		2110 10 0310	10"	25	5 67,00
2110 10 0312		12"	35	5 73,15	
2110 10 0314		14"	40	5 88,80	
2110 10 0318		18"	65	5 118,25	
2110 10 0324		24"	115	5 180,35	
2110 10 0336		36"	230	5 334,30	
2110 10 0348		48"	305	5 536,35	
Alt Çene ve Pim Lower Jaw and Pin		2110 10 0408	8"	15	5 204,75
		2110 10 0410	10"	40	5 227,05
	2110 10 0412	12"	60	5 255,85	
	2110 10 0414	14"	60	5 263,90	
	2110 10 0418	18"	90	5 273,25	
	2110 10 0424	24"	125	5 300,65	
	2110 10 0436	36"	225	5 479,65	
	2110 10 0448	48"	285	5 647,50	

2201

Maşalı Boru Anahtarları Yedek Somun Nut

	KOD CODE	ÖLÇÜ FOR	g	TL/ Ad.
Maşalı Boru Anahtarları Yedek Somun Nut	2201 10 0110	1"	25	10 15,00
	2201 10 0115	1 1/2"	40	10 18,90
	2201 10 0120	2"	60	10 25,15
	2201 10 0130	3"	75	10 33,70
	2201 10 0140	4"	75	10 39,60

2350

Demir Kesme Makası Yedek Bolt Cutters Spare Part

Çene Jaw



	KOD CODE	ÖLÇÜ SIZE	KAPASİTE CAPACITY Ø mm	g	TL/ Ad.
Demir Kesme Makası Yedek Bolt Cutters Spare Part	2350 27 0118	18"	6 - 8	850	1 331,75
	2350 27 0124	24"	8 - 10	870	1 380,25
	2350 27 0130	30"	9 - 13	1250	1 673,10
	2350 27 0136	36"	11 - 16	1850	1 1242,85

(★) İşaretli olan ürünler stoklarla sınırlıdır.

5850

Plastik Çekiç Yedek Başlık Plastic Hammer Spare Head



KOD CODE	ØD mm	g	TL/Ad.
5850 25 0130	30	35	10 31,35
5850 25 0140	40	70	10 44,75
5850 25 0150	50	120	10 64,10

6400

Keser Yedek Sapı / Adze Handle



KOD CODE	L mm	g	TL/Ad.
6400 25 0001	400	140	10 40,60

5800

Tesviyeci Çekiç Yedek Sapı (Kamalı) Hammer Handle (With Pin)



KOD CODE	L mm	g	g	TL/Ad.
5800 25 0001	260	100	60	10 32,30
5800 25 0002	280	200	60	10 32,35
5800 25 0003	300	300	95	10 36,20
5800 25 0005	320	500	100	10 40,60
5800 25 0010	360	1000	165	10 52,70
5800 25 0015	380	1500	185	10 59,35
5800 25 0020	400	2000	205	10 63,95

5865

Madırğa Yedek Sap (Kamalı) Mallet Handle (With Pin)



KOD CODE	L mm	g	g	TL/Ad.
5865 25 0001	260	1000	210	10 38,05
5865 25 0002	280	1500	270	10 41,75

6410

Nacak Yedek Sap (Kamalı) Hatchet Handle (With Pin)



KOD CODE	L mm	g	g	TL/Ad.
6410 25 0001	380	800	250	10 122,90

03755

Kablo Sıyrıcı Yedek Bıçağı Cable Strippers Spare Blade



KOD CODE	ÖLÇÜ SİZE	g	TL/Ad.
03755 50 625	Tek 6/300 Çok 1,5/25	25	5 44,75

06375

Ayarlı Yağ Filtresi Sökeceği Yedek Kelepçe Adjustable Slot Type Oil Filter Wrench Spare Clamp



KOD CODE	Ø mm	g	TL/Ad.
06375 50 010	65-110	20	5 36,25



(*) İşaretili olan ürünler stoklarla sınırlıdır.

6230

Gres Pompası Yedek Ucu
Grease Gun Nozzle



500cc
300cc

KOD CODE	L mm	Ø mm	g	TL/Ad.
6230 26 2500	38	15	31	10
				30,60

Hortumu
Hose for
Grease Gun



KOD CODE	Ø mm	L mm	g	TL/Ad.
6230 26 3300	8	300	34	10
6230 26 3500	12	500	102	10
				34,85
				64,05

05898

HSS Testere Laması
Hacksaw Blade HSS



KOD CODE	ÖLÇÜ SIZE	g	TL/Ad.
05898 50 283	13x0.65x18	20	100
			30,70

05899

Bimetal Testere Laması
Hacksaw Blade Bimetal



KOD CODE	ÖLÇÜ SIZE	g	TL/Ad.
05899 50 283	13x0.65x18	20	100
			36,00

6735

Dal Budama Testeresi Yedek Bıçak
Spare Blade for Pruning Saw



KOD CODE	L mm	g	TL/Ad.
6735 27 1300	300	60	5
			271,00

06765

Plastik Boru Kesme Makası Bıçağı
Plastic Pipe Cutter Spare Blade



KOD CODE	ÖLÇÜ SIZE	g	TL/Ad.
06765 50 042	42	73	5
06765 50 063	63	105	5
			430,45
			799,60

6850

Mini Boru Kesici Bıçağı / Blade For Mini Tube Cutter
Standart Boru Kesici Bıçağı / Blade For Standard Tube Cutter
Teleskopik Boru Kesici Bıçağı / Blade For Telescopic Tube Cutter



KOD CODE	ÖLÇÜ SIZE	g	TL/Ad.
6850 28 1322	1/4" - 1 3/8"	5	10
			48,05

6865

Profesyonel Boru Kesici Bıçağı
Blade For Professional Tube Cutter



KOD CODE	ÖLÇÜ SIZE	g	TL/Ad.
6865 28 0150	1/8" - 2"	30	5
			99,70



(*) İşaretli olan ürünler stoklarla sınırlıdır.

7010-7020

Standart Çektirme Yedek Parçaları Spare Parts For Standard Pullers

Uzatma Parçası / Connection Part, Extention



KOD CODE	L mm	KULLANILAN ÇEKTİRME FOR	g	TL/Ad.
7010 29 2033	200	8x10 - 12x10	415	1 146,60
7010 29 3033	300	16x15 - 20x15	890	1 255,15
7010 29 4033	400	25x20 - 35x20 37x20 - 52x20	2350	1 377,45

Kol / Arm



KOD CODE	L mm	KULLANILAN ÇEKTİRME FOR	g	TL/Ad.
7010 29 0822	8x10 - 12x10	110	1	110,30
7010 29 1622	16x15 - 20x15	330	1	191,90
7010 29 2522	25x20 - 35x20 52x20 - 37x20	775	1	336,35

Bağlantı Parçası / Connection Part



KOD CODE	L mm	KULLANILAN ÇEKTİRME FOR	g	TL/Ad.
7010 29 0833	8x10 - 12x10	160	1	55,60
7010 29 1633	16x15 - 20x15	325	1	96,05
7010 29 2533	25x20 - 35x20 52x20 - 37x20	930	1	168,20

Mil / Spindle



KOD CODE	L mm	KULLANILAN ÇEKTİRME FOR	g	TL/Ad.
7010 29 0844	8x10 - 12x10	185	1	100,85
7010 29 1644	16x15 - 20x15	555	1	192,65
7010 29 2544	25x20	1400	1	331,45
7010 29 3544	35x20 - 37x20	2185	1	431,85
7010 29 5244	52x20	3210	1	431,85

7030-7040

Master Çektirme Yedek Parçaları/Spare Parts For Master Puller

Kol / Arm



KOD CODE	KULLANILAN ÇEKTİRME FOR	g	TL/Ad.
7030 29 0822	8x8	110	1 60,25
7030 29 1222	12x12	215	1 83,65
7030 29 1622	16x16	345	1 149,45
7030 29 2322	23x20	580	1 203,30

Mil/Spindle



KOD CODE	KULLANILAN ÇEKTİRME FOR	g	TL/Ad.
7030 29 0844	8x8	180	1 81,95
7030 29 1244	12x12	360	1 120,60
7030 29 1644	16x16	680	1 133,20
7030 29 2344	23x20	1230	1 182,50

7050-7060

Batarya Çektirme Yedek Parçaları Spare Parts For Battery Pullers

Kol / Arm



KOD CODE	KULLANILAN ÇEKTİRME FOR	g	TL/Ad.
7050 29 0422	6x4	40	1 47,00
7050 29 0622	6x6	50	1 52,45
7050 29 0822	8x8	110	1 60,25

Mil / Spindle



KOD CODE	KULLANILAN ÇEKTİRME FOR	g	TL/Ad.
7050 29 0444	6x4	95	1 69,80
7050 29 0644	6x6	105	1 78,05
7050 29 0844	8x8	200	1 98,30

7070-7080

S Tipi Çektirme Yedek Parçaları Spare Parts For S Type Puller

Kol / Arm



KOD CODE	KULLANILAN ÇEKTİRME FOR	g	TL/Ad.
7070 29 2022	20x13	405	1 120,80

Mil / Spindle



KOD CODE	KULLANILAN ÇEKTİRME FOR	g	TL/Ad.
7070 29 2044	20x13	520	1 168,40

7090-7100

Üniversal Çektirme Yedek Parçaları Spare Parts For Universal Puller

Kol / Arm



KOD CODE	KULLANILAN ÇEKTİRME FOR	g	TL/Ad.
7090 29 2322	22x22	690	1 134,20

Mil / Spindle



KOD CODE	KULLANILAN ÇEKTİRME FOR	g	TL/Ad.
7090 29 2244	22x22	565	1 177,30



(*) İşaretili olan ürünler stoklarla sınırlıdır.



IZELTAS®

TİCARİ TEŞHİR ÜRÜNLERİ

COMMERCIAL DISPLAY PRODUCTS

Ticari Teşhir Ürünleri
Commercial Display Products

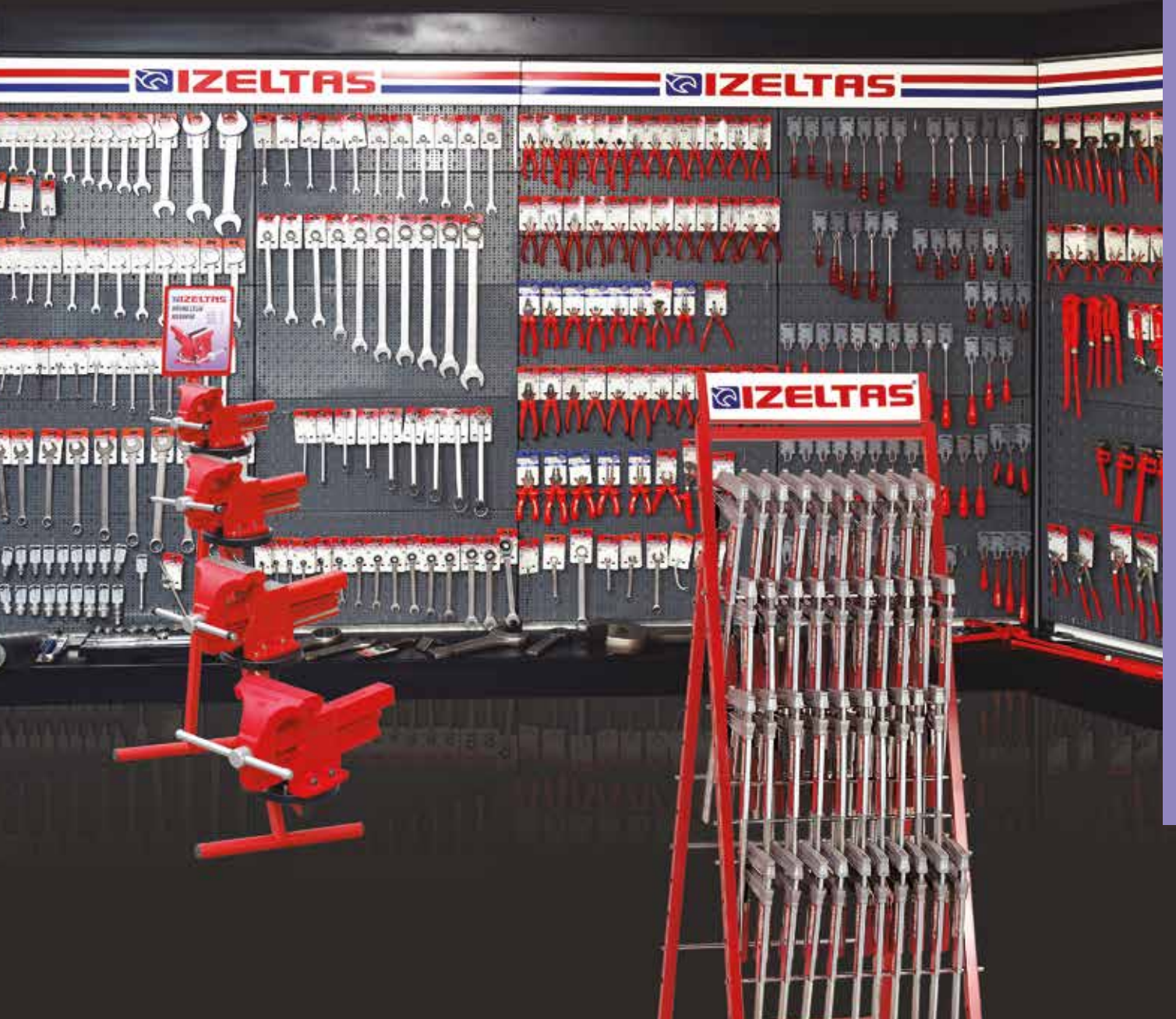

COMMERCIAL
DISPLAY STANDS

TİCARİ TEŞHİR
STANDLARI

1113

1/2" Lokma Anahtar Sehpa
Display Frame for Sockets

**1/2"**

KOD CODE	ÖLÇÜ SIZE mm	g	TL/Ad.
1113 31 6100	175x360x605	5800	1 783,85

2350

Demir Kesme Makası Sehpa
Display Frame for Bolt Cutters

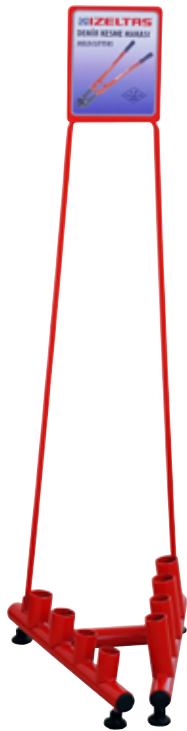

KOD CODE	İÇERİK CONTENTS	g	TL/Ad.
2350 31 6104	Boş - Empty	7400	1 1081,10

7010

Çektirme Sehpa
Display Frame For Pullers



KOD CODE	İÇERİK CONTENTS	g	TL/Ad.
7010 31 6105	Boş - Empty	2000	1 227,05

7300

İşkence Sehpa
Display Frame for Screw Clamps



KOD CODE	ÖLÇÜ SIZE mm	g	TL/Ad.
7300 31 6150	100x520x1420	8000	1 929,30

(*) İşaretili olan ürünler stoklarla sınırlıdır.

8001-8002

Çatal ve Yıldız Anahtar Sehpası Display Frame For Wrenches



Sacdan imal edilmiş, Fırın boya
Made from metal sheet, Electrostatic paint

KOD CODE	ÖLÇÜ SIZE mm	g	İÇERİK CONTENTS	TL/Ad.
8001 31 6012	160x500	800	Çatal / Open Jaw	1 120,60
8002 31 6012	170x560	1000	Yıldız / Ring	1 150,35

8004

Dövme Çelik Mengene Sehpası Forged Steel Vice Frame



KOD CODE	İÇERİK CONTENTS	g	TL/Ad.
8004 31 6004	Boş - Empty	8000	1 1152,00

8015

Tekerlekli Üçgen Teşhir Standı Triangular Display Frame



Sacdan imal edilmiş, Fırın boya
Made from metal sheet, Electrostatic paint

KOD CODE	ÖLÇÜ SIZE mm	g	TL/Ad.
8015 31 6001	520x1670	29500	1 1633,60



(*) İşaretili olan ürünler stoklarla sınırlıdır.



İzeltaş El Aletleri Teşhir Panosu, satış noktaları için özel olarak dizayn edilmiştir. Kolayca monte edilebilen 19 ana parçadan oluşan panonun derinliği 46 cm, genişliği 100 cm, yüksekliği 220 cm'dir. Etkili görünümü ve tüm ürünleri bir arada sergileme özelliği yanında, perakende satışlarda seçme kolaylığı sağlaması bakımından da önem taşımaktadır.

İzeltaş's Product Exhibition Board has been specially designed for selling points. These boards have been formed from easily mountable 19 main parts and have the dimensions as following, width 46 cm, length 100 cm and height 220 cm.

Board features an impressive looking and displays the products all together, which makes it easy to choose desired tools during retail selling activities.

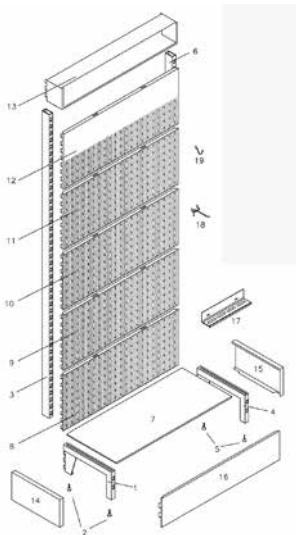

Montaj Sırası / Montage Order

1. Ayak / Stand right leg
2. Plastik ayak / Plastic leg
3. Kolon / Stand right column
4. Ayak / Stand left leg
5. Plastik ayak / Plastic leg
6. Kolon / Stand left column
7. Raf / Shelf
8. Delikli pano / Drilled panel
9. Delikli pano / Drilled panel
10. Delikli pano / Drilled panel
11. Delikli pano / Drilled panel
12. Yarım delikli pano / Half - drilled panel
13. Aydınlatma alınlığı / Illumination panel
14. Yan kapak / Side cover
15. Yan kapak / Side cover
16. Ön kapak / Front cover
17. Tornavida askısı / Screwdriver hanger
18. Büyük askı / Long hanger
19. Küçük askı / Short hanger

Büyük Pano Display Panel (Empty)

KOD CODE	ÖLÇÜ SIZE mm	Cinsi	g	TL/Ad.
8010 31 6001	460x1000x2200	Boş/Empty	43000	1 3135,15

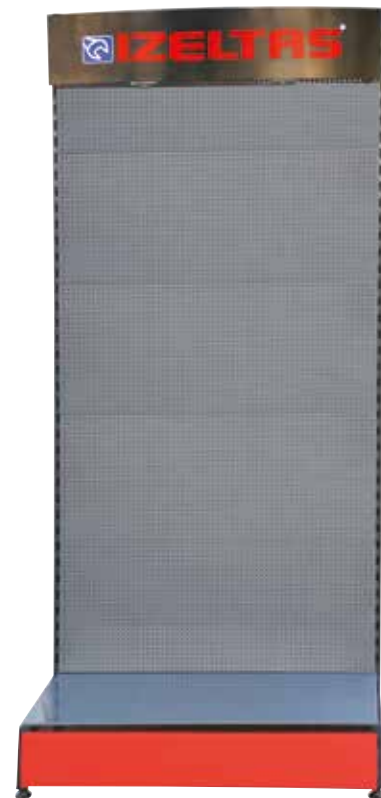

(*) İşaretili olan ürünler stoklarla sınırlıdır.

TEKNİK BİLGİLER

TECHNICAL INFORMATION

Teknik Bilgiler
Technical Informations

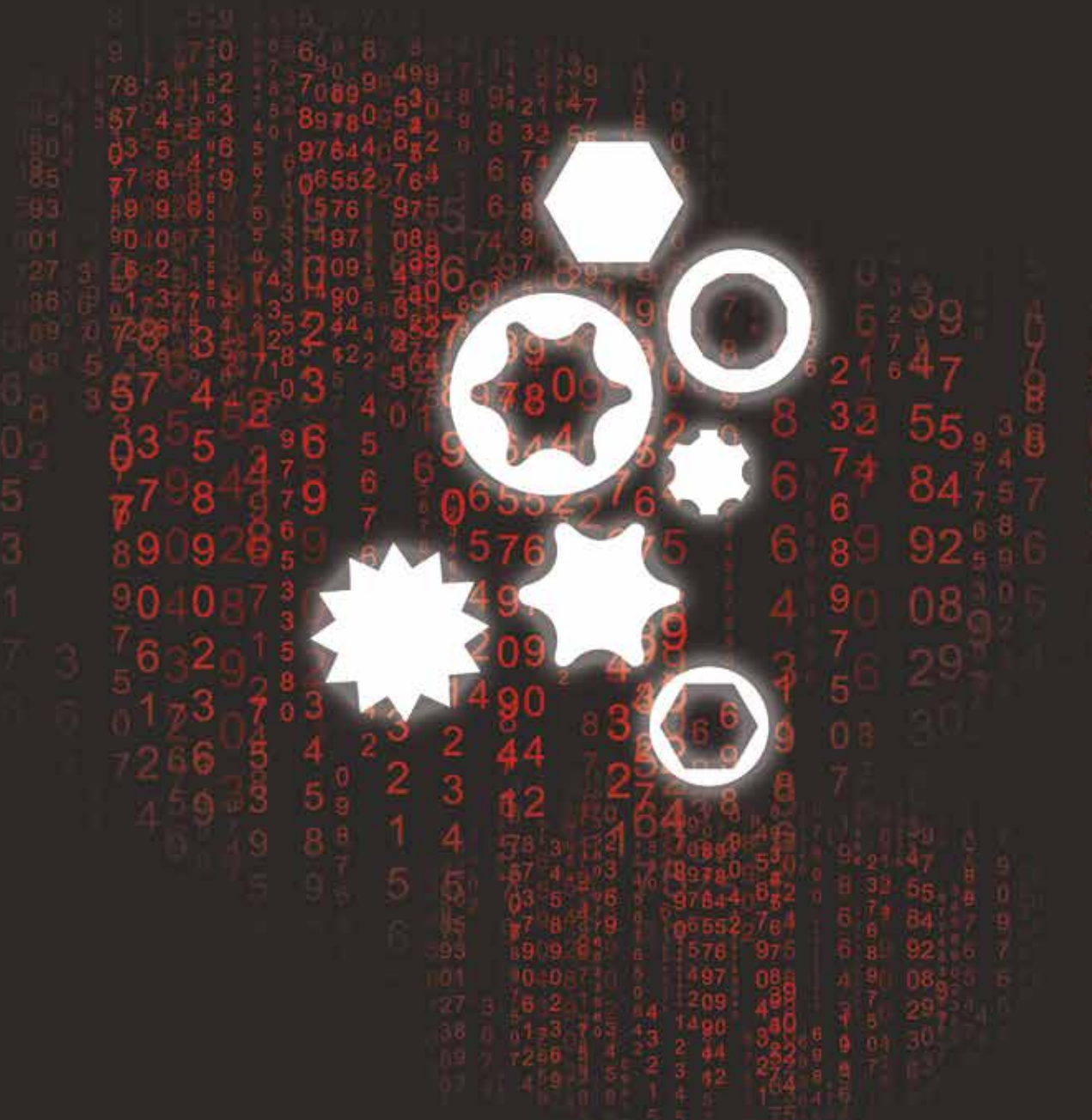



Elektrik akımı geçme (1000V üzeri hariç) ihtimali olan tüm yerlerde IEC 60900'a göre izoleli uygun el aletleri kullanılmalıdır.
Hand tools with IEC 60900 compliant isolation must be used for any work involving risk of electrical current (excluding 1000V and above).



Tozlu ve çapaklı alanlarda mutlaka gözlük kullanınız.
Make sure to wear goggles in work areas with dust and burrs.



Lokma anahtarlarınızı uygun ölçülerdeki cıvata da, en geniş yüzeyde dik olarak kullanınız. Lokma anahtarların cıvataya eğik olarak takılıp kullanılması, kavrama yüzeyini azaltarak ürünün kullanım ömrünü kısaltacaktır.
Use box wrenches with bolts of appropriate size, placed perpendicularly on the largest area of contact. Use of a box wrench at an angle will reduce the gripping surface and result in a shorter useful life.



Yüksek sesli ortamlarda mutlaka kulaklık kullanınız.
Make sure to wear ear protection in work areas with high levels of noise.



Çekici amacı dışında kendinden daha sert malzemelere vurmuyunuz, eğik olarak kullanmayınız. Mantarlaşmış bölgeleri mutlaka temizleyerek kullanınız.
Do not use a hammer outside its intended purpose or to hit objects harder than the hammer. Do not hit at an angle. Make sure to clean weakened parts before use.



Kimyasal madde içeren işlerde mutlaka eldiven ve maske kullanınız. Make sure to wear gloves and facemask for works involving chemical materials.

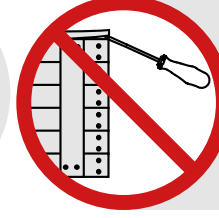

Tornavidayı amacı dışında sökme işlemlerinde kullanmayınız.
Do not use the screwdriver as a levering tool out of its intended purpose.



Anahtarlarınızı, ağız ölçüsüne uygun cıvatalarda kullanınız. Anahtar ve cıvata arasındaki ölçü uyumsuzluğu, üründe ağız aşınmasına neden olur.
Use wrenches with bolts of appropriate size. Size discrepancy between wrench and bolt will lead to wear on tool edge.



Tornavidayı amacı dışında keski gibi ya da darbeli olarak kullanmayınız.
Do not use the screwdriver as a chiselling tool or for impacting out of its intended purpose.



Anahtarların ağızına taşlama işlemi yapmayınız; sert cisimler sürterek müdahale etmeyiniz. Bu durum anahtarınızın ağız yapısını bozar.
Do not grind or expose the edge of wrenches to hard objects. This will deform the tool edge structure.



Dolapları çekerek değil iterek kullanınız.
Do not pull the set cabinets. Push to move the cabinets.



Anahtar gövdesine boru takarak kuvvet uygulamayınız. Anahtarınızın ağız yapısının bozulmasına, kırılmalara ve yaralanmalara neden olabilir.
Do not apply force to the wrench by attaching a pipe to the tool body. This may result in deformation of tool edge, breakage or injury.



Dolapların birden fazla çekmesini aynı anda açık bırakmayınız. Ağırlık merkezi değişerek dolabın devrilmesine neden olacaktır.
Do not leave multiple drawers of set cabinets open at the same time. This will move the centre of gravity and cause toppling.



Anahtar gövdesine çekiç ile darbe uygulamayınız. Ağız yapısında bozulmalara, kırılma ve yaralanmalara neden olabilir.
Do not hit the wrench body with a hammer. This may result in deformation of tool edge, breakage or injury.



Dolapların çekmecelerini ayağınızla kapatmaya ya da basarak, merdiven olarak kullanmaya çalışmayınız. Bu gibi durumlar yaralanmalara sebep olacaktır.
Do not use your foot to close a cabinet drawer or attempt to use cabinet drawers as a stepladder. Such actions will result in injury.

TEKNİK BİLGİLER/TECHNICAL DATA

ANAHTAR AĞZI ÖLÇÜLERİ VE VİDA ÇAPLARI SPANNER JAW WIDTH ACCROSS FLATS and THREAD DIAMETERS

mm		AF		Ağız Genişliği	Civata Çapı	Ağız Genişliği	mm		
DIN ISO 272 ye göre metrik		DIN ISO 272 ye göre metrik		inch	mm	Whitw.	BS 916 1083	inch	mm
4	2		5/32	0,1562	3,97	8 BA		0,152	3,86
4,5	2,3					7 BA		0,172	4,87
5	2,5		3/16	0,1875	4,76	6 BA		0,193	4,90
5,5	3,5		7/32	0,2187	5,56	5 BA		0,220	5,59
6	26,8		1/4	0,2500	6,35	4 BA		0,248	6,30
						1/16 W		0,256	6,50
7	4		9/32	0,2812	7,14	3 BA		0,282	7,16
						3/32 W		0,297	7,54
7-8	5		5/16	0,3125	7,94	2 BA		0,324	8,23
9	5 Alt		11/32	0,3438	8,73	1/8 W	(3/16)	0,340	8,64
			3/8	0,3750	9,52	1 BA		0,365	9,27
8-10	6		13/32	0,4062	10,32	0 BA	(7/32)	0,413	10,49
11	7		7/16	0,4375	11,11	3/16 W	1/4	0,445	11,30
12									
10-13	8		1/2	0,5000	12,70	1/4 W	5/16	0,525	13,34
14*	8 Alt		9/16	0,5625	14,29				
15	10 KFZ		19/32	0,5938	15,08	5/16 W	3/8	0,600	15,24
16	10		5/8	0,6250	15,88				
13-15-17	10		11/16	0,6875	17,46				
18	12					3/8 W	7/16	0,710	18,03
15-18-19	12		3/4	0,7500	19,05				
20*			25/32	0,7812	19,84				
18-21	14		13/16	0,8125	20,64	7/16 W	1/2	0,820	20,83
22-24	14		7/8	0,8750	22,22				
23*						1/2 W	9/16	0,920	23,37
21-24*	16		15/16	0,9375	23,81				
25*-27*			1,	1,0000	25,40				
26*						9/16 W	5/8	1,010	25,65
27	18	16	1.1/16	1,0625	26,99				
27-28*-30						5/8 W	(11/16)	1,100	27,94
			1.1/8	1,1250	28,58				
27-30-34	20		1.3/16	1,1875	30,16	11/16 W	3/4	1,200	30,48
32-36-41	22	20	1.1/4	1,2500	31,75				
			1.5/16	1,3125	33,34	3/4 W	7/8	1,300	33,02
34	22		1.3/8	1,3750	34,92	13/16 W	(15/16)	1,390	35,31
36-41	24	22	1.7/16	1,4375	36,51				
38*			1.1/2	1,5000	38,10	7/8 W	1	1,480	37,59
41-46	27	24	1.5/8	1,6250	41,28				
			1.11/16	1,6875	42,86	1. W	1.1/8	1,670	42,42
			1.3/4	1,7500	44,45				
46-50	30	27	1.13/16	1,8125	46,04				
			1.7/8	1,8750	47,62	1.1/8 W	1.1/4	1,860	47,24
50-55	33	30	2,	2,0000	50,80				
			2.1/16	2,0625	52,39	1.1/4 W	1.3/8	2,050	52,07
55-60	36		2.3/16	2,1875	55,56				
			2.1/4	2,2500	57,15	1.3/8 W	1.1/2	2,220	56,39
60-65	39	36	2.3/8	2,3750	60,32				
			2.7/16	2,4375	61,91	1.1/2 W	1.5/8	2,410	61,21
65	42		2.9/16	2,5625	65,09	1.5/8	1.3/4	2,580	65,53
			2.5/8	2,6250	66,68				
70	45		2.3/4	2,7500	69,85	1.3/4 W	2,	2,760	70,10
			2.13/16	2,8125	71,44				
75	48		2.15/16	2,9375	74,61				
			3,	3,0000	76,20	(1.7/8 W)			76,70
80	52		3.1/8	3,1250	79,38	2. W	2.1/4	3,150	80,01
85	56		3.3/8	3,3750	85,72				
90	60		3.1/2	3,5000	88,90		2.1/2	3,550	90,17
95	64		3.3/4	3,7500	92,25				
			3.7/8	3,8750	98,42		2.3/4	3,890	98,81
100	68								
105	72		4.1/8	4,1250	104,78		3,	4,180	106,17
110	76		4.1/4	4,2500	107,95				
115*	80		4.1/2	4,5000	114,30		3.1/4	4,530	115,06

ANAHTAR İÇİN MİNİMUM DÖNDÜRME MOMENTLERİ TEST TORQUE VALUES FOR SPANNERS ISO 1711-1

mm	0430	0440	0100	1800	1870
0320			0130		1874
0330					
0370					
4			1,90		
4,5*			2,64		
5			3,55		
5,5			4,64		
6*	17,6	7,4	5,92	17,6	
7	25,2	11,4	9,12	25,2	
8	34,5	16,6	13,3	34,5	34,5
9*	45,5	23,0	18,4	45,5	45,5
10	58,1	31,0	24,8	58,1	58,1
11	72,7	40,4	32,3	72,7	72,7
12	89,1	51,5	41,2	89,1	89,1
13	107	64,5	51,6	107	107
14*	128	79,4	63,5	128	128
15	150	96,2	77,0	150	150
16	175	115	92,3	175	175
17	201	134	107	201	201
18	230	160	128	230	230
19*	261	186	149	261	261
20*	294	215	172	294	294
21	330	247	198	330	330
22*	368	281	225	368	368
23*	408	319	255	408	408
24	451	359	287	451	451
25*	496	402	322	496	496
26*	544	449	359	544	544
27	594	499	399	594	594
28*	647	552	442	647	647
30	760	670	536	760	760
32*	884	804	643	884	884
34	1019	951	761	1019	1019
36	1165	1117	994	1165	1165
41	1579	1442	1154	1579	1579
46	2067	1816	1453	2067	2067
50	2512	2145	1716	2512	2512
55	3140		2077	3140	3140
60	3849		2471	3849	
65	4021				
70	4658				
75	5394				

* Standart dışı/Not Standardised

VIDA AĞIZ ÖLÇÜLERİ
GUIDELINE FOR SCREWDRIVERS

	M 1.6 (M 1.7)	M 2	M 2.3	(M 2.3) (M 2.6)	M 3	(M 3.5)	M 4	M 5	M 6	M 8	M 10
"Metrik Vida Metric screw"											
Düz başlı Vidalar Flat head screws	0.4 x 3 (3.2)	0.5 x 3.8	0.6 x 4.4	0.6 x 4.5 (5)	0.8 x 5.5	0.8 x 6	1 x 7	1.2 x 8.5	1.6 x 10	2 x 13	2.5 x 16
Düz başlı Vidalar Flat head screws	—	—	—	—	0.8 x 6	0.8 x 7	1 x 8	1.2 x 10	1.6 x 12	2 x 16	2.5 x 20
Düz başlı Vidalar (küçük) Flat head screws (small sizes)	—	—	—	0.4 x 3.5	0.5 x 4	0.5 x 4.5	0.6 x 5.5	0.8 x 6.5	1 x 8	1.2 x 10	1.6 x 13
Oval başlı Vidalar Oval head screws	0.4 x 3	0.5 x 3.8	—	0.6 x 4.7	0.8 x 5.6	—	—	—	—	—	—
Havşa başlı Vidalar Countersank head screws	0.4 x 3	0.5 x 3.8	—	0.6 x 4.7	0.8 x 5.6	0.8 x 6.5	1 x 7.5	1.2 x 9.2	1.6 x 11	2 x 14.5	2.5 x 18

YILDIZ VIDALAR İÇİN UYGUN TORNAVİDA AĞIZ ÖLÇÜLERİ
SUITABLE TIPS FOR CROSS HEAD SCREWS

Yıldız Ağız Ölçüsü Cross Slot Size	Metrik Vidalar Metric Screw
0	M 1.6 - M 2
1	M 2 - M 2.5 - M 3
2	M 3.5 - M 5
3	M 6
4	M 8 - M 10



TEKNİK BİLGİLER/TECHNICAL DATA

METRİK VIDALAR İÇİN LOKMA SEÇİMİ GUIDE TO METRIC SIZES COVERED BY SOCKET WRENCHES FOR EACH DRIVE

	1107 6,3	1110 10	1113 12,5	1119 20	1125 25
	1/4"	3/8"	1/2"	3/4"	1"
M 2	4				
	4,5				
M 2.5	5				
M 3	5,5				
M 3.5	6	6			
M 4	7	7			
M 5	8	8	8		
	9	9	9		
M 6	10	10	10	10	
M 7	11	11	11	11	
	12	12	12	12	
M 8	13	13	13	13	
		14	14	14	
		15	15	15	
M 10		16	16	16	
M 10		17	17	17	17
M 12		18	18	18	18
M 12		19	19	19	19
		20	20		
M 14		21	21	21	21
M 14		22	22	22	22
		23	23	23	23
M 16			24	24	24
			25		
			26		
M 18			27	27	27
			28		
M 20			30	30	30
M 22			32	32	32
			33	33	33
M 22			34	34	34
M 24				36	36
				38	38
M 27				41	41
				42	
M 30				46	46
M 33				50	50
M 36				55	55
M 39				60	60
M 42				65	65
M 45				70	70
M 48				75	75
M 52					

LOKMA İÇİN MİN DÖNDÜRME MOMENTLERİ TEST TORQUE VALUES FOR SOCKET ISO 1711-1 (N-m)

		6,3 1107	10 1110	12,5 1113 1114	20 1119 1120	25 1125
	mm	1/4	3/8	1/2	3/4	1
M2	4	10,4				
M 2.2	4.5*	12,6				
M 2.5	5	15,1				
M 3	5,5	17,8				
M 3.5	6*	20,6	23,2			
M 4	7	26,8	33,2			
M 5	8	33,6	45,5	94,1		
	9*	41,1	59,9	119,2		
M 6	10	49,1	76,7	147		
M 7	11	57,8	96	178		
	12	67,0	118	212		
M 8	13	68,6	141	249		
	14*	68,6	169	288		
	15		198	331		
	16		225	377		
M 10	17		225	425		
	18		225	477		
M 12	19*		225	531		
	20*		225	569		
	21		225	569	-	
M 14	22*		225	569	569	
	23*			569	569	
M 16	24			569	569	
	25*			569	583	
	26*			569	624	
M 18	27			569	665	
	28*			569	707	
M 20	30			569	795	
M 22	32*			569	888	
	34			569	984	
M 24	36				1084	1677
M 27	41				1353	1910
M 30	46				1569	2143
M 33	50				1569	2329
M 36	55				1569	2562
M 39	60				1569	2795
M 42	65					2795
M 45	70					2795
M 48	75					2795
M 52	80					2795

(*) İşaretili olan ürünler stoklarla sınırlıdır.

SIKMA / TEST TORK DEĞERLERİ TIGHTENING / TEST TORQUE VALUES

Önerilen (Bağlayıcı olmayan) cıvata sıkma torkları Nm (Newton Metre)
Suggested (Not Compulsory) Bolt Tightening Torque in Nm (Newton Meter)

Kalite Sınıfı DIN 267'ye Göre Sıkma Değerleri
Tightening Torques Values According to Quality Class DIN 267

	4.6	5.6	6.9	8.8	10.9	12.9
M 2	0,123	0,162	0,314	0,373	0,520	0,628
M 2,2	0,196	0,265	0,510	0,598	0,843	1,010
M 2,5	0,284	0,373	0,726	0,863	1,206	1,451
M 3	0,441	0,588	1,128	1,344	1,883	2,256
M 3,5	0,677	0,902	1,736	2,060	2,893	3,481
M 4	1,000	1,344	2,599	3,040	4,315	5,148
M 5	1,916	2,648	5,099	6,031	8,483	10,200
M 6	3,432	4,511	8,728	10,300	14,710	17,652
M 7	5,590	7,453	14,220	17,162	24,517	28,439
M 8	8,238	10,787	21,575	25,497	35,304	42,168
M 10	16,67	21,575	42,168	50,014	70,608	85,317
M 12	28,44	38,246	73,550	87,279	122,60	147,10
M 14	45,11	60,801	116,70	138,30	194,20	235,40
M 16	69,63	93,163	178,5	210,80	299,10	357,90
M 18	95,12	127,50	245,20	289,3	411,90	490,30
M 20	135,3	180,45	384,10	411,90	578,60	696,30
M 22	182,4	245,16	470,70	559,00	784,50	941,40
M 24	230,5	308,91	598,20	711,00	1000	1196
M 27	343,2	460,90	887,50	1049	1481	1775
M 30	465,8	622,72	1206	1422	2010	2403
M 33	632,5	848,30	1628	1932	2716	3266
M 36	814,0	1089	2099	2481	3491	4197
M 39	1059	1412	2716	3226	4531	5443
M 42	1304	1746	3364	3991	5609	6727
M 45	1638	2177	4207	4992	7012	8414
M 48	1981	2638	5080	6021	8473	10150
M 52	2540	3393	6541	7747	10885	13092
M 56	3168	4227	8149	9650	13582	16279
M 60	3932	5247	10101	11964	16867	20202
M 64	4737	6306	12160	14416	20300	24320

Moment Değerleri Yağlanmış Cıvatalar İçin %20 Azaltılmalıdır.
Torque Values Should be Decreased of 20% for Lubricated Screws

(★) İşaretili olan ürünler stoklarla sınırlıdır.

Ölçü Birimleri Measuring Units

Giga	G	1.000.000.000	=10 ⁹	1GW= 1 Milyar Watt
Mega	M	1.000.000	=10 ⁶	1 MW= 1 Milyon Watt
Kilo	k	1.000	=10 ³	1 kW= Bin Watt
Milli	m	0.001	=10 ⁻³	1 mm= Binde Bir Watt
Mikro	μ	0.000001	=10 ⁻⁶	1 μm= 1 Milyonda Bir Watt
Nano	n	0.000000001	=10 ⁻⁹	1 nm= 1 Milyarda Bir Watt

Önemli Ölçülerin Değişim Tablosu Conversion Table For Essential Measuring Units

Uzunluk Length	Metre	m		
Kütle Weight	Kilogram	kg		
Zaman Time	Saniye	s		
Kuvvet Force	Newton	N	=kg m/s ²	1 N= 0.102 kp
Döndürme Mom. Torque	Newtonmetre			9.81 Nm= 1kpm
Iş Enerjisi Work	Joule	J	=Nm	
Isı Enerjisi Heat	Joule	J		1 J= 0.239 cal
Güç Power	Watt	W	=Nm/s	1 kW= 1.36 PS=860 kcal/h
Basınç Pressure	Pascal	Pa	=N/m ²	100.000 Pa=1 bar=10 mWS
Elektrik Akımı Electricity Current	Amper	A		
Sıcaklık Temperature	Kelvin	K		1K= -272.15 °C

Döndürme Momenti Dönüşüm Tablosu Conversion Table For Bending Moments

Var Olan Ölçüler / present units	İstenen Ölçüler / Wanted Units					
	=Ncm	=Nm	=kpcm	=kpm	=lbf.in.	=lbf.ft.
Ncm	1	0.01	0.10197	0.00102	0.0885	0.00738
Nm	100	1	10.197	0.10197	8.851	0.7376
kpcm	9.807	0.09807	1	0.01	0.868	0.0723
kpm	980.07	9.807	100	1	86.796	7.233
lbf.in.	11.298	0.11298	1.152	0.01152	1	0.0833
lbf.ft.	135.58	1.3558	13.825	0.13825	12	1

Newton-Metre ve Librefoot Dönüşüm Tablosu Conversion Table Of Newton-Meter And Librefoot (1 Nm=0.738 lbf.ft.)

Nm	ft.,lbs.									
	0	1	2	3	4	5	6	7	8	9
0	0	0.74	1.48	2.21	2.95	3.69	4.43	5.17	5.90	6.64
10	7.38	8.12	8.86	9.59	10.33	11.07	11.81	12.54	13.28	14.02
20	14.76	15.50	16.2	16.97	17.71	18.45	19.19	19.93	20.65	21.40
30	22.14	22.88	23.62	24.35	25.10	25.83	26.57	27.31	28.04	28.78
40	29.52	30.26	31.00	31.73	32.47	33.21	33.95	34.69	35.42	36.16
50	36.90	37.64	38.38	39.11	39.85	40.59	41.33	42.07	42.80	43.54
60	44.28	45.02	45.76	46.49	47.23	47.97	48.71	49.45	50.18	50.92
70	51.66	52.40	53.14	53.87	54.61	55.35	56.09	56.83	57.56	58.30
80	59.04	59.78	60.52	61.25	62.00	62.73	63.47	64.21	64.94	65.68
90	66.42	67.16	67.90	68.63	69.37	70.11	70.85	71.59	72.32	73.06
100	73.80	74.54	75.28	76.01	76.75	77.49	78.23	78.97	79.70	80.44

Librefoot ve Newton-Metre Dönüşüm Tablosu Conversion Table Of Librefoot And Newton-Meter (1 lbf.ft.=1.356 Nm)

ft., lbs.	Nm									
	0	1	2	3	4	5	6	7	8	9
0	0	1.36	2.71	4.07	5.42	6.78	8.14	9.49	10.85	12.20
10	13.56	14.92	16.27	17.63	18.98	20.34	21.70	23.05	24.41	25.76
20	27.12	28.48	29.83	31.19	32.54	33.90	35.26	36.61	37.97	39.32
30	40.68	42.04	43.39	44.75	46.10	47.46	48.82	50.17	51.53	52.88
40	54.24	55.60	56.95	58.31	59.66	61.02	62.38	63.73	65.09	66.44
50	67.80	69.16	70.51	71.87	73.22	74.58	75.94	77.29	78.65	80.00
60	81.36	82.72	84.07	85.43	86.78	88.14	89.50	90.85	92.21	93.56
70	94.92	96.28	97.63	98.99	100.34	101.70	103.06	104.41	105.77	107.12
80	108.48	109.84	111.19	112.55	113.90	115.26	116.62	117.97	119.33	120.68
90	122.04	123.40	124.75	126.11	127.46	128.82	130.18	131.53	132.89	134.24
100	135.60	136.96	138.31	139.67	141.02	142.38	143.74	145.09	146.45	147.80

Newton-Metre ve Kilopound-Metre Dönüşüm Tablosu Conversion Table Of Newton-Meter and Kilopound-Meter (1 Nm=0.102 kpm)

Nm	kpm									
	0	1	2	3	4	5	6	7	8	9
0	0.00	1.02	2.04	3.06	4.08	5.10	6.12	7.14	8.16	9.18
100	10.20	11.22	12.24	13.26	14.28	15.30	16.31	17.33	18.35	19.37
200	20.39	21.41	22.43	23.45	24.47	25.49	26.51	27.53	28.55	29.57
300	30.59	31.61	32.63	33.65	34.67	35.69	36.71	37.73	38.75	39.77
400	40.79	41.81	42.83	43.85	44.87	45.89	46.91	47.93	48.95	49.97
500	50.99	52.01	53.02	54.04	55.06	56.08	57.10	58.12	59.14	60.16
600	61.18	62.20	63.22	64.24	65.26	66.28	67.30	68.32	69.34	70.36
700	71.38	72.40	73.42	74.44	75.46	76.48	77.50	78.52	79.54	80.56
800	81.58	82.60	83.62	84.64	85.66	86.68	87.70	88.71	89.73	90.75
900	91.77	92.79	93.81	94.83	95.85	96.87	97.89	98.91	99.93	100.95
1000	101.97	102.99	104.01	105.03	106.05	107.07	108.09	109.11	110.13	111.15



Sertlik Dönüşüm Tablosu

Hardness Conversion Table

Vickers Sertlik Hardness	Brinell Sertlik Hardness	Rockwell Sertlik Hardness		Çekme dayanımı Tensile Strength
HV 30	HB 30	HRB	HRC	sB N/mm2
80	80.7	36.4	-	270
85	85	42.4	-	290
90	90	47.4	-	310
95	95	52.00	-	320
100	100	56.4	-	340
105	105	60.0	-	360
110	110	63.4	-	380
115	115	66.4	-	390
120	120	69.4	-	410
125	125	72.0	-	420
130	130	74.4	-	440
135	135	76.4	-	460
140	140	78.4	-	470
145	145	80.4	-	490
150	150	82.2	-	500
155	155	83.8	-	520
160	160	85.4	-	540
165	165	86.8	-	550
170	170	88.2	-	570
175	175	89.6	-	590
180	180	90.8	-	600
185	185	91.8	-	620
195	190	91.5	-	640
200	195	94.0	-	660
200	200	95.0	-	670
205	205	95.8	-	680
210	210	96.6	-	710
215	215	97.4	-	720
220	220	98.2	-	730
225	225	99.0	-	750
230	230	-	19.2	760
235	235	-	20.2	780
240	240	-	21.2	800
245	245	-	22.1	820
250	250	-	23.0	830
255	255	-	23.8	850
260	260	-	24.6	870
265	265	-	25.4	880
280	280	-	27.1	900
275	275	-	26.9	920
280	280	-	27.6	940
285	285	-	28.3	950
290	290	-	29.0	970
295	295	-	29.6	990
300	300	-	30.3	1010
310	310	-	31.5	1040
320	320	-	32.7	1080
330	330	-	33.8	1110

Vickers Sertlik Hardness	Brinell Sertlik Hardness	Rockwell Sertlik Hardness		Çekme dayanımı Tensile Strength
HV 30	HB 30	HRB	HRC	sB N/mm2
340	340	-	34.9	1140
350	350	-	36.0	1170
360	359	-	37.0	1200
370	368	-	38.0	1260
380	376	-	38.9	1260
390	385	-	39.8	1290
400	392	-	40.7	1320
410	400	-	41.5	1350
420	408	-	42.4	1380
440	423	-	44.0	1430
450	430	-	44.8	1460
460	-	-	45.6	-
470	-	-	46.3	-
480	-	-	47.0	-
490	-	-	47.7	-
500	-	-	48.3	-
510	-	-	49.1	-
520	-	-	49.7	-
530	-	-	50.4	-
540	-	-	51.0	-
550	-	-	51.6	-
560	-	-	52.2	-
570	-	-	52.8	-
580	-	-	53.3	-
590	-	-	53.9	-
600	-	-	54.4	-
610	-	-	55.0	-
620	-	-	55.5	-
630	-	-	56.0	-
640	-	-	56.5	-
650	-	-	57.0	-
660	-	-	57.5	-
670	-	-	58.0	-
680	-	-	58.5	-
690	-	-	59.0	-
700	-	-	59.5	-
720	-	-	60.4	-
740	-	-	61.2	-
760	-	-	62.0	-
780	-	-	62.8	-
800	-	-	63.6	-
820	-	-	64.3	-
840	-	-	65.0	-
860	-	-	65.7	-
880	-	-	66.3	-
900	-	-	66.9	-
920	-	-	67.5	-
940	-	-	68.0	-

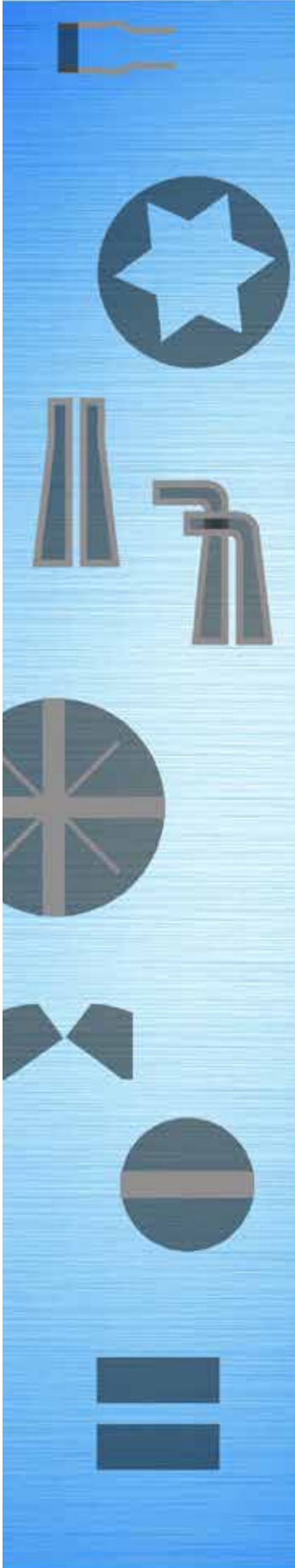

Semboller / Symbols

Anahtar Ağız
Size



Ağız Açıklığı
Opening Limit of Jaws



Altı Köşe Lokma Bijon
Anahtar Ağız
Six Point Sockets



Sekiz Köşe Anahtar Ağız
Eight Point Wrench



On iki Köşe Anahtar Ağız
Twelve Point Wrench



Kare Adaptör
Square Adapter



Kovan Anahtar
Tubular Socket Wrench



Bir Ağız Bijon Anahtar
Single Ended Rim Wrench



TORX® Lokma Anahtar
TORX Socket



Düz Uç
Flat Tip



Yıldız Uç
PHILLIPS® Tip



POZIDRIV® Yıldız Uç
POZIDRIV® Tip



TORX® Uç
TORX® Tip



Delikli TORX® Uç
TORX® with hole



Bits Tutucular
Bit Holders



Allen Anahtar
Hexagonal Allen Keys



Segman
Circlip



Gövde Ağırlık
Weight of Body



Tapa Anahtar
Wrench for Carter Case



İşkençe
Screw Clamp



Çektirme
Puller

in.	dec.in.	0"	1"	2"	3"	4"	5"	6"	7"	8"	9"	10"	11"
		millimeters (mm)											
0	0	0	25.400 0	50.800 0	76.200 0	101.600 0	127.000 0	152.400 0	177.800 0	203.200 0	228.600 0	254.000 0	279.400 0
1/64	0.015 625	0.396 9	25.796 9	51.196 9	76.596 9	101.996 9	127.396 9	152.796 9	178.196 9	203.596 9	228.996 9	254.396 9	279.796 9
1/32	0.031 25	0.793 8	26.193 8	51.593 8	76.993 8	102.393 8	127.793 8	153.193 8	178.593 8	203.993 8	229.393 8	254.793 8	280.193 8
3/64	0.046 875	1.190 6	26.590 6	51.990 6	77.390 6	102.790 6	128.190 6	153.590 6	178.990 6	204.390 6	229.790 6	255.190 6	280.590 6
1/16	0.062 5	1.587 5	26.987 5	52.387 5	77.787 5	103.187 5	128.587 5	153.987 5	179.387 5	204.787 5	230.187 5	255.587 5	280.987 5
5/64	0.078 125	1.984 4	27.384 4	52.784 4	78.184 4	103.584 4	128.984 4	154.384 4	179.784 4	205.184 4	230.584 4	255.984 4	281.384 4
3/32	0.093 75	2.381 2	27.781 2	53.181 2	78.581 2	103.981 2	129.381 2	154.781 2	180.181 2	205.581 2	230.981 2	256.381 2	281.781 2
7/64	0.109 375	2.778 1	28.178 1	53.578 1	78.978 1	104.378 1	129.778 1	155.178 1	180.578 1	205.978 1	231.378 1	256.778 1	282.178 1
1/8	0.125	3.175 0	28.575 0	53.975 0	79.375 0	104.775 0	130.175 0	155.575 0	180.975 0	206.375 0	231.775 0	257.175 0	282.575 0
9/64	0.140 625	3.571 9	28.971 9	54.371 9	79.771 9	105.171 9	130.571 9	155.971 9	181.371 9	206.771 9	232.171 9	257.571 9	282.971 9
5/32	0.156 25	3.968 8	29.368 8	54.768 8	80.168 8	105.568 8	130.968 8	156.368 8	181.768 8	207.168 8	232.568 8	257.968 8	283.368 8
11/64	0.171 875	4.365 6	29.765 6	55.165 6	80.565 6	105.965 6	131.365 6	156.765 6	182.165 6	207.565 6	232.965 6	258.365 6	283.765 6
3/16	0.187 5	4.762 5	30.162 5	55.562 5	80.962 5	106.362 5	131.762 5	157.162 5	182.562 5	207.962 5	233.362 5	258.762 5	284.162 5
13/64	0.203 125	5.159 4	30.559 4	55.959 4	81.359 4	106.759 4	132.159 4	157.559 4	182.959 4	208.359 4	233.759 4	259.159 4	284.559 4
7/32	0.218 75	5.556 2	30.956 2	56.356 2	81.756 2	107.156 2	132.556 2	157.956 2	183.356 2	208.756 2	234.156 2	259.556 2	284.956 2
15/64	0.234 375	5.953 1	31.353 1	56.753 1	82.153 1	107.553 1	132.953 1	158.353 1	183.753 1	209.153 1	234.553 1	259.953 1	285.353 1
1/4	0.25	6.350 0	31.750 0	57.150 0	82.550 0	107.950 0	133.350 0	158.750 0	184.150 0	209.550 0	234.950 0	260.350 0	285.750 0
17/64	0.265 625	6.746 9	32.146 9	57.546 9	82.946 9	108.346 9	133.746 9	159.146 9	184.546 9	209.946 9	235.346 9	260.746 9	286.146 9
9/32	0.281 25	7.143 8	32.543 8	57.943 8	83.343 8	108.743 8	134.143 8	159.543 8	184.943 8	210.343 8	235.743 8	261.143 8	286.543 8
19/64	0.296 875	7.540 6	32.940 6	58.340 6	83.740 6	109.140 6	134.540 6	159.940 6	185.340 6	210.740 6	236.140 6	261.540 6	286.940 6
5/16	0.312 5	7.937 5	33.337 5	58.737 5	84.137 5	109.537 5	134.937 5	160.337 5	185.737 5	211.137 5	236.537 5	261.937 5	287.337 5
21/64	0.328 125	8.334 4	33.734 4	59.134 4	84.534 4	109.934 4	135.334 4	160.734 4	186.134 4	211.534 4	236.934 4	262.334 4	287.734 4
11/32	0.343 75	8.731 2	34.131 2	59.531 2	84.931 2	110.331 2	135.731 2	161.131 2	186.531 2	211.931 2	237.331 2	262.731 2	288.131 2
23/64	0.359 375	9.128 1	34.528 1	59.928 1	85.328 1	110.728 1	136.128 1	161.528 1	186.928 1	212.328 1	237.728 1	263.128 1	288.528 1
3/8	0.375	9.525 0	34.925 0	60.325 0	85.725 0	111.125 0	136.525 0	161.925 0	187.325 0	212.725 0	238.125 0	263.525 0	288.925 0
25/64	0.390 625	9.921 9	35.321 9	60.721 9	86.121 9	111.521 9	136.921 9	162.321 9	187.721 9	213.121 9	238.521 9	263.921 9	289.321 9
13/32	0.406 25	10.318 8	35.718 8	61.118 8	86.518 8	111.918 8	137.318 8	162.718 8	188.118 8	213.518 8	238.918 8	264.318 8	289.718 8
27/64	0.421 875	10.715 6	36.115 6	61.515 6	86.915 6	112.315 6	137.715 6	163.115 6	188.515 6	213.915 6	239.315 6	264.715 6	290.115 6
7/16	0.437 5	11.112 5	36.512 5	61.912 5	87.312 5	112.712 5	138.112 5	163.512 5	188.912 5	214.312 5	239.712 5	265.112 5	290.512 5
29/64	0.453 125	11.509 4	36.909 4	62.309 4	87.709 4	113.109 4	138.509 4	163.909 4	189.309 4	214.709 4	240.109 4	265.509 4	290.909 4
15/32	0.468 75	11.906 2	37.306 2	62.706 2	88.106 2	113.506 2	138.906 2	164.306 2	189.706 2	215.106 2	240.506 2	265.906 2	291.306 2
31/64	0.484 375	12.303 1	37.703 1	63.103 1	88.503 1	113.903 1	139.303 1	164.703 1	190.103 1	215.503 1	240.903 1	266.303 1	291.703 1
1/2	0.5	12.700 0	38.100 0	63.500 0	88.900 0	114.300 0	139.700 0	165.100 0	190.500 0	215.900 0	241.300 0	266.700 0	292.100 0
33/64	0.515 625	13.096 9	38.496 9	63.896 9	89.296 9	114.696 9	140.096 9	165.496 9	190.896 9	216.296 9	241.696 9	267.096 9	292.496 9
17/32	0.531 25	13.493 8	38.893 8	64.293 8	89.693 8	115.093 8	140.493 8	165.893 8	191.293 8	216.693 8	242.093 8	267.493 8	292.893 8
35/64	0.546 875	13.890 6	39.290 6	64.690 6	90.090 6	115.490 6	140.890 6	166.290 6	191.690 6	217.090 6	242.490 6	267.890 6	293.290 6
9/16	0.562 5	14.287 5	39.687 5	65.087 5	90.487 5	115.887 5	141.287 5	166.687 5	192.087 5	217.487 5	242.887 5	268.287 5	293.687 5
37/64	0.578 125	14.684 4	40.084 4	65.484 4	90.884 4	116.284 4	141.684 4	167.084 4	192.484 4	217.884 4	243.284 4	268.684 4	294.084 4
19/32	0.593 75	15.081 2	40.481 2	65.881 2	91.281 2	116.681 2	142.081 2	167.481 2	192.881 2	218.281 2	243.681 2	269.081 2	294.481 2
39/64	0.609 375	15.478 1	40.878 1	66.278 1	91.678 1	117.078 1	142.478 1	167.878 1	193.278 1	218.678 1	244.078 1	269.478 1	294.878 1
5/8	0.625	15.875 0	41.275 0	66.675 0	92.075 0	117.475 0	142.875 0	168.275 0	193.675 0	219.075 0	244.475 0	269.875 0	295.275 0
41/64	0.640 625	16.271 9	41.671 9	67.071 9	92.471 9	117.871 9	143.271 9	168.671 9	194.071 9	219.471 9	244.871 9	270.271 9	295.671 9
21/32	0.656 25	16.668 8	42.068 8	67.468 8	92.868 8	118.268 8	143.668 8	169.068 8	194.468 8	219.868 8	245.268 8	270.668 8	296.068 8
43/64	0.671 875	17.065 6	42.465 6	67.865 6	93.265 6	118.665 6	144.065 6	169.465 6	194.865 6	220.265 6	245.665 6	271.065 6	296.465 6
11/16	0.687 5	17.462 5	42.862 5	68.262 5	93.662 5	119.062 5	144.462 5	169.862 5	195.262 5	220.662 5	246.062 5	271.462 5	296.862 5
45/64	0.703 125	17.859 4	43.259 4	68.659 4	94.059 4	119.459 4	144.859 4	170.259 4	195.659 4	221.059 4	246.459 4	271.859 4	297.259 4
23/32	0.718 75	18.256 2	43.656 2	69.056 2	94.456 2	119.856 2	145.256 2	170.656 2	196.056 2	221.456 2	246.856 2	272.256 2	297.656 2
47/64	0.734 375	18.653 1	44.053 1	69.453 1	94.853 1	120.253 1	145.653 1	171.053 1	196.453 1	221.853 1	247.253 1	272.653 1	298.053 1
3/4	0.75	19.050 0	44.450 0	69.850 0	95.250 0	120.650 0	146.050 0	171.450 0	196.850 0	222.250 0	247.650 0	273.050 0	298.450 0
49/64	0.765 625	19.446 9	44.846 9	70.246 9	95.646 9	121.046 9	146.446 9	171.846 9	197.246 9	222.646 9	248.046 9	273.446 9	298.846 9
25/32	0.781 25	19.843 8	45.243 8	70.643 8	96.043 8	121.443 8	146.843 8	172.243 8	197.643 8	223.043 8	248.443 8	273.843 8	299.243 8
51/64	0.796 875	20.240 6	45.640 6	71.040 6	96.440 6	121.840 6	147.240 6	172.640 6	198.040 6	223.440 6	248.840 6	274.240 6	299.640 6
13/16	0.812 5	20.637 5	46.037 5	71.437 5	96.837 5	122.237 5	147.637 5	173.037 5	198.437 5	223.837 5	249.237 5	274.637 5	300.037 5
53/64	0.828 125	21.034 4	46.434 4	71.834 4	97.234 4	122.634 4	148.034 4	173.434 4	198.834 4	224.234 4	249.634 4	275.034 4	300.434 4
27/32	0.843 75	21.431 2	46.831 2	72.231 2	97.631 2	123.031 2	148.431 2	173.831 2	199.231 2	224.631 2	250.031 2	275.431 2	300.831 2
55/64	0.859 375	21.828 1	47.228 1	72.628 1	98.028 1	123.428 1	148.828 1	174.228 1	199.628 1	225.028 1	250.428 1	275.828 1	301.228 1
7/8	0.875	22.225 0	47.625 0	73.025 0	98.425 0	123.825 0	149.225 0	174.625 0	200.025 0	225.425 0	250.825 0	276.225 0	301.625 0
57/64	0.890 625	22.621 9	48.021 9	73.421 9	98.821 9	124.221 9	149.621 9	175.021 9	200.421 9	225.821 9	251.221 9	276.621 9	302.021 9
29/32	0.906 25	23.018 8	48.418 8	73.818 8	99.218 8	124.618 8	150.018 8	175.41					

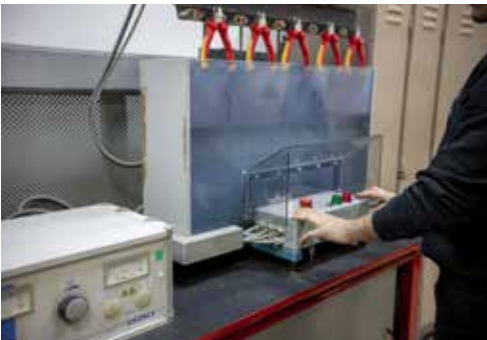
KALİTE GÜVENCE TESTLERİ / QUALITY ASSURANCE TEST



YASAL UYARILAR / LEGAL NOTIE

Bu katalog, önceki baskıların yerine geçer. Katalog içerisinde yer alan ürünlerin teknik özellikleri, görünümü, ölçüleri katalogun yayınlandığı tarihteki mevcut şartları temsil etmektedir. Bu sebeple sipariş verilmeden önce mutlaka firma ile iletişime geçerek sipariş tarihindeki ürünlere ilişkin güncel bilgileri öğrenmenizi öneririz. Katalogta belirtilen ürünlere ait teknik özellikler, görünüm veya ölçü gibi özelliklerin sipariş tarihindeki ürünler ile aynı olmamasından kaynaklı firmanın her ne nam altında olursa olsun hiçbir sorumluluğu bulunmamaktadır. Bu bilgiler doğrultusunda, firma işbu katalog içeriğinde yer alan bilgilerden veya görsel malzemeden kaynaklanabilecek hatalardan, maddi veya manevi zararlardan hiç bir şekil ve surette sorumlu değildir.

Firma katalog içeriğinde yer alan bilgiler veya ürünler ile ilgili önceden haber vermeksizin tek taraflı değişiklikler yapabilir. Firma dilediği zaman, ürünlerinin teknik özelliklerini, görsellerini veya ölçülerini veya ürünlerini tamamen veya kısmen değiştirme hakkına sahiptir. Kataloglarda yer alan görsellerde gözükken montaj, bağlantı detayları, kullanım alanları veya güvenlik önlemleri ürünlerin doğru kullanımı için bir örnek teşkil etmez. Ürünleri kullanan kişiler, katalog içeriğinde yer alan ürünler ile ilgili güvenlik uyarılarına ve ayrıca ürünlere ilişkin ek güvenlik/kullanım talimatlarına uymakla yükümlüdür, aksi takdirde ortaya çıkacak zararlardan firma hiçbir suretle sorumlu tutulamaz.

İşbu Katalog, tüm sayfaları, içeriğindeki bilgiler ve ürünler firmanın fikri ve sınai hakları kapsamında korunmaktadır. Ürün katalogu, içeriğindeki tüm bilgiler ile görseller ve ürünlere ilişkin telif hakkı İzeltaş İzmir El Aletleri Sanayi ve Ticaret A.Ş.'ye aittir. Firmanın yazılı izni olmadan işbu telif hakkına konu ürünlerin, bilgilerin, görsellerin veya katalogun izinsiz kullanılması, yayımlanması, üretilmesi, dağıtılması ve çoğaltılması yasaktır, aksi durum firmanın fikri ve sınai hakkın ihlali sonucunu doğuracaktır.

This catalog replaces previous editions.

The technical features, appearance and dimensions of the products in the catalog represent the current conditions at the date of publication of the catalog. For this reason, we recommend that you contact the company before ordering and learn the current information about the products on the order date. The company does not have any responsibility under any name due to the fact that the technical features, appearance or size of the products specified in the catalog are not the same as the products on the order date. In line with this information, the company is not responsible in any way or form for any errors, material or moral damages that may arise from the information or visual material contained in this catalogue.

The company may make unilateral changes regarding the information or products in the catalog without prior notice. The company reserves the right to change the technical specifications, images or dimensions of its products or products, in whole or in part, at any time. The assembly, connection details, usage areas or safety measures seen in the images in the catalogs do not constitute an example for the correct use of the products. Persons using the products are obliged to comply with the safety warnings regarding the products in the catalog content, as well as the additional safety / usage instructions regarding the products, otherwise the company cannot be held responsible for any damages that may arise.

This Catalog, all its pages, the information and products in it are protected within the scope of the intellectual and industrial rights of the company. The copyright of the product catalog, all the information in its content, images and products belongs to İzeltaş İzmir El Aletleri Sanayi ve Ticaret A.Ş. Unauthorized use, publication, production, distribution and reproduction of the products, information, images or catalog subject to this copyright without the written permission of the company is prohibited, otherwise it will result in violation of the intellectual and industrial rights of the company.

(★) İşaretili olan ürünler stoklarla sınırlıdır.

KOD	ÜRÜN	FİYAT	SAYFA			
				8244321005	TKD ÇKM5 KRMZ SYH TRND	4.470,60 24
8245321005	TKD ÇKM5 SYH PRM	7.261,75	7	8244321007	TKD ÇKM7 KRMZ SYH TRND	4.654,85 24
8245321007	TKD ÇKM7 SYH PRM	9.400,90	7	8244005096	TKD ÇKM5 KRMZ SET93 TRND	9.881,40 24
8245007096	TKD ÇKM7 SET243 PRM	26.005,25	7	8244007096	TKD ÇKM7 KRMZ SET93 TRND	10.065,65 24
8245001042	TKD 1.ÇKM SET42 PRM	3.210,15	8	8244001030	TKD 1.ÇKM SET30 TRND	1.529,05 25
8245002094	TKD 2.ÇKM SET91 PRM	3.525,80	8	8244002052	TKD 2.ÇKM SET49 TRND	2.282,10 25
8245003014	TKD 3.ÇKM SET14 PRM	1.635,30	8	8244003013	TKD 3.ÇKM SET13 TRND	1.599,65 25
8245004043	TKD 4.ÇKM SET43 PRM	1.863,05	9	8246321007	TKD AHŞAP ÜST TBL KRMZ ANT XXL	11.193,00 26
8245005043	TKD 5.ÇKM SET43 PRM	2.016,85	9	8247321007	TKD AHŞAP ÜST TBL KRMZ ANT WB	10.504,00 27
8245006009	TKD 6.ÇKM SET9 PRM	4.353,20	9	8210326001	TKD VGN	4.709,20 28
8241321005	TKD ÇKM5 GRİ KRMZ PROMOB	7.508,25	11	8160326001	TKD	4.247,10 29
8241321006	TKD ÇKM6 GRİ KRMZ PROMOB	8.113,40	11	8550348001	DMNT KÇK SRV ARB	2.023,75 30
8241321007	TKD ÇKM7 GRİ KRMZ PROMOB	9.587,95	11	8550348002	KAPA KÇK DMNT SRV ARB	2.333,80 30
8241321008	TKD ÇKM8 GRİ KRMZ PROMOB	10.220,30	11	8545341005	DMNT TARB	6.131,30 31
8241322005	TKD ÇKM5 GRİ MAVİ PROMOB	7.508,25	11	8550346001	BYK SRV ARB	3.360,85 31
8241322006	TKD ÇKM6 GRİ MAVİ PROMOB	8.113,40	11	8500346001	SRVMASA P	8.408,40 32
8241322007	TKD ÇKM7 GRİ MAVİ PROMOB	9.587,95	11	8501346001	SRVMASA	6.366,40 33
8241322008	TKD ÇKM8 GRİ MAVİ PROMOB	10.220,30	11	8502346002	DMNT ATLY MASA	21.496,20 34
8241323005	TKD ÇKM5 GRİ GRİ PROMOB	7.508,25	11	8320331001	ÇKM ALET SND KRMZ450	2.792,55 36
8241323006	TKD ÇKM6 GRİ GRİ PROMOB	8.113,40	11	8320331003	ÇKM ALET SND KRMZ650	3.055,65 36
8241323007	TKD ÇKM7 GRİ GRİ PROMOB	9.587,95	11	8410336103	TKÇ GÖZ3 300	356,00 37
8241323008	TKD ÇKM8 GRİ GRİ PROMOB	10.220,30	11	8410336203	TKÇ GÖZ3 420	425,55 37
8241001209	TKD ÇKM8 KRMZ SET206 PROMOB	22.591,50	11	8420336105	TKÇ GÖZ5 300	626,90 37
8241001030	TKD 1.ÇKM SET30 PROMOB	1.626,45	12	8420336205	TKÇ GÖZ5 420	649,10 37
8241002072	TKD 2.ÇKM SET69 PROMOB	3.195,35	12	8420336305	TKÇ GÖZ5 520	754,30 37
8241003051	TKD 3.ÇKM SET51 PROMOB	1.505,30	12	8420336405	TKÇ GÖZ5 600	794,85 37
8241004027	TKD 4.ÇKM SET27 PROMOB	2.640,85	13	8420005063	TKÇ GÖZ5 420 MKNK SET62	3.801,60 39
8241005010	TKD 5.ÇKM SET10 PROMOB	2.181,35	13	8420005046	TKÇ GÖZ5 420 ELKT SET45	4.320,95 39
8241006018	TKD 6.ÇKM SET18 PROMOB	1.221,90	13	8420005028	TKÇ GÖZ5 420 TSTÇ SET28	3.737,25 39
8242321005	TKD ÇKM5 KRMZ GRİ GRJ	6.708,85	15	8440331016	TKÇ PLS 16"	187,05 40
8242321006	TKD ÇKM6 KRMZ GRİ GRJ	7.896,75	15	8440331019	TKÇ PLS 19"	261,85 40
8242321007	TKD ÇKM7 KRMZ GRİ GRJ	9.226,45	15	8440331022	TKÇ PLS 22"	429,00 40
8242321008	TKD ÇKM8 KRMZ GRİ GRJ	10.128,60	15	8445331028	TKÇ PLS TKR 28"	1.034,05 40
8242322005	TKD ÇKM5 MAVİ GRİ GRJ	6.708,85	15	8705006113	OTO TİP HOB SET13	962,75 40
8242322006	TKD ÇKM6 MAVİ GRİ GRJ	7.896,75	15	8790008106	BKM ONRM SET5	692,20 40
8242322007	TKD ÇKM7 MAVİ GRİ GRJ	9.226,45	15	8793001014	BKM SET14	936,10 41
8242322008	TKD ÇKM8 MAVİ GRİ GRJ	10.128,60	15	8786001003	DĞD SET3	1.027,10 41
8242323005	TKD ÇKM5 GRİ GRİ GRJ	6.708,85	15	8779008741	MOTOSİKLET BKM SET42	1.281,25 41
8242323006	TKD ÇKM6 GRİ GRİ GRJ	7.896,75	15	100010405	2A ANH KB 0405	21,90 45
8242323007	TKD ÇKM7 GRİ GRİ GRJ	9.226,45	15	100010607	2A ANH KB 0607	22,35 45
8242323008	TKD ÇKM8 GRİ GRİ GRJ	10.128,60	15	100010809	2A ANH KB 0809	23,00 45
8242001142	TKD ÇKM7 KRMZ SET139 GRJ	18.422,70	15	100010810	2A ANH KB 0810	25,30 45
8242008142	TKD ÇKM8 KRMZ SET139 GRJ	19.324,85	15	100011011	2A ANH KB 1011	25,05 45
8242001030	TKD 1.ÇKM SET30 GRJ	1.626,45	16	100011012	2A ANH KB 1012	25,05 45
8242002072	TKD 2.ÇKM SET69 GRJ	3.195,35	16	100011013	2A ANH KB 1013	26,85 45
8242003010	TKD 3.ÇKM SET10 GRJ	2.181,35	17	100011213	2A ANH KB 1213	27,55 45
8242004018	TKD 4.ÇKM SET18 GRJ	1.221,90	17	100011214	2A ANH KB 1214	27,55 45
8242005011	TKD 5.ÇKM SET11 GRJ	971,20	17	100011314	2A ANH KB 1314	27,55 45
8235326005	TKD ÇKM5 KRMZ PART	6.103,70	19	100011415	2A ANH KB 1415	31,85 45
8235325005	TKD ÇKM5 MAVİ PART	6.103,70	19	100011317	2A ANH KB 1317	36,25 45
8235327005	TKD ÇKM5 SYH PART	6.103,70	19	100011417	2A ANH KB 1417	37,20 45
8235006121	TKD ÇKM5 KRMZ SET118 PART	12.872,65	19	100011617	2A ANH KB 1617	37,20 45
8235001072	TKD 1.ÇKM SET69 PART	3.603,30	20	100011719	2A ANH KB 1719	39,85 45
8235002031	TKD 2.ÇKM SET31 PART	1.620,60	21	100011819	2A ANH KB 1819	39,85 45
8235003017	TKD 3.ÇKM SET17 PART	1.545,05	21	100011922	2A ANH KB 1922	45,00 45
8243321003	TKD ÇKM3 KRMZ GRİ ECO	4.452,70	22	100012022	2A ANH KB 2022	46,60 45
8243321005	TKD ÇKM5 KRMZ GRİ ECO	4.452,70	22	100012123	2A ANH KB 2123	48,80 45
8243321007	TKD ÇKM7 KRMZ GRİ ECO	5.969,50	22	100012224	2A ANH KB 2224	50,90 45
8243322005	TKD ÇKM5 MAVİ GRİ ECO	4.452,70	22	100012426	2A ANH KB 2426	52,35 45
8243322007	TKD ÇKM7 MAVİ GRİ ECO	5.969,50	22	100012427	2A ANH KB 2427	52,35 45
8243323005	TKD ÇKM5 GRİ GRİ ECO	4.452,70	22	100012528	2A ANH KB 2528	65,10 45
8243323007	TKD ÇKM7 GRİ GRİ ECO	5.969,50	22	100012732	2A ANH KB 2732	77,55 45
8243001096	TKD ÇKM5 KRMZ SET93 ECO	9.863,50	22	100013032	2A ANH KB 3032	77,55 45
8243007096	TKD ÇKM7 KRMZ SET93 ECO	11.380,30	22	100010608	2A ANH KB 0608	24,90 45
8243001030	TKD 1.ÇKM SET30 ECO	1.529,05	23	100010708	2A ANH KB 0708	24,90 45
8243002052	TKD 2.ÇKM SET49 ECO	2.282,10	23	100010709	2A ANH KB 0709	24,90 45
8243003013	TKD 3.ÇKM SET13 ECO	1.599,65	23	100010910	2A ANH KB 0910	26,00 45

KOD	ÜRÜN	FİYAT	SAYFA	KOD	ÜRÜN	FİYAT	SAYFA
10001113	2A ANH KB 1113	27,55	45	161010811	2A ANH UB 5/16X7/16 SAE	35,35	47
10001114	2A ANH KB 1114	32,00	45	161010911	2A ANH UB 3/8X7/16 SAE	39,20	47
100011315	2A ANH KB 1315	31,85	45	161011112	2A ANH UB 7/16X1/2 SAE	39,20	47
100011722	2A ANH KB 1722	49,50	45	161011214	2A ANH UB 1/2X9/16 SAE	41,25	47
100011820	2A ANH KB 1820	49,50	45	161011416	2A ANH UB 9/16X5/8 SAE	47,95	47
100011822	2A ANH KB 1822	49,50	45	161011417	2A ANH UB 9/16X11/16 SAE	52,30	47
100011924	2A ANH KB 1924	51,55	45	161011517	2A ANH UB 19/32X11/16 SAE	52,80	47
100012226	2A ANH KB 2226	56,85	45	161011619	2A ANH UB 5/8X3/4 SAE	56,45	47
100012227	2A ANH KB 2227	56,85	45	161011920	2A ANH UB 3/4X25/32 SAE	56,45	47
100012430	2A ANH KB 2430	82,00	45	161012021	2A ANH UB 25/32X13/16 SAE	65,60	47
100012730	2A ANH KB 2730	82,00	45	161011922	2A ANH UB 3/4X7/8 SAE	65,60	47
100002108	2A ANH KB TK8	253,45	45	161012122	2A ANH UB 13/16X7/8 SAE	66,90	47
100002112	2A ANH KB TK12	497,25	45	161012325	2A ANH UB 15/16X1 SAE	78,85	47
130010607	2A ANH UB 0607	28,55	46	161012328	2A ANH UB 15/16X1-1/8 SAE	79,75	47
130010608	2A ANH UB 0608	29,55	46	161012628	2A ANH UB 1-1/16X1-1/8 SAE	114,60	47
130010809	2A ANH UB 0809	29,55	46	161012631	2A ANH UB 1-1/16X1-1/4 SAE	121,00	47
130010810	2A ANH UB 0810	29,55	46	161012833	2A ANH UB 1-1/8X1-5/16 SAE	121,00	47
130011011	2A ANH UB 1011	32,65	46	161002108	2A ANH UB TK8 SAE	412,85	47
130011012	2A ANH UB 1012	32,65	46	161002112	2A ANH UB TK12 SAE	735,30	47
130011013	2A ANH UB 1013	32,65	46	250010030	1A TAÇ ANH 30	131,20	48
130011014	2A ANH UB 1014	32,65	46	250010036	1A TAÇ ANH 36	165,65	48
130011113	2A ANH UB 1113	32,65	46	250010041	1A TAÇ ANH 41	216,25	48
130011114	2A ANH UB 1114	32,65	46	250010046	1A TAÇ ANH 46	232,75	48
130011213	2A ANH UB 1213	34,40	46	250010050	1A TAÇ ANH 50	290,65	48
130011214	2A ANH UB 1214	34,40	46	250010055	1A TAÇ ANH 55	389,35	48
130011314	2A ANH UB 1314	34,40	46	250010060	1A TAÇ ANH 60	498,60	48
130011315	2A ANH UB 1315	34,40	46	250010065	1A TAÇ ANH 65	607,85	48
130011415	2A ANH UB 1415	39,90	46	250010021	1A TAÇ ANH 21	0,00	48
130011317	2A ANH UB 1317	43,60	46	250010022	1A TAÇ ANH 22	0,00	48
130011417	2A ANH UB 1417	43,60	46	250010023	1A TAÇ ANH 23	0,00	48
130011617	2A ANH UB 1617	44,10	46	250010024	1A TAÇ ANH 24	0,00	48
130011618	2A ANH UB 1618	47,05	46	250010025	1A TAÇ ANH 25	0,00	48
130011719	2A ANH UB 1719	47,05	46	250010027	1A TAÇ ANH 27	0,00	48
130011819	2A ANH UB 1819	47,05	46	250010032	1A TAÇ ANH 32	0,00	48
130011921	2A ANH UB 1921	54,80	46	250010034	1A TAÇ ANH 34	0,00	48
130011922	2A ANH UB 1922	54,80	46	250010038	1A TAÇ ANH 38	0,00	48
130012022	2A ANH UB 2022	54,80	46	250010070	1A TAÇ ANH 70	0,00	48
130011924	2A ANH UB 1924	55,05	46	250010075	1A TAÇ ANH 75	0,00	48
130012123	2A ANH UB 2123	55,90	46	325020010	MNT ANH 10	49,15	48
130012224	2A ANH UB 2224	59,40	46	325020013	MNT ANH 13	55,05	48
130012426	2A ANH UB 2426	68,00	46	325020017	MNT ANH 17	72,80	48
130012427	2A ANH UB 2427	68,00	46	325020019	MNT ANH 19	85,25	48
130012430	2A ANH UB 2430	76,05	46	325020020	MNT ANH 20	86,85	48
130012528	2A ANH UB 2528	76,05	46	325020021	MNT ANH 21	100,95	48
130012729	2A ANH UB 2729	95,00	46	325020022	MNT ANH 22	115,60	48
130012730	2A ANH UB 2730	95,00	46	255010010	1A SPR İZL ANH 10	76,75	48
130012732	2A ANH UB 2732	95,00	46	255010011	1A SPR İZL ANH 11	81,05	48
130013032	2A ANH UB 3032	95,00	46	255010012	1A SPR İZL ANH 12	84,65	48
130013036	2A ANH UB 3036	180,10	46	255010013	1A SPR İZL ANH 13	91,10	48
130013236	2A ANH UB 3236	180,10	46	255010014	1A SPR İZL ANH 14	94,55	48
130013436	2A ANH UB 3436	180,10	46	255010017	1A SPR İZL ANH 17	116,05	48
130013641	2A ANH UB 3641	279,75	46	255010019	1A SPR İZL ANH 19	136,20	48
130014146	2A ANH UB 4146	431,30	46	255010022	1A SPR İZL ANH 22	183,20	48
130014650	2A ANH UB 4650	478,35	46	255010024	1A SPR İZL ANH 24	224,15	48
130010555	2A ANH UB 05X5,5	22,35	46	320020005	KMB ANH KB 05	28,55	49
130010708	2A ANH UB 0708	29,55	46	320020055	KMB ANH KB 5,5	28,55	49
130010709	2A ANH UB 0709	29,55	46	320020006	KMB ANH KB 06	29,55	49
130010910	2A ANH UB 0910	32,65	46	320020007	KMB ANH KB 07	31,40	49
130010911	2A ANH UB 0911	32,65	46	320020008	KMB ANH KB 08	34,20	49
130011722	2A ANH UB 1722	54,80	46	320020009	KMB ANH KB 09	34,95	49
130011724	2A ANH UB 1724	55,05	46	320020010	KMB ANH KB 10	39,45	49
130012227	2A ANH UB 2227	68,00	46	320020011	KMB ANH KB 11	40,45	49
130002108	2A ANH UB TK8	311,00	46	320020012	KMB ANH KB 12	43,15	49
130002112	2A ANH UB TK12	605,95	46	320020013	KMB ANH KB 13	44,10	49
161010608	2A ANH UB 1/4X5/16 SAE	35,35	47	320020014	KMB ANH KB 14	47,70	49
161010809	2A ANH UB 5/16X3/8 SAE	35,35	47	320020015	KMB ANH KB 15	51,05	49
161010810	2A ANH UB 5/16X11/32 SAE	35,35	47	320020016	KMB ANH KB 16	54,80	49

KOD	ÜRÜN	FİYAT	SAYFA	KOD	ÜRÜN	FİYAT	SAYFA
320020017	KMB ANH KB 17	58,40	49	331020017	KMB ANH UB 11/16 SAE	82,35	51
320020018	KMB ANH KB 18	65,15	49	331020019	KMB ANH UB 3/4 SAE	95,90	51
320020019	KMB ANH KB 19	68,55	49	331020020	KMB ANH UB 25/32 SAE	102,60	51
320020020	KMB ANH KB 20	69,85	49	331020021	KMB ANH UB 13/16 SAE	113,30	51
320020021	KMB ANH KB 21	81,05	49	331020022	KMB ANH UB 7/8 SAE	130,50	51
320020022	KMB ANH KB 22	92,50	49	331020024	KMB ANH UB 15/16 SAE	159,65	51
320020023	KMB ANH KB 23	92,50	49	331020025	KMB ANH UB 1 SAE	159,65	51
320020024	KMB ANH KB 24	113,25	49	331020027	KMB ANH UB 1-1/16 SAE	186,85	51
320020025	KMB ANH KB 25	113,25	49	331020028	KMB ANH UB 1-1/8 SAE	186,85	51
320020026	KMB ANH KB 26	133,40	49	331020030	KMB ANH UB 1-3/16 SAE	214,05	51
320020027	KMB ANH KB 27	133,40	49	331020032	KMB ANH UB 1-1/4 SAE	224,35	51
320020028	KMB ANH KB 28	133,40	49	331020033	KMB ANH UB 1-5/16 SAE	224,35	51
320020029	KMB ANH KB 29	152,75	49	331020038	KMB ANH UB 1-1/2 SAE	271,20	51
320020030	KMB ANH KB 30	152,75	49	331020035	KMB ANH UB 1-3/8 SAE	246,55	51
320020032	KMB ANH KB 32	160,60	49	331020036	KMB ANH UB 1-7/16 SAE	246,55	51
320020034	KMB ANH KB 34	167,75	49	331020041	KMB ANH UB 1-5/8 SAE	287,40	51
32002108	KMB ANH KB TK8	340,60	49	331020046	KMB ANH UB 1-13/16 SAE	390,65	51
32002112	KMB ANH KB TK12	609,30	49	331020050	KMB ANH UB 2 SAE	529,70	51
32002117	KMB ANH KB TK17	886,30	49	33102108	KMB ANH UB TK8 SAE	547,55	51
32002121	KMB ANH KB TK21	1.446,30	49	33102112	KMB ANH UB TK12 SAE	1.110,65	51
330020005	KMB ANH UB 05	32,90	50	33102117	KMB ANH UB TK17 SAE	1.727,15	51
330020055	KMB ANH UB 5,5	32,90	50	33102120	KMB ANH UB TK20 SAE	2.362,70	51
330020006	KMB ANH UB 06	32,90	50	340020008	CRC KMB ANH 08	140,05	52
330020007	KMB ANH UB 07	32,90	50	340020009	CRC KMB ANH 09	139,75	52
330020008	KMB ANH UB 08	38,50	50	340020010	CRC KMB ANH 10	146,60	52
330020009	KMB ANH UB 09	39,00	50	340020011	CRC KMB ANH 11	147,35	52
330020010	KMB ANH UB 10	43,15	50	340020012	CRC KMB ANH 12	159,65	52
330020011	KMB ANH UB 11	45,60	50	340020013	CRC KMB ANH 13	171,10	52
330020012	KMB ANH UB 12	45,60	50	340020014	CRC KMB ANH 14	176,25	52
330020013	KMB ANH UB 13	51,10	50	340020015	CRC KMB ANH 15	186,85	52
330020014	KMB ANH UB 14	53,20	50	340020016	CRC KMB ANH 16	214,10	52
330020015	KMB ANH UB 15	56,80	50	340020017	CRC KMB ANH 17	226,60	52
330020016	KMB ANH UB 16	57,35	50	340020018	CRC KMB ANH 18	245,65	52
330020017	KMB ANH UB 17	65,15	50	340020019	CRC KMB ANH 19	260,90	52
330020018	KMB ANH UB 18	70,30	50	340020021	CRC KMB ANH 21	363,05	52
330020019	KMB ANH UB 19	76,35	50	340020022	CRC KMB ANH 22	398,15	52
330020020	KMB ANH UB 20	81,25	50	340020024	CRC KMB ANH 24	449,75	52
330020021	KMB ANH UB 21	86,35	50	335020010	ÇOK YLD CRC ANH 10X13X17X19	519,20	52
330020022	KMB ANH UB 22	102,95	50	34002110	CRC KMB ANH TK10	1.755,10	52
330020023	KMB ANH UB 23	125,65	50	34002115	CRC KMB ANH TK15	3.425,80	52
330020024	KMB ANH UB 24	125,65	50	345020008	MFSL CRC KMB ANH 08	231,80	53
330020025	KMB ANH UB 25	125,65	50	345020009	MFSL CRC KMB ANH 09	236,40	53
330020026	KMB ANH UB 26	148,00	50	345020010	MFSL CRC KMB ANH 10	245,90	53
330020027	KMB ANH UB 27	148,00	50	345020011	MFSL CRC KMB ANH 11	253,65	53
330020028	KMB ANH UB 28	148,00	50	345020012	MFSL CRC KMB ANH 12	268,10	53
330020029	KMB ANH UB 29	148,00	50	345020013	MFSL CRC KMB ANH 13	279,60	53
330020030	KMB ANH UB 30	169,95	50	345020014	MFSL CRC KMB ANH 14	294,05	53
330020032	KMB ANH UB 32	178,20	50	345020015	MFSL CRC KMB ANH 15	308,55	53
330020034	KMB ANH UB 34	181,65	50	345020016	MFSL CRC KMB ANH 16	335,70	53
330020036	KMB ANH UB 36	205,80	50	345020017	MFSL CRC KMB ANH 17	340,10	53
330020038	KMB ANH UB 38	210,60	50	345020018	MFSL CRC KMB ANH 18	366,20	53
330020041	KMB ANH UB 41	239,65	50	345020019	MFSL CRC KMB ANH 19	382,60	53
330020046	KMB ANH UB 46	325,60	50	345002112	MFSL CRC KMB ANH TK12	3.542,65	53
330020050	KMB ANH UB 50	441,50	50	370020006	BYN KMB ANH 06	33,95	54
330002108	KMB ANH UB TK8	379,05	50	370020007	BYN KMB ANH 07	36,20	54
330002112	KMB ANH UB TK12	674,75	50	370020008	BYN KMB ANH 08	39,20	54
330002117	KMB ANH UB TK17	978,45	50	370020009	BYN KMB ANH 09	40,10	54
330002121	KMB ANH UB TK21	1.600,25	50	370020010	BYN KMB ANH 10	45,40	54
331020005	KMB ANH UB 3/16 SAE	39,45	51	370020011	BYN KMB ANH 11	46,75	54
331020006	KMB ANH UB 1/4 SAE	41,10	51	370020012	BYN KMB ANH 12	50,15	54
331020008	KMB ANH UB 5/16 SAE	47,85	51	370020013	BYN KMB ANH 13	51,40	54
331020010	KMB ANH UB 3/8 SAE	54,55	51	370020014	BYN KMB ANH 14	55,05	54
331020011	KMB ANH UB 7/16 SAE	57,25	51	370020015	BYN KMB ANH 15	58,60	54
331020013	KMB ANH UB 1/2 SAE	64,55	51	370020016	BYN KMB ANH 16	62,95	54
331020014	KMB ANH UB 9/16 SAE	67,85	51	370020017	BYN KMB ANH 17	67,15	54
331020015	KMB ANH UB 19/32 SAE	71,90	51	370020018	BYN KMB ANH 18	74,95	54
331020016	KMB ANH UB 5/8 SAE	77,25	51	370020019	BYN KMB ANH 19	78,85	54

KOD	ÜRÜN	FİYAT	SAYFA	KOD	ÜRÜN	FİYAT	SAYFA
370020020	BYN KMB ANH 20	82,85	54	430031315	2A YLD ANH SB 1315	68,55	56
370020021	BYN KMB ANH 21	93,15	54	430032227	2A YLD ANH SB 2227	135,25	56
370020022	BYN KMB ANH 22	106,65	54	430033034	2A YLD ANH SB 3034	216,35	56
370020023	BYN KMB ANH 23	130,35	54	43002108	2A YLD ANH SB TK8	565,15	56
370020024	BYN KMB ANH 24	130,35	54	43002112	2A YLD ANH SB TK12	1.127,20	56
370020025	BYN KMB ANH 25	130,35	54	431030608	2A YLD ANH SB 1/4X5/16 SAE	63,20	57
370020026	BYN KMB ANH 26	153,35	54	431030809	2A YLD ANH SB 5/16X3/8 SAE	65,60	57
370020027	BYN KMB ANH 27	153,35	54	431030811	2A YLD ANH SB 5/16X7/16 SAE	68,75	57
370020028	BYN KMB ANH 28	153,35	54	431030911	2A YLD ANH SB 3/8X7/16 SAE	72,35	57
370020029	BYN KMB ANH 29	170,85	54	431031112	2A YLD ANH SB 7/16X1/2 SAE	78,10	57
370020030	BYN KMB ANH 30	176,10	54	431031214	2A YLD ANH SB 1/2X9/16 SAE	82,35	57
370020032	BYN KMB ANH 32	184,80	54	431031415	2A YLD ANH SB 9/16X19/32 SAE	82,35	57
370020036	BYN KMB ANH 36	213,60	54	431031416	2A YLD ANH SB 9/16X5/8 SAE	83,05	57
37002108	BYN KMB ANH TK8	392,25	54	431031517	2A YLD ANH SB 19/32X11/16 SAE	93,15	57
37002112	BYN KMB ANH TK12	702,25	54	431031920	2A YLD ANH SB 3/4X25/32 SAE	115,60	57
37002117	BYN KMB ANH TK17	1.023,35	54	431032122	2A YLD ANH SB 13/16X7/8 SAE	139,10	57
37002121	BYN KMB ANH TK21	1.667,95	54	431032325	2A YLD ANH SB 15/16X1 SAE	162,15	57
380020008	TORX KMB ANH 08	68,30	55	431032631	2A YLD ANH SB 1-1/16X1-1/4 SAE	195,35	57
380020009	TORX KMB ANH 09	69,40	55	431032833	2A YLD ANH SB 1-1/8X1-5/16 SAE	195,35	57
380020010	TORX KMB ANH 10	76,95	55	431033033	2A YLD ANH SB 1-3/16X1-5/16 SAE	208,35	57
380020011	TORX KMB ANH 11	81,10	55	431031217	2A YLD ANH SB 1/2X11/16 SAE	93,15	57
380020012	TORX KMB ANH 12	83,30	55	431031417	2A YLD ANH SB 9/16x11/16 SAE	93,15	57
380020013	TORX KMB ANH 13	91,40	55	431031617	2A YLD ANH SB 5/8X11/16 SAE	93,15	57
380020014	TORX KMB ANH 14	101,15	55	431031619	2A YLD ANH SB 5/8X3/4 SAE	111,00	57
380020015	TORX KMB ANH 15	107,05	55	431032021	2A YLD ANH SB 25/32X13/16 SAE	121,35	57
380020017	TORX KMB ANH 17	116,25	55	431031922	2A YLD ANH SB 3/4X7/8 SAE	121,35	57
380020018	TORX KMB ANH 18	126,10	55	431032223	2A YLD ANH SB 7/8X15/16 SAE	139,10	57
380020019	TORX KMB ANH 19	136,60	55	431032328	2A YLD ANH SB 15/16x1-1/8 SAE	162,15	57
380020022	TORX KMB ANH 22	183,65	55	431032528	2A YLD ANH SB 1X1-1/8 SAE	177,45	57
38002108	TORX KMB ANH TK8	723,30	55	431033036	2A YLD ANH SB 1-3/16 X1-3/8 SAE	301,05	57
38002112	TORX KMB ANH TK12	1.241,25	55	431033236	2A YLD ANH SB 1-1/4X1-7/16 SAE	301,05	57
430030607	2A YLD ANH SB 0607	51,10	56	431033641	2A YLD ANH SB 1-7/16X1-5/8 SAE	409,25	57
430030809	2A YLD ANH SB 0809	51,85	56	431034146	2A YLD ANH SB 1-11/16X1-7/8 SAE	560,45	57
430030810	2A YLD ANH SB 0810	51,85	56	431034650	2A YLD ANH SB 1-13/16X2 SAE	891,85	57
430031011	2A YLD ANH SB 1011	57,35	56	431002108	2A YLD ANH SB TK8 SAE	799,95	57
430031012	2A YLD ANH SB 1012	57,35	56	431002112	2A YLD ANH SB TK12 SAE	1.471,35	57
430031013	2A YLD ANH SB 1013	65,15	56	440030607	2A DÜZ YLD ANH SB 0607	47,05	58
430031113	2A YLD ANH SB 1113	65,15	56	440030809	2A DÜZ YLD ANH SB 0809	49,15	58
430031213	2A YLD ANH SB 1213	65,15	56	440031011	2A DÜZ YLD ANH SB 1011	54,55	58
430031214	2A YLD ANH SB 1214	65,15	56	440031213	2A DÜZ YLD ANH SB 1213	58,85	58
430031415	2A YLD ANH SB 1415	68,55	56	440031415	2A DÜZ YLD ANH SB 1415	68,55	58
430031317	2A YLD ANH SB 1317	77,65	56	440031617	2A DÜZ YLD ANH SB 1617	81,25	58
430031417	2A YLD ANH SB 1417	77,65	56	440031819	2A DÜZ YLD ANH SB 1819	84,90	58
430031617	2A YLD ANH SB 1617	77,65	56	440032022	2A DÜZ YLD ANH SB 2022	98,60	58
430031618	2A YLD ANH SB 1618	92,25	56	440032123	2A DÜZ YLD ANH SB 2123	116,80	58
430031719	2A YLD ANH SB 1719	92,25	56	440032426	2A DÜZ YLD ANH SB 2426	118,25	58
430031819	2A YLD ANH SB 1819	92,25	56	440032528	2A DÜZ YLD ANH SB 2528	138,15	58
430031922	2A YLD ANH SB 1922	101,25	56	440032732	2A DÜZ YLD ANH SB 2732	170,65	58
430031924	2A YLD ANH SB 1924	101,25	56	440030810	2A DÜZ YLD ANH SB 0810	52,65	58
430032022	2A YLD ANH SB 2022	101,25	56	440031013	2A DÜZ YLD ANH SB 1013	58,85	58
430032123	2A YLD ANH SB 2123	116,05	56	440031315	2A DÜZ YLD ANH SB 1315	68,55	58
430032224	2A YLD ANH SB 2224	116,05	56	440031317	2A DÜZ YLD ANH SB 1317	81,25	58
430032426	2A YLD ANH SB 2426	135,25	56	440031618	2A DÜZ YLD ANH SB 1618	84,90	58
430032427	2A YLD ANH SB 2427	135,25	56	440031719	2A DÜZ YLD ANH SB 1719	84,90	58
430032430	2A YLD ANH SB 2430	148,00	56	440032224	2A DÜZ YLD ANH SB 2224	116,80	58
430032528	2A YLD ANH SB 2528	148,00	56	440032427	2A DÜZ YLD ANH SB 2427	118,25	58
430032729	2A YLD ANH SB 2729	162,75	56	440032729	2A DÜZ YLD ANH SB 2729	157,85	58
430032730	2A YLD ANH SB 2730	162,75	56	440033032	2A DÜZ YLD ANH SB 3032	170,65	58
430032732	2A YLD ANH SB 2732	162,75	56	44002108	2A DÜZ YLD ANH SB TK8	542,90	58
430033032	2A YLD ANH SB 3032	162,75	56	44002112	2A DÜZ YLD ANH SB TK12	1.086,75	58
430033036	2A YLD ANH SB 3036	251,05	56	435030010	1A SPR İZL YLD ANH SB 10	102,30	59
430033236	2A YLD ANH SB 3236	251,05	56	435030011	1A SPR İZL YLD ANH SB 11	102,30	59
430033436	2A YLD ANH SB 3436	306,85	56	435030012	1A SPR İZL YLD ANH SB 12	116,05	59
430033641	2A YLD ANH SB 3641	340,95	56	435030013	1A SPR İZL YLD ANH SB 13	116,05	59
430034146	2A YLD ANH SB 4146	467,20	56	435030014	1A SPR İZL YLD ANH SB 14	121,80	59
430034650	2A YLD ANH SB 4650	743,40	56	435030017	1A SPR İZL YLD ANH SB 17	138,00	59
430031014	2A YLD ANH SB 1014	65,15	56	435030019	1A SPR İZL YLD ANH SB 19	164,65	59

KOD	ÜRÜN	FİYAT	SAYFA	KOD	ÜRÜN	FİYAT	SAYFA
435030022	1A SPR IZL YLD ANH SB 22	180,50	59	750050055	YLD ÇAK ANH 55	824,00	60
435030024	1A SPR IZL YLD ANH SB 24	241,15	59	750050060	YLD ÇAK ANH 60	894,10	60
540010810	2A RKR ANH 0810	92,10	59	750050065	YLD ÇAK ANH 65	1.168,85	60
540011011	2A RKR ANH 1011	95,60	59	750050070	YLD ÇAK ANH 70	1.338,05	60
540011012	2A RKR ANH 1012	95,60	59	750050075	YLD ÇAK ANH 75	1.432,15	60
540011113	2A RKR ANH 1113	102,40	59	750050080	YLD ÇAK ANH 80	2.034,35	60
540011214	2A RKR ANH 1214	102,40	59	750050085	YLD ÇAK ANH 85	2.288,85	60
540011719	2A RKR ANH 1719	182,75	59	750050090	YLD ÇAK ANH 90	2.815,45	60
540011922	2A RKR ANH 1922	218,80	59	750050095	YLD ÇAK ANH 95	3.174,75	60
530040810	YRM AY YLD ANH 0810	60,65	59	750050100	YLD ÇAK ANH 100	3.670,15	60
530041011	YRM AY YLD ANH 1011	71,20	59	750050105	YLD ÇAK ANH 105	3.788,50	60
530041012	YRM AY YLD ANH 1012	71,20	59	750050110	YLD ÇAK ANH 110	4.049,95	60
530041113	YRM AY YLD ANH 1113	71,20	59	750050115	YLD ÇAK ANH 115	4.539,75	60
530041315	YRM AY YLD ANH 1315	84,80	59	750050120	YLD ÇAK ANH 120	6.239,30	60
530041317	YRM AY YLD ANH 1317	84,80	59	750050125	YLD ÇAK ANH 125	0,00	60
530041417	YRM AY YLD ANH 1417	84,80	59	750050130	YLD ÇAK ANH 130	0,00	60
530041517	YRM AY YLD ANH 1517	84,80	59	750050135	YLD ÇAK ANH 135	0,00	60
530041922	YRM AY YLD ANH 1922	110,35	59	750050140	YLD ÇAK ANH 140	0,00	60
531041112	YRM AY YLD ANH 7/16X1/2 SAE	87,75	59	750050145	YLD ÇAK ANH 145	0,00	60
531041214	YRM AY YLD ANH 1/2X9/16 SAE	102,05	59	750050150	YLD ÇAK ANH 150	0,00	60
531041416	YRM AY YLD ANH 9/16X5/8 SAE	105,15	59	750050155	YLD ÇAK ANH 155	0,00	60
531041922	YRM AY YLD ANH 3/4X7/8 SAE	132,50	59	750050160	YLD ÇAK ANH 160	0,00	60
531040809	YRM AY YLD ANH 5/16X3/8 SAE	72,60	59	750050165	YLD ÇAK ANH 165	0,00	60
531040911	YRM AY YLD ANH 3/8X7/16 SAE	85,45	59	750050170	YLD ÇAK ANH 170	0,00	60
531041417	YRM AY YLD ANH 9/16X11/16 SAE	101,65	59	750050180	YLD ÇAK ANH 180	0,00	60
700050024	ÇTL ÇAK ANH 24	122,25	60	550050024	BORU UZT YLD ANH 24	179,10	61
700050027	ÇTL ÇAK ANH 27	151,75	60	550050027	BORU UZT YLD ANH 27	213,40	61
700050030	ÇTL ÇAK ANH 30	186,40	60	550050030	BORU UZT YLD ANH 30	254,85	61
700050032	ÇTL ÇAK ANH 32	209,25	60	550050032	BORU UZT YLD ANH 32	292,70	61
700050036	ÇTL ÇAK ANH 36	234,95	60	550050036	BORU UZT YLD ANH 36	331,10	61
700050038	ÇTL ÇAK ANH 38	282,85	60	550050038	BORU UZT YLD ANH 38	382,05	61
700050041	ÇTL ÇAK ANH 41	307,10	60	550050041	BORU UZT YLD ANH 41	432,75	61
700050042	ÇTL ÇAK ANH 42	354,85	60	550050046	BORU UZT YLD ANH 46	517,85	61
700050046	ÇTL ÇAK ANH 46	390,55	60	550050050	BORU UZT YLD ANH 50	611,40	61
700050047	ÇTL ÇAK ANH 47	456,10	60	550050055	BORU UZT YLD ANH 55	859,85	61
700050050	ÇTL ÇAK ANH 50	488,00	60	550050060	BORU UZT YLD ANH 60	933,20	61
700050055	ÇTL ÇAK ANH 55	654,05	60	550050065	BORU UZT YLD ANH 65	1.010,40	61
700050060	ÇTL ÇAK ANH 60	710,10	60	550050022	BORU UZT YLD ANH 22	0,00	61
700050065	ÇTL ÇAK ANH 65	1.021,45	60	550050034	BORU UZT YLD ANH 34	0,00	61
700050070	ÇTL ÇAK ANH 70	1.307,65	60	550050070	BORU UZT YLD ANH 70	0,00	61
700050075	ÇTL ÇAK ANH 75	1.385,45	60	550050075	BORU UZT YLD ANH 75	0,00	61
700050080	ÇTL ÇAK ANH 80	1.761,95	60	550050080	BORU UZT YLD ANH 80	0,00	61
700050085	ÇTL ÇAK ANH 85	2.335,65	60	550050085	BORU UZT YLD ANH 85	0,00	61
700050090	ÇTL ÇAK ANH 90	2.403,10	60	550050090	BORU UZT YLD ANH 90	0,00	61
700050095	ÇTL ÇAK ANH 95	2.562,70	60	550050095	BORU UZT YLD ANH 95	0,00	61
700050100	ÇTL ÇAK ANH 100	3.632,15	60	550050100	BORU UZT YLD ANH 100	0,00	61
700050105	ÇTL ÇAK ANH 105	3.745,45	60	551050001	DNDR KOL BORU 22-30	163,95	61
700050110	ÇTL ÇAK ANH 110	4.273,70	60	551050002	DNDR KOL BORU 32-41	222,15	61
700050115	ÇTL ÇAK ANH 115	4.909,40	60	551050003	DNDR KOL BORU 46-55	333,05	61
700050120	ÇTL ÇAK ANH 120	5.182,05	60	551050004	DNDR KOL BORU 60-100	449,50	61
700050125	ÇTL ÇAK ANH 125	0,00	60	600011006	KURB ANH 6"	164,75	61
700050130	ÇTL ÇAK ANH 130	0,00	60	600011008	KURB ANH 8"	205,95	61
700050135	ÇTL ÇAK ANH 135	0,00	60	600011010	KURB ANH 10"	265,45	61
700050140	ÇTL ÇAK ANH 140	0,00	60	600011012	KURB ANH 12"	366,85	61
700050145	ÇTL ÇAK ANH 145	0,00	60	600011015	KURB ANH 15"	575,00	61
700050150	ÇTL ÇAK ANH 150	0,00	60	860052528	KNC ANH 4GEN UÇ 25/28	85,90	61
750050024	YLD ÇAK ANH 24	171,35	60	860053032	KNC ANH 4GEN UÇ 30/32	85,90	61
750050027	YLD ÇAK ANH 27	204,50	60	860053436	KNC ANH 4GEN UÇ 34/36	92,90	61
750050030	YLD ÇAK ANH 30	244,10	60	860054042	KNC ANH 4GEN UÇ 40/42	92,90	61
750050032	YLD ÇAK ANH 32	280,40	60	860054550	KNC ANH 4GEN UÇ 45/50	107,65	61
750050036	YLD ÇAK ANH 36	317,35	60	860055255	KNC ANH 4GEN UÇ 52/55	107,65	61
750050038	YLD ÇAK ANH 38	380,05	60	860055862	KNC ANH 4GEN UÇ 58/62	129,85	61
750050041	YLD ÇAK ANH 41	414,85	60	860056875	KNC ANH 4GEN UÇ 68/75	129,85	61
750050042	YLD ÇAK ANH 42	474,40	60	860058090	KNC ANH 4GEN UÇ 80/90	169,45	61
750050046	YLD ÇAK ANH 46	496,10	60	860059510	KNC ANH 4GEN UÇ 95/100	169,45	61
750050047	YLD ÇAK ANH 47	547,40	60	615010200	AYR MNT ANH 200	264,75	62
750050050	YLD ÇAK ANH 50	585,75	60	1107060004	1/4" GKŞ LKM ANH 04	9,25	69

KOD	ÜRÜN	FIYAT	SAYFA	KOD	ÜRÜN	FIYAT	SAYFA
1107060045	1/4" 6KŞ LKM ANH 4,5	9,25	69	1507064115	1/4" T KOL	41,75	71
1107060005	1/4" 6KŞ LKM ANH 05	9,25	69	1507062140	1/4" CRC KOL 140	166,25	72
1107060055	1/4" 6KŞ LKM ANH 5,5	9,25	69	1507066140	1/4" MAND CRC KOL 140	237,90	72
1107060006	1/4" 6KŞ LKM ANH 06	9,25	69	1507062150	1/4" MFSL CRC KOL 72DİŞ 150	551,40	72
1107060007	1/4" 6KŞ LKM ANH 07	9,25	69	1507062110	1/4" CRC KOL 72DİŞ LKM&BITS TUTC 110	346,00	72
1107060008	1/4" 6KŞ LKM ANH 08	9,25	69	1507067115	1/4" MFSL T CRC KOL 72DİŞ 115	529,80	72
1107060009	1/4" 6KŞ LKM ANH 09	10,05	69	1507060004	1/4"FX3/8"M LKM ADP	21,45	73
1107060010	1/4" 6KŞ LKM ANH 10	10,05	69	1507064080	1/4" DRN LKM TRNV ADP	49,35	73
1107060011	1/4" 6KŞ LKM ANH 11	12,80	69	1107065010	1/4" BITS TUTC LKM MIKN	34,35	73
1107060012	1/4" 6KŞ LKM ANH 12	12,80	69	1107060015	1/4" 6KŞ LKM ANH SET15	405,35	73
1107060013	1/4" 6KŞ LKM ANH 13	14,50	69	1110060006	3/8" 6KŞ LKM ANH 06	23,95	74
1107064004	1/4" 6KŞ DRN LKM ANH 04	18,00	69	1110060007	3/8" 6KŞ LKM ANH 07	23,95	74
1107064005	1/4" 6KŞ DRN LKM ANH 05	18,00	69	1110060008	3/8" 6KŞ LKM ANH 08	23,95	74
1107064005	1/4" 6KŞ DRN LKM ANH 5,5	18,00	69	1110060009	3/8" 6KŞ LKM ANH 09	23,95	74
1107064006	1/4" 6KŞ DRN LKM ANH 06	20,20	69	1110060010	3/8" 6KŞ LKM ANH 10	23,95	74
1107064007	1/4" 6KŞ DRN LKM ANH 07	20,20	69	1110060011	3/8" 6KŞ LKM ANH 11	23,95	74
1107064008	1/4" 6KŞ DRN LKM ANH 08	20,20	69	1110060012	3/8" 6KŞ LKM ANH 12	23,95	74
1107064009	1/4" 6KŞ DRN LKM ANH 09	21,70	69	1110060013	3/8" 6KŞ LKM ANH 13	25,60	74
1107064010	1/4" 6KŞ DRN LKM ANH 10	21,70	69	1110060014	3/8" 6KŞ LKM ANH 14	25,60	74
1107064011	1/4" 6KŞ DRN LKM ANH 11	23,30	69	1110060015	3/8" 6KŞ LKM ANH 15	25,60	74
1107064012	1/4" 6KŞ DRN LKM ANH 12	23,30	69	1110060016	3/8" 6KŞ LKM ANH 16	26,75	74
1107064013	1/4" 6KŞ DRN LKM ANH 13	23,30	69	1110060017	3/8" 6KŞ LKM ANH 17	26,75	74
1107060014	1/4" 6KŞ DRN LKM ANH SET14	442,50	69	1110060018	3/8" 6KŞ LKM ANH 18	27,80	74
1107061125	1/4" ALLEN UÇ LKM ANH 2,5	15,45	70	1110060019	3/8" 6KŞ LKM ANH 19	32,00	74
1107061103	1/4" ALLEN UÇ LKM ANH 03	15,45	70	1110060021	3/8" 6KŞ LKM ANH 21	36,20	74
1107061104	1/4" ALLEN UÇ LKM ANH 04	15,45	70	1110060022	3/8" 6KŞ LKM ANH 22	38,65	74
1107061105	1/4" ALLEN UÇ LKM ANH 05	15,45	70	1110060023	3/8" 6KŞ LKM ANH 23	38,65	74
1107061106	1/4" ALLEN UÇ LKM ANH 06	15,45	70	1110069208	3/8" BUJİ LKM LSTK 20,8	50,35	74
1107061107	1/4" ALLEN UÇ LKM ANH 07	18,25	70	1510060200	3/8" CRC KOL 200	281,50	74
1107061108	1/4" ALLEN UÇ LKM ANH 08	18,25	70	1510060075	3/8" ARA KOL 75	42,75	74
1107061110	1/4" ALLEN UÇ LKM ANH 10	22,00	70	1510060150	3/8" ARA KOL 150	64,65	74
1107061208	1/4" TORX UÇ LKM ANH T8	15,95	70	1510060056	3/8" MFSL 56,5	69,40	74
1107061209	1/4" TORX UÇ LKM ANH T9	15,95	70	1510061200	3/8" T KOL	99,75	75
1107061210	1/4" TORX UÇ LKM ANH T10	15,95	70	1510060007	3/8"FX1/2M" LKM ADP	47,60	75
1107061215	1/4" TORX UÇ LKM ANH T15	15,95	70	1110006019	3/8" 6KŞ LKM SET19	960,85	75
1107061220	1/4" TORX UÇ LKM ANH T20	15,95	70	1113006145	1/2" LKM ANH&SHP SET146	7.182,10	76
1107061225	1/4" TORX UÇ LKM ANH T25	15,95	70	1113061008	1/2" 6KŞ LKM ANH 08	30,85	76
1107061227	1/4" TORX UÇ LKM ANH T27	15,95	70	1113061009	1/2" 6KŞ LKM ANH 09	30,85	76
1107061230	1/4" TORX UÇ LKM ANH T30	15,95	70	1113061010	1/2" 6KŞ LKM ANH 10	38,30	76
1107061240	1/4" TORX UÇ LKM ANH T40	15,95	70	1113061011	1/2" 6KŞ LKM ANH 11	38,30	76
1107061308	1/4" DLK TORX UÇ LKM ANH TR8	18,55	70	1113061012	1/2" 6KŞ LKM ANH 12	38,30	76
1107061309	1/4" DLK TORX UÇ LKM ANH TR9	18,55	70	1113061013	1/2" 6KŞ LKM ANH 13	41,15	76
1107061310	1/4" DLK TORX UÇ LKM ANH TR10	18,55	70	1113061014	1/2" 6KŞ LKM ANH 14	41,15	76
1107061315	1/4" DLK TORX UÇ LKM ANH TR15	18,55	70	1113061015	1/2" 6KŞ LKM ANH 15	41,15	76
1107061320	1/4" DLK TORX UÇ LKM ANH TR20	18,55	70	1113061016	1/2" 6KŞ LKM ANH 16	43,10	76
1107061325	1/4" DLK TORX UÇ LKM ANH TR25	18,55	70	1113061017	1/2" 6KŞ LKM ANH 17	43,10	76
1107061327	1/4" DLK TORX UÇ LKM ANH TR27	18,55	70	1113061018	1/2" 6KŞ LKM ANH 18	43,10	76
1107061330	1/4" DLK TORX UÇ LKM ANH TR30	18,55	70	1113061019	1/2" 6KŞ LKM ANH 19	45,05	76
1107061340	1/4" DLK TORX UÇ LKM ANH TR40	21,75	70	1113061020	1/2" 6KŞ LKM ANH 20	45,05	76
1107061403	1/4" DÜZ UÇ LKM ANH 03	15,45	70	1113061021	1/2" 6KŞ LKM ANH 21	45,05	76
1107061435	1/4" DÜZ UÇ LKM ANH 3,5	15,45	70	1113061022	1/2" 6KŞ LKM ANH 22	45,05	76
1107061404	1/4" DÜZ UÇ LKM ANH 04	15,45	70	1113061023	1/2" 6KŞ LKM ANH 23	46,95	76
1107061445	1/4" DÜZ UÇ LKM ANH 4,5	15,45	70	1113061024	1/2" 6KŞ LKM ANH 24	46,95	76
1107061455	1/4" DÜZ UÇ LKM ANH 5,5	15,45	70	1113061025	1/2" 6KŞ LKM ANH 25	46,95	76
1107061465	1/4" DÜZ UÇ LKM ANH 6,5	15,45	70	1113061026	1/2" 6KŞ LKM ANH 26	46,95	76
1107061407	1/4" DÜZ UÇ LKM ANH 07	15,45	70	1113061027	1/2" 6KŞ LKM ANH 27	53,85	76
1107061408	1/4" DÜZ UÇ LKM ANH 08	20,20	70	1113061028	1/2" 6KŞ LKM ANH 28	53,85	76
1107061410	1/4" DÜZ UÇ LKM ANH 10	21,85	70	1113061029	1/2" 6KŞ LKM ANH 29	56,65	76
1107061501	1/4" YLD UÇ LKM ANH PH1	15,45	71	1113061030	1/2" 6KŞ LKM ANH 30	56,65	76
1107061502	1/4" YLD UÇ LKM ANH PH2	15,45	71	1113061032	1/2" 6KŞ LKM ANH 32	58,95	76
1107061503	1/4" YLD UÇ LKM ANH PH3	15,45	71	1114061010	1/2" 12KŞ LKM ANH 10	38,40	77
1107061504	1/4" YLD UÇ LKM ANH PH4	15,45	71	1114061011	1/2" 12KŞ LKM ANH 11	38,40	77
1107001042	1/4" BITS UÇ LKM ANH SET42	902,20	71	1114061012	1/2" 12KŞ LKM ANH 12	38,40	77
1507060050	1/4" ARA KOL 50	23,20	71	1114061013	1/2" 12KŞ LKM ANH 13	41,55	77
1507060100	1/4" ARA KOL 100	25,15	71	1114061014	1/2" 12KŞ LKM ANH 14	41,55	77
1507063150	1/4" ARA KOL FLEX 150	102,60	71	1114061015	1/2" 12KŞ LKM ANH 15	41,55	77
1507060038	1/4" MFSL	42,55	71	1114061016	1/2" 12KŞ LKM ANH 16	43,35	77

KOD	ÜRÜN	FİYAT	SAYFA
1114061017	1/2" 12KŞ LKM ANH 17	43,35	77
1114061018	1/2" 12KŞ LKM ANH 18	43,35	77
1114061019	1/2" 12KŞ LKM ANH 19	45,40	77
1114061020	1/2" 12KŞ LKM ANH 20	45,40	77
1114061021	1/2" 12KŞ LKM ANH 21	45,40	77
1114061022	1/2" 12KŞ LKM ANH 22	45,40	77
1114061023	1/2" 12KŞ LKM ANH 23	47,30	77
1114061024	1/2" 12KŞ LKM ANH 24	47,30	77
1114061026	1/2" 12KŞ LKM ANH 26	53,20	77
1114061027	1/2" 12KŞ LKM ANH 27	60,80	77
1114061028	1/2" 12KŞ LKM ANH 28	60,80	77
1114061030	1/2" 12KŞ LKM ANH 30	63,85	77
1114061032	1/2" 12KŞ LKM ANH 32	66,95	77
1413061008	1/2" 12KŞ LKM ANH 5/16 SAE	45,00	77
1413061095	1/2" 12KŞ LKM ANH 3/8 SAE	45,00	77
1413061010	1/2" 12KŞ LKM ANH 7/16 SAE	46,55	77
1413061011	1/2" 12KŞ LKM ANH 15/32 SAE	46,55	77
1413061012	1/2" 12KŞ LKM ANH 1/2 SAE	48,40	77
1413061013	1/2" 12KŞ LKM ANH 9/16 SAE	50,15	77
1413061014	1/2" 12KŞ LKM ANH 19/32 SAE	50,15	77
1413061015	1/2" 12KŞ LKM ANH 5/8 SAE	50,65	77
1413061016	1/2" 12KŞ LKM ANH 11/16 SAE	52,35	77
1413061017	1/2" 12KŞ LKM ANH 3/4 SAE	52,90	77
1413061020	1/2" 12KŞ LKM ANH 25/32 SAE	54,75	77
1413061021	1/2" 12KŞ LKM ANH 13/16 SAE	54,75	77
1413061022	1/2" 12KŞ LKM ANH 7/8 SAE	54,75	77
1413061024	1/2" 12KŞ LKM ANH 15/16 SAE	57,10	77
1413061025	1/2" 12KŞ LKM ANH 1 SAE	57,10	77
1413061027	1/2" 12KŞ LKM ANH 1-1/16 SAE	74,85	77
1413061029	1/2" 12KŞ LKM ANH 1-1/8 SAE	74,85	77
1413061030	1/2" 12KŞ LKM ANH 1-3/16 SAE	74,85	77
1413061032	1/2" 12KŞ LKM ANH 1-1/4 SAE	74,85	77
1113069160	1/2" BUJİ LKM LSTK 16	54,35	77
1113069208	1/2" BUJİ LKM LSTK 20,8	70,10	77
1108060010	1/2" 6KŞ DRN LKM ANH 10	71,85	78
1108060011	1/2" 6KŞ DRN LKM ANH 11	71,85	78
1108060012	1/2" 6KŞ DRN LKM ANH 12	71,85	78
1108060013	1/2" 6KŞ DRN LKM ANH 13	77,00	78
1108060014	1/2" 6KŞ DRN LKM ANH 14	77,00	78
1108060015	1/2" 6KŞ DRN LKM ANH 15	77,00	78
1108060016	1/2" 6KŞ DRN LKM ANH 16	80,65	78
1108060017	1/2" 6KŞ DRN LKM ANH 17	80,65	78
1108060018	1/2" 6KŞ DRN LKM ANH 18	80,65	78
1108060019	1/2" 6KŞ DRN LKM ANH 19	84,30	78
1108060010	1/2" 6KŞ DRN LKM TK10	772,80	78
1113060210	1/2" TORX LKM ANH E10	36,80	78
1113060212	1/2" TORX LKM ANH E12	36,80	78
1113060214	1/2" TORX LKM ANH E14	36,80	78
1113060216	1/2" TORX LKM ANH E16	36,80	78
1113060218	1/2" TORX LKM ANH E18	36,80	78
1113060220	1/2" TORX LKM ANH E20	41,45	78
1113006007	1/2" TORX LKM ANH SET7	304,65	78
1113061105	1/2" ALLEN UÇ LKM ANH 05 60	48,20	79
1113061106	1/2" ALLEN UÇ LKM ANH 06 60	48,20	79
1113061107	1/2" ALLEN UÇ LKM ANH 07 60	48,20	79
1113061108	1/2" ALLEN UÇ LKM ANH 08 60	48,20	79
1113061110	1/2" ALLEN UÇ LKM ANH 10 60	54,95	79
1113061112	1/2" ALLEN UÇ LKM ANH 12 60	54,95	79
1113061114	1/2" ALLEN UÇ LKM ANH 14 60	54,95	79
1113064105	1/2" ALLEN UÇ LKM ANH 05 100	56,90	79
1113064106	1/2" ALLEN UÇ LKM ANH 06 100	56,90	79
1113064107	1/2" ALLEN UÇ LKM ANH 07 100	56,90	79
1113064108	1/2" ALLEN UÇ LKM ANH 08 100	56,90	79
1113064110	1/2" ALLEN UÇ LKM ANH 10 100	65,85	79
1113064112	1/2" ALLEN UÇ LKM ANH 12 100	65,85	79
1113064114	1/2" ALLEN UÇ LKM ANH 14 100	79,35	79
1113064117	1/2" ALLEN UÇ LKM ANH 17 100	106,00	79

KOD	ÜRÜN	FİYAT	SAYFA
1113001107	1/2" ALLEN UÇ LKM ANH TK7	357,65	79
1113061220	1/2" TORX UÇ LKM ANH T20 60	59,40	79
1113061225	1/2" TORX UÇ LKM ANH T25 60	59,40	79
1113061227	1/2" TORX UÇ LKM ANH T27 60	59,40	79
1113061230	1/2" TORX UÇ LKM ANH T30 60	59,40	79
1113061240	1/2" TORX UÇ LKM ANH T40 60	59,40	79
1113061245	1/2" TORX UÇ LKM ANH T45 60	59,40	79
1113061250	1/2" TORX UÇ LKM ANH T50 60	59,40	79
1113061255	1/2" TORX UÇ LKM ANH T55 60	59,40	79
1113061260	1/2" TORX UÇ LKM ANH T60 60	63,20	79
1113064220	1/2" TORX UÇ LKM ANH T20 100	67,15	79
1113064225	1/2" TORX UÇ LKM ANH T25 100	67,15	79
1113064227	1/2" TORX UÇ LKM ANH T27 100	67,15	79
1113064230	1/2" TORX UÇ LKM ANH T30 100	67,15	79
1113064240	1/2" TORX UÇ LKM ANH T40 100	67,15	79
1113064245	1/2" TORX UÇ LKM ANH T45 100	67,15	79
1113064250	1/2" TORX UÇ LKM ANH T50 100	67,15	79
1113064255	1/2" TORX UÇ LKM ANH T55 100	67,15	79
1113064260	1/2" TORX UÇ LKM ANH T60 100	69,65	79
1113006009	1/2" TORX UÇ LKM ANH TK9	538,40	79
1113006017	1/2" ALLEN UÇ&TORX UÇ LKM ANH SET17	1.069,25	80
1114064005	1/2" 12KŞ LKM BİTS XZN M5 60	43,70	80
1114064006	1/2" 12KŞ LKM BİTS XZN M6 60	43,70	80
1114064008	1/2" 12KŞ LKM BİTS XZN M8 60	43,70	80
1114064010	1/2" 12KŞ LKM BİTS XZN M10 60	43,70	80
1114064012	1/2" 12KŞ LKM BİTS XZN M12 60	51,75	80
1114064106	1/2" 12KŞ LKM BİTS XZN M6 80	55,15	80
1114064108	1/2" 12KŞ LKM BİTS XZN M8 80	55,15	80
1114064110	1/2" 12KŞ LKM BİTS XZN M10 80	60,75	80
1114064112	1/2" 12KŞ LKM BİTS XZN M12 80	62,80	80
1114064114	1/2" 12KŞ LKM BİTS XZN M14 80	67,20	80
1114064208	1/2" 12KŞ LKM BİTS XZN M8 140	61,85	80
1114064210	1/2" 12KŞ LKM BİTS XZN M10 140	75,80	80
1114064212	1/2" 12KŞ LKM BİTS XZN M12 140	85,45	80
1114064214	1/2" 12KŞ LKM BİTS XZN M14 140	95,90	80
1114064216	1/2" 12KŞ LKM BİTS XZN M16 140	139,00	80
1114065004	1/2" LKM BİTS UÇ RİBE M4	60,10	80
1114065005	1/2" LKM BİTS UÇ RİBE M5	60,10	80
1114065006	1/2" LKM BİTS UÇ RİBE M6	60,10	80
1114065007	1/2" LKM BİTS UÇ RİBE M7	60,10	80
1114065008	1/2" LKM BİTS UÇ RİBE M8	60,10	80
1114065009	1/2" LKM BİTS UÇ RİBE M9	60,60	80
1114065010	1/2" LKM BİTS UÇ RİBE M10	60,60	80
1114065011	1/2" LKM BİTS UÇ RİBE M10,5	62,00	80
1114065012	1/2" LKM BİTS UÇ RİBE M12	77,15	80
1114065013	1/2" LKM BİTS UÇ RİBE M13	84,75	80
1114065014	1/2" LKM BİTS UÇ RİBE M14	84,75	80
1114065016	1/2" LKM BİTS UÇ RİBE M16	114,60	80
1513060032	1/2" CRC KOL 32DİŞ 250	313,35	81
1513064075	1/2" ARA KOL 75	70,85	81
1513064125	1/2" ARA KOL 125	79,20	81
1513064250	1/2" ARA KOL 250	120,60	81
1513065250	1/2" T KOL LKM ADP	73,95	81
1513062250	1/2" T KOL 250	173,20	81
1513064070	1/2" MFSL 70	100,65	81
1513060002	1/2"FX3/8" M LKM ADP	36,90	81
1513060003	1/2"FX3/4" M LKM ADP	58,05	81
1113065010	1/2" BİTS TUTC LKM	42,25	81
1113001038	1/4" & 1/2" 6KŞ LKM ANH SET35	1.703,30	82
1113002017	1/2" 6KŞ LKM ANH SET17	1.196,50	83
1114006024	1/2" 12KŞ LKM ANH SET24	1.594,05	83
1113002024	1/2" 6KŞ LKM ANH SET24	1.554,70	83
1413006024	1/2" 12KŞ LKM ANH SET24 SAE	1.753,30	83
1119061022	3/4" 6KŞ LKM ANH 22	95,55	85
1119061024	3/4" 6KŞ LKM ANH 24	95,55	85
1119061027	3/4" 6KŞ LKM ANH 27	98,70	85
1119061030	3/4" 6KŞ LKM ANH 30	106,40	85

KOD	ÜRÜN	FİYAT	SAYFA	KOD	ÜRÜN	FİYAT	SAYFA
1119061032	3/4" 6KŞ LKM ANH 32	110,65	85	1108067011	1/2" 6KŞ HVL DRN LKM ANH 11	81,75	88
1119061034	3/4" 6KŞ LKM ANH 34	146,00	85	1108067012	1/2" 6KŞ HVL DRN LKM ANH 12	81,75	88
1119061036	3/4" 6KŞ LKM ANH 36	146,00	85	1108067013	1/2" 6KŞ HVL DRN LKM ANH 13	88,75	88
1119061038	3/4" 6KŞ LKM ANH 38	146,00	85	1108067014	1/2" 6KŞ HVL DRN LKM ANH 14	88,75	88
1119061041	3/4" 6KŞ LKM ANH 41	214,60	85	1108067015	1/2" 6KŞ HVL DRN LKM ANH 15	99,10	88
1119061046	3/4" 6KŞ LKM ANH 46	228,50	85	1108067016	1/2" 6KŞ HVL DRN LKM ANH 16	99,10	88
1119061050	3/4" 6KŞ LKM ANH 50	274,40	85	1108067017	1/2" 6KŞ HVL DRN LKM ANH 17	99,10	88
1119061055	3/4" 6KŞ LKM ANH 55	349,40	85	1108067018	1/2" 6KŞ HVL DRN LKM ANH 18	99,10	88
1119061060	3/4" 6KŞ LKM ANH 60	417,25	85	1108067019	1/2" 6KŞ HVL DRN LKM ANH 19	99,10	88
1120061022	3/4" 12KŞ LKM ANH 22	101,00	85	1108067021	1/2" 6KŞ HVL DRN LKM ANH 21	103,35	88
1120061024	3/4" 12KŞ LKM ANH 24	101,00	85	1108067022	1/2" 6KŞ HVL DRN LKM ANH 22	103,35	88
1120061027	3/4" 12KŞ LKM ANH 27	104,15	85	1108067024	1/2" 6KŞ HVL DRN LKM ANH 24	109,25	88
1120061030	3/4" 12KŞ LKM ANH 30	112,20	85	1108067027	1/2" 6KŞ HVL DRN LKM ANH 27	144,55	88
1120061032	3/4" 12KŞ LKM ANH 32	117,40	85	1108067030	1/2" 6KŞ HVL DRN LKM ANH 30	161,90	88
1120061034	3/4" 12KŞ LKM ANH 34	154,45	85	1108067032	1/2" 6KŞ HVL DRN LKM ANH 32	172,65	88
1120061036	3/4" 12KŞ LKM ANH 36	154,45	85	1513067002	1/2"FX3/8"M HVL LKM ADP	108,00	88
1120061041	3/4" 12KŞ LKM ANH 41	227,95	85	1513067003	1/2"FX3/4"M HVL LKM ADP	123,25	88
1120061046	3/4" 12KŞ LKM ANH 46	242,35	85	1513067075	1/2" HVL LKM MFSL 75	207,25	88
1120061050	3/4" 12KŞ LKM ANH 50	290,05	85	1119067019	3/4" 6KŞ HVL LKM ANH 19	144,55	89
1419061022	3/4" 12KŞ LKM ANH 7/8 SAE	105,95	85	1119067021	3/4" 6KŞ HVL LKM ANH 21	144,55	89
1419061024	3/4" 12KŞ LKM ANH 15/16 SAE	105,95	85	1119067022	3/4" 6KŞ HVL LKM ANH 22	144,55	89
1419061025	3/4" 12KŞ LKM ANH 1 SAE	106,40	85	1119067024	3/4" 6KŞ HVL LKM ANH 24	144,55	89
1419061027	3/4" 12KŞ LKM ANH 1-1/16 SAE	109,15	85	1119067027	3/4" 6KŞ HVL LKM ANH 27	148,65	89
1419061028	3/4" 12KŞ LKM ANH 1-1/8 SAE	109,15	85	1119067030	3/4" 6KŞ HVL LKM ANH 30	160,20	89
1419061032	3/4" 12KŞ LKM ANH 1-1/4 SAE	122,50	85	1119067032	3/4" 6KŞ HVL LKM ANH 32	160,20	89
1419061033	3/4" 12KŞ LKM ANH 1-5/16 SAE	152,45	85	1119067034	3/4" 6KŞ HVL LKM ANH 34	208,85	89
1419061035	3/4" 12KŞ LKM ANH 1-3/8 SAE	152,45	85	1119067036	3/4" 6KŞ HVL LKM ANH 36	208,85	89
1419061036	3/4" 12KŞ LKM ANH 1-7/16 SAE	159,70	85	1119067041	3/4" 6KŞ HVL LKM ANH 41	322,25	89
1419061038	3/4" 12KŞ LKM ANH 1-1/2 SAE	159,70	85	1119067046	3/4" 6KŞ HVL LKM ANH 46	342,55	89
1419061041	3/4" 12KŞ LKM ANH 1-5/8 SAE	236,70	85	1519067175	3/4" HVL LKM ARA KOL 175	356,10	89
1419061044	3/4" 12KŞ LKM ANH 1-3/4 SAE	249,80	85	1519067250	3/4" HVL LKM ARA KOL 250	509,25	89
1419061046	3/4" 12KŞ LKM ANH 1-13/16 SAE	251,40	85	1519067330	3/4" HVL LKM ARA KOL 330	772,90	89
1419061047	3/4" 12KŞ LKM ANH 1-7/8 SAE	301,60	85	1519067108	3/4" HVL LKM MFSL 108	593,15	89
1419061050	3/4" 12KŞ LKM ANH 2 SAE	303,70	85	1519067011	3/4"FX1/2"M HVL LKM ADP	205,55	89
1519064510	3/4" CRC KOL 510	929,30	85	1125067024	1" 6KŞ HVL LKM ANH 24	260,25	90
1519064200	3/4" ARA KOL 200	245,00	85	1125067027	1" 6KŞ HVL LKM ANH 27	262,55	90
1519064400	3/4" ARA KOL 400	443,75	85	1125067030	1" 6KŞ HVL LKM ANH 30	264,75	90
1519064500	3/4" T KOL 500	493,85	86	1125067032	1" 6KŞ HVL LKM ANH 32	267,90	90
1519060008	3/4"FX1/2"M LKM ADP	97,65	86	1125067033	1" 6KŞ HVL LKM ANH 33	267,90	90
1519060001	3/4"FX1"M LKM ADP	132,00	86	1125067034	1" 6KŞ HVL LKM ANH 34	269,30	90
111906114	3/4" 6KŞ LKM ANH SET14	3.628,25	86	1125067036	1" 6KŞ HVL LKM ANH 36	270,60	90
112006014	3/4" 12KŞ LKM ANH SET14	3.716,90	86	1125067038	1" 6KŞ HVL LKM ANH 38	281,70	90
141906114	3/4" 12KŞ LKM ANH SET14 SAE	3.865,25	86	1125067041	1" 6KŞ HVL LKM ANH 41	343,35	90
1225060036	1" 12KŞ LKM ANH 36	299,20	87	1125067046	1" 6KŞ HVL LKM ANH 46	378,80	90
1225060041	1" 12KŞ LKM ANH 41	325,70	87	1125067050	1" 6KŞ HVL LKM ANH 50	404,00	90
1225060046	1" 12KŞ LKM ANH 46	394,90	87	1125067055	1" 6KŞ HVL LKM ANH 55	535,65	90
1225060050	1" 12KŞ LKM ANH 50	467,75	87	1125067060	1" 6KŞ HVL LKM ANH 60	669,45	90
1225060055	1" 12KŞ LKM ANH 55	599,00	87	1525067175	1" HVL LKM ARA KOL 175	649,55	90
1225060060	1" 12KŞ LKM ANH 60	778,60	87	1525067250	1" HVL LKM ARA KOL 250	834,65	90
1525060005	1"FX3/4"M LKM ADP	188,30	87	1525067330	1" HVL LKM ARA KOL 330	1.014,70	90
1113009003	1/2" 6KŞ JNT LKM ANH TK3	504,10	87	1525067128	1" HVL LKM MFSL 128	1.211,30	90
1113067010	1/2" 6KŞ HVL LKM ANH 10	42,85	88	1525067015	1"FX3/4"M HVL LKM ADP	248,50	90
1113067011	1/2" 6KŞ HVL LKM ANH 11	42,85	88	1800070607	2A KVN ANH 0607	44,30	91
1113067012	1/2" 6KŞ HVL LKM ANH 12	42,85	88	1800070809	2A KVN ANH 0809	48,65	91
1113067013	1/2" 6KŞ HVL LKM ANH 13	45,90	88	1800071011	2A KVN ANH 1011	66,75	91
1113067014	1/2" 6KŞ HVL LKM ANH 14	45,90	88	1800071213	2A KVN ANH 1213	70,75	91
1113067015	1/2" 6KŞ HVL LKM ANH 15	52,90	88	1800071415	2A KVN ANH 1415	77,55	91
1113067016	1/2" 6KŞ HVL LKM ANH 16	55,40	88	1800071617	2A KVN ANH 1617	83,30	91
1113067017	1/2" 6KŞ HVL LKM ANH 17	55,45	88	1800071819	2A KVN ANH 1819	86,35	91
1113067018	1/2" 6KŞ HVL LKM ANH 18	55,60	88	1800072022	2A KVN ANH 2022	95,10	91
1113067019	1/2" 6KŞ HVL LKM ANH 19	56,80	88	1800072224	2A KVN ANH 2224	106,80	91
1113067021	1/2" 6KŞ HVL LKM ANH 21	59,70	88	1800072427	2A KVN ANH 2427	138,10	91
1113067022	1/2" 6KŞ HVL LKM ANH 22	61,60	88	1800002108	2A KVN ANH SET10	617,00	91
1113067024	1/2" 6KŞ HVL LKM ANH 24	70,70	88	1841070021	1A KVN ANH&MİL 21 SET2	72,30	91
1113067027	1/2" 6KŞ HVL LKM ANH 27	89,95	88	1850075125	KVN ANH MİL 5X125	17,50	91
1513067125	1/2" HVL LKM ARA KOL 125	163,25	88	1850078180	KVN ANH MİL 8X180	26,75	91
1108067010	1/2" 6KŞ HVL DRN LKM ANH 10	81,75	88				

KOD	ÜRÜN	FİYAT	SAYFA	KOD	ÜRÜN	FİYAT	SAYFA
1850071120	KVN ANH MİL 10X120	30,35	91	3020123160	KRAFT KMB PNS 160	192,40	101
1850071200	KVN ANH MİL 10X200	34,15	91	3020123180	KRAFT KMB PNS 180	215,00	101
1870092427	AGR 2A BJN ANH UB 2427	184,80	91	3020123200	KRAFT KMB PNS 200	242,85	101
1870092730	AGR 2A BJN ANH UB 2730	212,35	91	3020125160	ERGO KMB PNS 160	197,55	101
1870092732	AGR 2A BJN ANH UB 2732	212,35	91	3020125180	ERGO KMB PNS 180	224,35	101
1870093032	AGR 2A BJN ANH UB 3032	219,75	91	3020125200	ERGO KMB PNS 200	253,25	101
1870093233	AGR 2A BJN ANH UB 3233	243,85	91	3020126160	1000V KMB PNS 160	216,25	101
1874092224	AGR 2A BJN ANH KB 2224	117,05	91	3020126180	1000V KMB PNS 180	231,50	101
1874092427	AGR 2A BJN ANH KB 2427	149,65	91	3020126200	1000V KMB PNS 200	261,35	101
1850091630	BJN ANH MİL 18X630	107,55	91	3030122180	AGR KMB PNS 180	268,50	101
1975091719	BJN ANH İSTV	220,90	92	3030122200	AGR KMB PNS 200	307,05	101
1975091322	1/2" ADP BJN ANH İSTV	224,90	92	3220132140	OPAK DÜZ UÇ KRGB 140	154,70	102
1940090017	BJN ANH PİPO TRNV UÇ 17	114,85	92	3220132160	OPAK DÜZ UÇ KRGB 160	174,85	102
1940090019	BJN ANH PİPO TRNV UÇ 19	121,30	92	3220132180	OPAK DÜZ UÇ KRGB 180	192,15	102
1940090021	BJN ANH PİPO TRNV UÇ 21	131,10	92	3220132200	OPAK DÜZ UÇ KRGB 200	203,80	102
1840080500	1/2" MFSL T KOL 500	469,15	92	3220133140	KRAFT DÜZ UÇ KRGB 140	191,00	102
1855080008	MFSL T KOL LKM 08	471,15	92	3220133160	KRAFT DÜZ UÇ KRGB 160	215,50	102
1855080010	MFSL T KOL LKM 10	592,45	92	3220133180	KRAFT DÜZ UÇ KRGB 180	237,15	102
1855080012	MFSL T KOL LKM 12	592,45	92	3220133200	KRAFT DÜZ UÇ KRGB 200	251,35	102
1855080013	MFSL T KOL LKM 13	592,45	92	3220135140	ERGO DÜZ UÇ KRGB 140	200,90	102
1855080017	MFSL T KOL LKM 17	659,90	92	3220135160	ERGO DÜZ UÇ KRGB 160	227,15	102
1855080019	MFSL T KOL LKM 19	838,75	92	3220135180	ERGO DÜZ UÇ KRGB 180	249,70	102
1610060100	3/8" TORK ANH 2,5-11NM	2.597,50	93	3220135200	ERGO DÜZ UÇ KRGB 200	264,55	102
1610060300	3/8" TORK ANH 7-33NM	2.685,35	93	3220136140	1000V DÜZ UÇ KRGB 140	221,25	102
1613061200	1/2" TORK ANH 25-135NM	2.773,25	93	3220136160	1000V DÜZ UÇ KRGB 160	244,65	102
1613062000	1/2" TORK ANH 50-225NM	2.862,50	93	3220136180	1000V DÜZ UÇ KRGB 180	274,60	102
1613063000	1/2" TORK ANH 70-330NM	3.483,15	93	3220136200	1000V DÜZ UÇ KRGB 200	285,15	102
1619062080	3/4" TORK ANH 200-800NM	10.733,65	93	3225132160	OPAK EĞRİ UÇ KRGB 160	184,75	103
1607060420	1/4" CRC TORK ANH 4-20NM	2.056,10	93	3225132180	OPAK EĞRİ UÇ KRGB 180	208,75	103
1610062010	3/8" CRC TORK ANH 20-100NM	2.321,45	93	3225132200	OPAK EĞRİ UÇ KRGB 200	223,05	103
1613064020	1/2" CRC TORK ANH 40-200NM	2.719,20	93	3020002003	OPAK PNS 160 SET3	528,55	103
1613066034	1/2" CRC TORK ANH 60-340NM	2.850,85	93	3225133160	KRAFT EĞRİ UÇ KRGB 160	222,15	103
1619061060	3/4" CRC TORK ANH 100-600NM	7.539,85	93	3225133180	KRAFT EĞRİ UÇ KRGB 180	243,95	103
2100100008	STILSON BORU ANH 8"	289,85	97	3225133200	KRAFT EĞRİ UÇ KRGB 200	268,35	103
2100100010	STILSON BORU ANH 10"	348,55	97	3020001002	PNS&KNT KLM SET2	198,55	103
2100100012	STILSON BORU ANH 12"	392,15	97	3700162140	OPAK YNKS 140	163,45	104
2100100014	STILSON BORU ANH 14"	481,35	97	3700162160	OPAK YNKS 160	196,70	104
2100100018	STILSON BORU ANH 18"	611,10	97	3700162180	OPAK YNKS 180	229,50	104
2100100024	STILSON BORU ANH 24"	984,60	97	3700163140	KRAFT YNKS 140	197,05	104
2110100008	AGR BORU ANH 8"	384,85	97	3700163160	KRAFT YNKS 160	236,75	104
2110100010	AGR BORU ANH 10"	477,70	97	3700163180	KRAFT YNKS 180	275,85	104
2110100012	AGR BORU ANH 12"	547,15	97	3700165140	ERGO YNKS 140	212,55	104
2110100014	AGR BORU ANH 14"	636,95	97	3700165160	ERGO YNKS 160	245,75	104
2110100018	AGR BORU ANH 18"	888,65	97	3700165180	ERGO YNKS 180	286,60	104
2110100024	AGR BORU ANH 24"	1.433,05	97	3700166140	1000V YNKS 140	248,00	104
2110100036	AGR BORU ANH 36"	3.174,25	97	3700166160	1000V YNKS 160	281,50	104
2110100048	AGR BORU ANH 48"	6.501,30	97	3700166180	1000V YNKS 180	314,95	104
2201100010	1" MŞL BORU ANH 85	295,10	97	3705165160	YNKS İNCE UÇ 160	255,95	106
2201100015	1-1/2" MŞL BORU ANH 85	456,95	97	3730162160	AGR YNKS 160	279,05	106
2201100020	2" MŞL BORU ANH 85	684,20	97	3730162200	AGR YNKS 200	362,70	106
2201100030	3" MŞL BORU ANH 85	1.037,25	97	3335001004	SGM PNS SET4	783,60	106
2201100040	4" MŞL BORU ANH 85	1.555,75	97	3301120140	DÜZ UÇ DIŞ SGM PNS YAY 140	184,60	107
2400110160	ÜNV FORT PNS 160	180,70	98	3301120180	DÜZ UÇ DIŞ SGM PNS YAY 180	194,60	107
2400110240	ÜNV FORT PNS 240	252,65	98	3301120225	DÜZ UÇ DIŞ SGM PNS YAY 225	243,20	107
2400110315	ÜNV FORT PNS 315	413,85	98	3301120295	DÜZ UÇ DIŞ SGM PNS YAY 295	412,50	107
2400116240	1000V ÜNV FORT PNS 240	293,15	99	3311120125	EĞRİ UÇ DIŞ SGM PNS YAY 125	206,30	107
2415110240	FORT PNS YAY 240	340,90	99	3311120170	EĞRİ UÇ DIŞ SGM PNS YAY 170	217,30	107
2500110250	ÜNV AYR PNS 250	300,95	99	3311120210	EĞRİ UÇ DIŞ SGM PNS YAY 210	249,70	107
2505110250	STD AYR PNS 250	300,95	99	3311120275	EĞRİ UÇ DIŞ SGM PNS YAY 275	433,10	107
2510110250	SPCL AYR PNS 250	300,95	99	3321120140	DÜZ UÇ İÇ SGM PNS YAYZ 140	169,95	107
2511110280	CTIP AYR PNS 280	503,20	99	3321120180	DÜZ UÇ İÇ SGM PNS YAYZ 180	179,35	107
2512110200	KYNK AYR PNS DÜZ AĞZ 200	507,85	100	3321120225	DÜZ UÇ İÇ SGM PNS YAYZ 225	223,25	107
2513110280	KYNK AYR PNS BORU AĞZ 280	507,85	100	3321120310	DÜZ UÇ İÇ SGM PNS YAYZ 310	383,05	107
2515110270	KPRT AYR PNS 270	403,10	100	3331120130	EĞRİ UÇ İÇ SGM PNS YAYZ 130	182,75	107
3020122160	OPAK KMB PNS 160	157,00	101	3331120170	EĞRİ UÇ İÇ SGM PNS YAYZ 170	192,35	107
3020122180	OPAK KMB PNS 180	178,20	101	3331120210	EĞRİ UÇ İÇ SGM PNS YAYZ 210	240,10	107
3020122200	OPAK KMB PNS 200	201,15	101	3331120290	EĞRİ UÇ İÇ SGM PNS YAYZ 290	412,10	107

KOD	ÜRÜN	FİYAT	SAYFA	KOD	ÜRÜN	FİYAT	SAYFA
3420120220	HRTM KLPÇ PNS 220	328,15	108	4120186200	KRAFT YLD UÇ TRNV 6X200	83,60	129
3425120220	SKŞTTİP HRTM KLPÇ PNS 235	336,30	108	4120188150	KRAFT YLD UÇ TRNV 8X150	101,95	129
3852240225	DLK ZMB 225	229,55	108	4120181200	KRAFT YLD UÇ TRNV 10X200	157,75	129
3715160165	1A KBLO KSC	210,85	109	4120185300	KRAFT YLD UÇ TRNV 4,5X300	140,80	129
3715166165	1000V 1A KBLO KSC	248,70	109	4120186300	KRAFT YLD UÇ TRNV 6X300	145,60	129
3720160220	2A KBLO KSC	282,70	110	4120008106	KRAFT YLD UÇ TRNV TK6	302,85	129
3860260180	TSTR ÇPRZ	260,90	110	4100008107	KRAFT DÜZ&YLD UÇ TRNV SET7	299,40	129
3550140125	ELKTRO YNKS 125	224,10	111	4110175525	KRAFT TPÇ DÜZ UÇ TRNV 5,5X25	31,80	130
3551140125	ELKTRO TPKSK 125	209,15	111	4110175540	KRAFT TPÇ DÜZ UÇ TRNV 5,5X40	43,00	130
3552140125	ELKTRO YVRL UÇ KRGB 125	202,85	111	4110176525	KRAFT TPÇ DÜZ UÇ TRNV 6,5X25	35,40	130
3553140150	ELKTRO DÜZ UÇ KRGB 150	202,25	111	4110176540	KRAFT TPÇ DÜZ UÇ TRNV 6,5X40	48,70	130
3554140150	ELKTRO KRGB UB 150	202,25	111	4130184525	KRAFT TPÇ YLD UÇ TRNV 4,5X25	33,80	130
3555140150	ELKTRO SVR UÇ DÜZ KRGB 150	202,25	111	4130184540	KRAFT TPÇ YLD UÇ TRNV 4,5X40	42,80	130
3556140150	ELKTRO SVR UÇ EĞRİ KRGB 150	202,25	112	4130180625	KRAFT TPÇ YLD UÇ TRNV 6X25	35,50	130
3557140125	ELKTRO PNS 125	202,85	112	4130180640	KRAFT TPÇ YLD UÇ TRNV 6X40	48,10	130
356002104	ELKTRO KSK&PNS SET4	838,35	112	4140172575	1000V DÜZ UÇ TRNV 2,5X75	35,40	131
356502104	ELKTRO KRGB SET4	809,60	112	4140174100	1000V DÜZ UÇ TRNV 4X100	41,55	131
3800150160	KRPTN 160	161,60	113	4140175512	1000V DÜZ UÇ TRNV 5,5X125	54,75	131
3800150180	KRPTN 180	167,20	113	4140176515	1000V DÜZ UÇ TRNV 6,5X150	61,20	131
3800150200	KRPTN 200	222,95	113	4140009106	1000V DÜZ&YLD UÇ TRNV SET6	306,10	131
3800150250	KRPTN 250	242,90	113	4145180360	1000V YLD UÇ TRNV 3X60	36,80	131
3830150225	BTN KRPTN 225	200,60	113	4145184580	1000V YLD UÇ TRNV 4,5X80	52,00	131
3830150250	BTN KRPTN 250	221,65	113	4145186100	1000V YLD UÇ TRNV 6X100	61,20	131
3830150280	BTN KRPTN 280	264,55	113	4300170380	OPAK DÜZ UÇ TRNV 3X80	25,70	132
3831150280	BTN KRPTN YAY 280	265,55	113	4300170480	OPAK DÜZ UÇ TRNV 4X80	26,60	132
3835150280	AGR BTN KRPTN 280	263,20	113	4300174100	OPAK DÜZ UÇ TRNV 4X100	31,80	132
3850120200	DNLY 200	326,75	113	4300175100	OPAK DÜZ UÇ TRNV 5X100	38,35	132
3020006003	1000V ELKT 160 SET3	742,40	120	4300175125	OPAK DÜZ UÇ TRNV 5X125	44,60	132
8795006005	1000V ELKT SET5	914,10	122	4300176100	OPAK DÜZ UÇ TRNV 6X100	39,95	132
8440001023	TKÇ PLS ELKT SET23 19"	2.113,85	122	4300176125	OPAK DÜZ UÇ TRNV 6X125	45,50	132
4550170135	KNT KLM DÜZ UÇ 135	32,95	127	4300176150	OPAK DÜZ UÇ TRNV 6X150	49,80	132
4550170190	KNT KLM DÜZ UÇ 190	41,55	127	4300177125	OPAK DÜZ UÇ TRNV 7X125	51,00	132
4555170165	MSTR KNT KLM DÜZ UÇ 165	45,45	127	4300177150	OPAK DÜZ UÇ TRNV 7X150	58,60	132
4560180135	KNT KLM YLD UÇ 135	36,00	127	4300178175	OPAK DÜZ UÇ TRNV 8X175	71,15	132
4560180190	KNT KLM YLD UÇ 190	49,90	127	4300179200	OPAK DÜZ UÇ TRNV 9X200	93,90	132
4565170135	OTO KNT KLM 135	88,75	127	4320180360	OPAK YLD UÇ TRNV 3X60	28,35	132
4100170340	KRAFT DÜZ UÇ TRNV 3X40	27,50	128	4320184580	OPAK YLD UÇ TRNV 4,5X80	40,50	132
4100170380	KRAFT DÜZ UÇ TRNV 3X80	29,25	128	4320186100	OPAK YLD UÇ TRNV 6X100	49,05	132
4100170480	KRAFT DÜZ UÇ TRNV 4X80	31,60	128	4320188150	OPAK YLD UÇ TRNV 8X150	92,95	132
4100174100	KRAFT DÜZ UÇ TRNV 4X100	36,60	128	4300008107	OPAK DÜZ&YLD UÇ TRNV SET7	268,05	132
4100170580	KRAFT DÜZ UÇ TRNV 5X80	38,70	128	4325180360	OPAK PZ UÇ TRNV 3X60	30,95	132
4100175100	KRAFT DÜZ UÇ TRNV 5X100	42,65	128	4325184580	OPAK PZ UÇ TRNV 4,5X80	44,60	132
4100175125	KRAFT DÜZ UÇ TRNV 5X125	48,70	128	4325186100	OPAK PZ UÇ TRNV 6X100	53,70	132
4100175150	KRAFT DÜZ UÇ TRNV 5X150	53,15	128	4325188150	OPAK PZ UÇ TRNV 8X150	101,95	132
4100176100	KRAFT DÜZ UÇ TRNV 6X100	43,70	128	4350170380	ERGO DÜZ UÇ TRNV 3X80	31,80	133
4100176125	KRAFT DÜZ UÇ TRNV 6X125	50,05	128	4350170480	ERGO DÜZ UÇ TRNV 4X80	33,35	133
4100176150	KRAFT DÜZ UÇ TRNV 6X150	54,95	128	4350174100	ERGO DÜZ UÇ TRNV 4X100	38,00	133
4100176175	KRAFT DÜZ UÇ TRNV 6X175	70,55	128	4350175100	ERGO DÜZ UÇ TRNV 5X100	43,70	133
4100177125	KRAFT DÜZ UÇ TRNV 7X125	55,75	128	4350175125	ERGO DÜZ UÇ TRNV 5X125	50,45	133
4100177150	KRAFT DÜZ UÇ TRNV 7X150	64,35	128	4350176100	ERGO DÜZ UÇ TRNV 6X100	45,25	133
4100177175	KRAFT DÜZ UÇ TRNV 7X175	73,85	128	4350176125	ERGO DÜZ UÇ TRNV 6X125	51,85	133
4100178150	KRAFT DÜZ UÇ TRNV 8X150	73,20	128	4350176150	ERGO DÜZ UÇ TRNV 6X150	56,85	133
4100178175	KRAFT DÜZ UÇ TRNV 8X175	78,00	128	4350177125	ERGO DÜZ UÇ TRNV 7X125	57,95	133
4100178200	KRAFT DÜZ UÇ TRNV 8X200	95,50	128	4350177150	ERGO DÜZ UÇ TRNV 7X150	66,60	133
4100179200	KRAFT DÜZ UÇ TRNV 9X200	101,85	128	4350178175	ERGO DÜZ UÇ TRNV 8X175	80,75	133
4100171125	KRAFT DÜZ UÇ TRNV 11X250	129,45	128	4350179200	ERGO DÜZ UÇ TRNV 9X200	103,00	133
4100008108	KRAFT DÜZ UÇ TRNV TK8	337,50	128	4370180360	ERGO YLD UÇ TRNV 3X60	32,35	133
4100174300	KRAFT DÜZ UÇ TRNV 4X300	90,10	128	4370184580	ERGO YLD UÇ TRNV 4,5X80	46,15	133
4100175250	KRAFT DÜZ UÇ TRNV 5X250	100,70	128	4370186100	ERGO YLD UÇ TRNV 6X100	56,00	133
4100175350	KRAFT DÜZ UÇ TRNV 5X350	113,75	128	4370188150	ERGO YLD UÇ TRNV 8X150	105,45	133
4100176350	KRAFT DÜZ UÇ TRNV 6X350	120,45	128	4350008107	ERGO DÜZ&YLD UÇ TRNV SET7	312,60	133
4120180360	KRAFT YLD UÇ TRNV 3X60	30,95	129	4240170680	DĞŞK UÇ TRNV 6X80	56,20	134
4120184580	KRAFT YLD UÇ TRNV 4,5X80	44,60	129	4500172560	KLMNS DÜZ UÇ TRNV 2,5X60	25,00	134
4120185100	KRAFT YLD UÇ TRNV 4,5X100	49,75	129	4500172580	KLMNS DÜZ UÇ TRNV 2,5X80	26,15	134
4120185150	KRAFT YLD UÇ TRNV 4,5X150	59,50	129	4500170380	KLMNS DÜZ UÇ TRNV 3X80	27,70	134
4120186100	KRAFT YLD UÇ TRNV 6X100	53,70	129	4500173100	KLMNS DÜZ UÇ TRNV 3X100	33,80	134
4120186150	KRAFT YLD UÇ TRNV 6X150	64,35	129	4500173125	KLMNS DÜZ UÇ TRNV 3X125	44,60	134

KOD	ÜRÜN	FİYAT	SAYFA
4500173510	KLMNS DÜZ UÇ TRNV 3,5X100	34,95	134
4500170480	KLMNS DÜZ UÇ TRNV 4X80	28,45	134
4500174100	KLMNS DÜZ UÇ TRNV 4X100	34,95	134
4500174125	KLMNS DÜZ UÇ TRNV 4X125	46,90	134
4500174150	KLMNS DÜZ UÇ TRNV 4X150	51,10	134
4520180360	KLMNS YLD UÇ TRNV 3X60	29,25	134
4520180480	KLMNS YLD UÇ TRNV 4X80	42,00	134
4520184150	KLMNS YLD UÇ TRNV 4X150	56,10	134
4240007102	DĞŞK UÇ TRNV TK2	96,50	134
4500008106	KLMNS DÜZ&YLD UÇ TRNV SET6	228,45	134
4530170560	KLMNS TORX UÇ TRNV T5	33,80	135
4530170660	KLMNS TORX UÇ TRNV T6	33,80	135
4530170760	KLMNS TORX UÇ TRNV T7	35,00	135
4530170860	KLMNS TORX UÇ TRNV T8	35,00	135
4530170960	KLMNS TORX UÇ TRNV T9	35,00	135
4530171060	KLMNS TORX UÇ TRNV T10	35,00	135
4530001006	KLMNS TORX UÇ TRNV TK6	207,60	135
4540190190	KLIPS SÖKM TRNV	132,20	135
4765190040	TTİP LKM UÇ TRNV 04	71,45	136
4765190050	TTİP LKM UÇ TRNV 05	71,45	136
4765190055	TTİP LKM UÇ TRNV 5,5	71,45	136
4765190060	TTİP LKM UÇ TRNV 06	71,45	136
4765190070	TTİP LKM UÇ TRNV 07	76,20	136
4765190080	TTİP LKM UÇ TRNV 08	76,20	136
4765190090	TTİP LKM UÇ TRNV 09	84,45	136
4765190100	TTİP LKM UÇ TRNV 10	84,45	136
4765190110	TTİP LKM UÇ TRNV 11	93,45	136
4765190120	TTİP LKM UÇ TRNV 12	96,50	136
4765190130	TTİP LKM UÇ TRNV 13	100,90	136
4765190140	TTİP LKM UÇ TRNV 14	117,35	136
4770190040	LKM UÇ TRNV 04	81,25	136
4770190050	LKM UÇ TRNV 05	81,25	136
4770190055	LKM UÇ TRNV 5,5	81,25	136
4770190060	LKM UÇ TRNV 06	81,25	136
4770190070	LKM UÇ TRNV 07	87,25	136
4770190080	LKM UÇ TRNV 08	87,25	136
4770190090	LKM UÇ TRNV 09	94,15	136
4770190100	LKM UÇ TRNV 10	94,15	136
4770190110	LKM UÇ TRNV 11	102,80	136
4770190120	LKM UÇ TRNV 12	110,30	136
4770190130	LKM UÇ TRNV 13	118,75	136
4770190140	LKM UÇ TRNV 14	131,35	136
4770008108	LKM UÇ TRNV TK8	775,90	136
4773190040	1000V LKM UÇ TRNV 04	115,25	137
4773190050	1000V LKM UÇ TRNV 05	115,25	137
4773190055	1000V LKM UÇ TRNV 5,5	115,25	137
4773190060	1000V LKM UÇ TRNV 06	115,25	137
4773190070	1000V LKM UÇ TRNV 07	123,55	137
4773190080	1000V LKM UÇ TRNV 08	123,55	137
4773190090	1000V LKM UÇ TRNV 09	133,45	137
4773190100	1000V LKM UÇ TRNV 10	133,45	137
4773190110	1000V LKM UÇ TRNV 11	145,70	137
4773190120	1000V LKM UÇ TRNV 12	156,30	137
4773190130	1000V LKM UÇ TRNV 13	168,40	137
4773190140	1000V LKM UÇ TRNV 14	186,20	137
4773008108	1000V LKM UÇ TRNV TK8	1.099,65	137
4775180010	TORX UÇ TRNV T10	40,25	137
4775180015	TORX UÇ TRNV T15	40,25	137
4775180020	TORX UÇ TRNV T20	44,65	137
4775180025	TORX UÇ TRNV T25	51,75	137
4775180027	TORX UÇ TRNV T27	57,15	137
4775180030	TORX UÇ TRNV T30	60,65	137
4775180040	TORX UÇ TRNV T40	75,35	137
4775180045	TORX UÇ TRNV T45	85,15	137
4775008107	TORX UÇ TRNV TK7	370,05	137
4776180009	DLK TORX UÇ TRNV TR9	52,35	138
4776180010	DLK TORX UÇ TRNV TR10	54,10	138

KOD	ÜRÜN	FİYAT	SAYFA
4776180015	DLK TORX UÇ TRNV TR15	54,10	138
4776180020	DLK TORX UÇ TRNV TR20	60,40	138
4776180025	DLK TORX UÇ TRNV TR25	69,65	138
4776180027	DLK TORX UÇ TRNV TR27	76,85	138
4776180030	DLK TORX UÇ TRNV TR30	81,65	138
4776180040	DLK TORX UÇ TRNV TR40	101,25	138
4776008107	DLK TORX UÇ TRNV TK7	498,00	138
4780196120	MNY BİTS TUTC TRNV 6,3X120	104,85	138
4783196120	1000V MNY BİTS TUTC TRNV 6,3X120	129,55	138
4785196330	MNY BİTS TUTC TRNV 6,3X30	57,05	138
4790266360	ÜNV MNY BİTS ADP 6,3X60	50,00	138
4795190010	TTİP MNY BİTS TUTC TRNV 6,3X130	110,85	139
4788196160	MNY BİTS TUTC TRNV FLEX SNG 6,3X160	217,35	139
4805205010	1/4"M-1/4"M BİTS UÇ LKM ADP	17,95	139
4805205011	1/4"M-1/2"M BİTS UÇ LKM ADP	36,50	139
4815006107	DĞŞK BİTS UÇ TRNV SET7	120,60	139
4800008106	BİTS UÇ SET6 (25)	40,65	139
4800008110	BİTS UÇ SET10 (25)	75,30	139
4800008131	BİTS UÇ PLS KUTU SET31	253,25	139
4810200645	DÜZ BİTS UÇ 0,6X4,5 (25)	5,85	140
4810200855	DÜZ BİTS UÇ 0,8X5,5 (25)	5,85	140
4810201265	DÜZ BİTS UÇ 1,2X6,5 (25)	5,85	140
4810205645	DÜZ BİTS UÇ 0,6X4,5 (50)	9,85	140
4810205855	DÜZ BİTS UÇ 0,8X5,5 (50)	9,85	140
4810205265	DÜZ BİTS UÇ 1,2X6,5 (50)	9,85	140
4860200745	DÜZ BİTS UÇ 4,5 (75)	15,00	140
4860200755	DÜZ BİTS UÇ 5,5 (75)	15,00	140
4860200765	DÜZ BİTS UÇ 6,5 (75)	15,00	140
4860201045	DÜZ BİTS UÇ 4,5 (100)	22,40	140
4860201055	DÜZ BİTS UÇ 5,5 (100)	22,40	140
4860201065	DÜZ BİTS UÇ 6,5 (100)	22,40	140
4860201545	DÜZ BİTS UÇ 4,5 (150)	32,10	140
4860201555	DÜZ BİTS UÇ 5,5 (150)	32,10	140
4860201565	DÜZ BİTS UÇ 6,5 (150)	32,10	140
4810000645	DÜZ BİTS UÇ TK10 0,6X4,5	58,50	140
4810000855	DÜZ BİTS UÇ TK10 0,8X5,5	58,50	140
4810001265	DÜZ BİTS UÇ TK10 1,2X6,5	58,50	140
4820210001	YLD BİTS UÇ PH1 (25)	6,45	140
4820210002	YLD BİTS UÇ PH2 (25)	6,45	140
4820210003	YLD BİTS UÇ PH3 (25)	6,45	140
4820210011	YLD BİTS UÇ PH1 (50)	11,45	140
4820210012	YLD BİTS UÇ PH2 (50)	11,45	140
4820210013	YLD BİTS UÇ PH3 (50)	11,45	140
4870210701	YLD BİTS UÇ PH1 (75)	15,55	140
4870210702	YLD BİTS UÇ PH2 (75)	15,55	140
4870210703	YLD BİTS UÇ PH3 (75)	15,55	140
4870211001	YLD BİTS UÇ PH1 (100)	23,80	140
4870211002	YLD BİTS UÇ PH2 (100)	23,80	140
4870211003	YLD BİTS UÇ PH3 (100)	23,80	140
4870211501	YLD BİTS UÇ PH1 (150)	33,70	140
4870211502	YLD BİTS UÇ PH2 (150)	33,70	140
4870211503	YLD BİTS UÇ PH3 (150)	33,70	140
4820000001	YLD BİTS UÇ TK10 PH1 (25)	64,50	140
4820000002	YLD BİTS UÇ TK10 PH2 (25)	64,50	140
4820000003	YLD BİTS UÇ TK10 PH3 (25)	64,50	140
4825210001	PZ1 BİTS UÇ (25)	6,95	141
4825210002	PZ2 BİTS UÇ (25)	6,95	141
4825210003	PZ3 BİTS UÇ (25)	6,95	141
4825210011	PZ1 BİTS UÇ (50)	12,10	141
4825210012	PZ2 BİTS UÇ (50)	12,10	141
4825210013	PZ3 BİTS UÇ (50)	12,10	141
4880210701	PZ1 BİTS UÇ (75)	15,80	141
4880210702	PZ2 BİTS UÇ (75)	15,80	141
4880210703	PZ3 BİTS UÇ (75)	15,80	141
4880211001	PZ1 BİTS UÇ (100)	24,00	141
4880211002	PZ2 BİTS UÇ (100)	24,00	141
4880211003	PZ3 BİTS UÇ (100)	24,00	141

KOD	ÜRÜN	FİYAT	SAYFA	KOD	ÜRÜN	FİYAT	SAYFA
4880211501	PZ1 BİTS UÇ (150)	34,45	141	4901221587	6KŞ ALLEN ANH 5/8 SAE	119,10	143
4880211502	PZ2 BİTS UÇ (150)	34,45	141	4901221905	6KŞ ALLEN ANH 3/4 SAE	166,65	143
4880211503	PZ3 BİTS UÇ (150)	34,45	141	4901003110	6KŞ ALLEN ANH TK10 SAE	172,50	143
4825000001	PZ1 BİTS UÇ TK10 (25)	69,50	141	4901003112	6KŞ ALLEN ANH TK12 SAE	301,65	143
4825000002	PZ2 BİTS UÇ TK10 (25)	69,50	141	4903220020	6KŞ ALLEN ANH UB 02	7,30	144
4825000003	PZ3 BİTS UÇ TK10 (25)	69,50	141	4903220025	6KŞ ALLEN ANH UB 2,5	8,55	144
4830210025	TORX BİTS UÇ T25 (25)	9,60	141	4903220030	6KŞ ALLEN ANH UB 03	9,75	144
4830210027	TORX BİTS UÇ T27 (25)	9,60	141	4903220035	6KŞ ALLEN ANH UB 3,5	11,95	144
4830210030	TORX BİTS UÇ T30 (25)	9,60	141	4903220040	6KŞ ALLEN ANH UB 04	12,25	144
4830210040	TORX BİTS UÇ T40 (25)	9,60	141	4903220050	6KŞ ALLEN ANH UB 05	13,80	144
4830210125	TORX BİTS UÇ T25 (50)	12,10	141	4903220060	6KŞ ALLEN ANH UB 06	22,40	144
4830210127	TORX BİTS UÇ T27 (50)	12,10	141	4903220070	6KŞ ALLEN ANH UB 07	33,30	144
4830210130	TORX BİTS UÇ T30 (50)	12,10	141	4903220080	6KŞ ALLEN ANH UB 08	36,25	144
4830210140	TORX BİTS UÇ T40 (50)	12,10	141	4903220090	6KŞ ALLEN ANH UB 09	49,20	144
4885210725	TORX BİTS UÇ T25 (75)	16,90	141	4903220100	6KŞ ALLEN ANH UB 10	61,00	144
4885210727	TORX BİTS UÇ T27 (75)	16,90	141	4903220120	6KŞ ALLEN ANH UB 12	87,75	144
4885210730	TORX BİTS UÇ T30 (75)	16,90	141	4903220140	6KŞ ALLEN ANH UB 14	141,30	144
4885210740	TORX BİTS UÇ T40 (75)	16,90	141	4903220160	6KŞ ALLEN ANH UB 16	228,65	144
4885211025	TORX BİTS UÇ T25 (100)	24,45	141	4903220170	6KŞ ALLEN ANH UB 17	249,00	144
4885211027	TORX BİTS UÇ T27 (100)	24,45	141	4903220190	6KŞ ALLEN ANH UB 19	369,00	144
4885211030	TORX BİTS UÇ T30 (100)	24,45	141	4903003110	6KŞ ALLEN ANH UB TK10	253,80	144
4885211040	TORX BİTS UÇ T40 (100)	24,45	141	4903003112	6KŞ ALLEN ANH UB TK12	353,50	144
4885211525	TORX BİTS UÇ T25 (150)	35,00	141	4905220020	6KŞ YVRL BAŞL ALLEN ANH KB 02	8,20	144
4885211527	TORX BİTS UÇ T27 (150)	35,00	141	4905220025	6KŞ YVRL BAŞL ALLEN ANH KB 2,5	9,85	144
4885211530	TORX BİTS UÇ T30 (150)	35,00	141	4905220030	6KŞ YVRL BAŞL ALLEN ANH KB 03	11,25	144
4885211540	TORX BİTS UÇ T40 (150)	35,00	141	4905220040	6KŞ YVRL BAŞL ALLEN ANH KB 04	13,95	144
4830000025	TORX BİTS UÇ T25 TK10 (25)	96,00	141	4905220050	6KŞ YVRL BAŞL ALLEN ANH KB 05	14,65	144
4830000027	TORX BİTS UÇ T27 TK10 (25)	96,00	141	4905220060	6KŞ YVRL BAŞL ALLEN ANH KB 06	23,70	144
4830000030	TORX BİTS UÇ T30 TK10 (25)	96,00	141	4905220080	6KŞ YVRL BAŞL ALLEN ANH KB 08	36,45	144
4830000040	TORX BİTS UÇ T40 TK10 (25)	96,00	141	4905220100	6KŞ YVRL BAŞL ALLEN ANH KB 10	57,95	144
4784196346	1/4" BİTS TUTUC TRNV AVUÇ İÇİ	202,05	142	4905007108	6KŞ YVRL BAŞL ALLEN ANH KB TK8	176,00	144
4850000713	BİTS UÇ SET13 (75)	206,65	142	4906220015	6KŞ YVRL BAŞL ALLEN ANH UB 1,5	10,85	145
4850001013	BİTS UÇ SET13 (100)	308,40	142	4906220020	6KŞ YVRL BAŞL ALLEN ANH UB 02	14,55	145
4850001513	BİTS UÇ SET13 (150)	440,75	142	4906220025	6KŞ YVRL BAŞL ALLEN ANH UB 2,5	15,75	145
4900220015	6KŞ ALLEN ANH 1,5	3,45	143	4906220030	6KŞ YVRL BAŞL ALLEN ANH UB 03	17,10	145
4900220020	6KŞ ALLEN ANH KB 02	5,05	143	4906220040	6KŞ YVRL BAŞL ALLEN ANH UB 04	19,45	145
4900220025	6KŞ ALLEN ANH KB 2,5	6,15	143	4906220050	6KŞ YVRL BAŞL ALLEN ANH UB 05	24,50	145
4900220030	6KŞ ALLEN ANH KB 03	6,80	143	4906220060	6KŞ YVRL BAŞL ALLEN ANH UB 06	28,15	145
4900220035	6KŞ ALLEN ANH KB 3,5	8,40	143	4906220080	6KŞ YVRL BAŞL ALLEN ANH UB 08	44,85	145
4900220040	6KŞ ALLEN ANH KB 04	8,60	143	4906220100	6KŞ YVRL BAŞL ALLEN ANH UB 10	66,75	145
4900220050	6KŞ ALLEN ANH KB 05	10,00	143	4906003109	6KŞ YVRL BAŞL ALLEN ANH UB TK9	241,95	145
4900220060	6KŞ ALLEN ANH KB 06	13,20	143	4910220006	TORX ALLEN ANH T6	34,40	145
4900220070	6KŞ ALLEN ANH KB 07	19,50	143	4910220007	TORX ALLEN ANH T7	34,40	145
4900220080	6KŞ ALLEN ANH KB 08	22,45	143	4910220008	TORX ALLEN ANH T8	34,40	145
4900220090	6KŞ ALLEN ANH KB 09	27,65	143	4910220009	TORX ALLEN ANH T9	34,60	145
4900220100	6KŞ ALLEN ANH KB 10	34,15	143	4910220010	TORX ALLEN ANH T10	34,60	145
4900220120	6KŞ ALLEN ANH KB 12	49,65	143	4910220015	TORX ALLEN ANH T15	35,65	145
4900220140	6KŞ ALLEN ANH KB 14	79,20	143	4910220020	TORX ALLEN ANH T20	37,30	145
4900220160	6KŞ ALLEN ANH KB 16	146,30	143	4910220025	TORX ALLEN ANH T25	37,30	145
4900220170	6KŞ ALLEN ANH KB 17	157,75	143	4910220027	TORX ALLEN ANH T27	37,30	145
4900220190	6KŞ ALLEN ANH KB 19	195,05	143	4910220030	TORX ALLEN ANH T30	39,95	145
4900220220	6KŞ ALLEN ANH KB 22	325,65	143	4910220040	TORX ALLEN ANH T40	42,55	145
4900220240	6KŞ ALLEN ANH KB 24	439,60	143	4910220045	TORX ALLEN ANH T45	52,15	145
4900003110	6KŞ ALLEN ANH KB TK10	153,55	143	4910220050	TORX ALLEN ANH T50	59,40	145
4900003112	6KŞ ALLEN ANH KB TK12	211,60	143	4910220055	TORX ALLEN ANH T55	82,45	145
4901221984	6KŞ ALLEN ANH 5/64 SAE	6,70	143	4910220060	TORX ALLEN ANH T60	113,60	145
4901222381	6KŞ ALLEN ANH 3/32 SAE	7,30	143	4910007108	TORX ALLEN ANH TK8	299,25	145
4901223125	6KŞ ALLEN ANH 1/8 SAE	8,80	143	4912003107	KST ALLEN ANH 2,5-10	303,35	146
4901223968	6KŞ ALLEN ANH 5/32 SAE	10,75	143	4912000007	KST ALLEN ANH 1,5-6	192,20	146
4901224762	6KŞ ALLEN ANH 3/16 SAE	11,05	143	4909220009	TTİP TORX ALLEN ANH T9	87,75	146
4901225556	6KŞ ALLEN ANH 7/32 SAE	14,80	143	4909220010	TTİP TORX ALLEN ANH T10	89,40	146
4901226350	6KŞ ALLEN ANH 1/4 SAE	18,05	143	4909220015	TTİP TORX ALLEN ANH T15	91,30	146
4901227937	6KŞ ALLEN ANH 5/16 SAE	22,45	143	4909220020	TTİP TORX ALLEN ANH T20	92,05	146
4901229825	6KŞ ALLEN ANH 3/8 SAE	30,95	143	4909220025	TTİP TORX ALLEN ANH T25	94,15	146
4901221111	6KŞ ALLEN ANH 7/16 SAE	41,65	143	4909220027	TTİP TORX ALLEN ANH T27	104,65	146
4901221270	6KŞ ALLEN ANH 1/2 SAE	52,55	143	4909220030	TTİP TORX ALLEN ANH T30	107,55	146
4901221428	6KŞ ALLEN ANH 9/16 SAE	76,60	143	4909220040	TTİP TORX ALLEN ANH T40	111,55	146

KOD	ÜRÜN	FİYAT	SAYFA	KOD	ÜRÜN	FİYAT	SAYFA
4909008108	TTİP TORX ALLEN ANH TK8	778,40	146	5550240009	DÜZ PİM ZMB 09	86,60	152
4920220025	TTİP 6KŞ ALLEN ANH 2,5	47,35	147	5550240010	DÜZ PİM ZMB 10	87,45	152
4920220030	TTİP 6KŞ ALLEN ANH 03	48,25	147	5550240105	DÜZ PİM ZMB KKPL 05	66,75	152
4920220040	TTİP 6KŞ ALLEN ANH 04	54,05	147	5550001006	DÜZ PİM ZMB TK6	468,55	153
4920220050	TTİP 6KŞ ALLEN ANH 05	57,75	147	5600006106	KSK&ZMB SET6	427,80	153
4920220060	TTİP 6KŞ ALLEN ANH 06	66,00	147	5700240003	KYŞ ZMB 03	44,75	153
4920220070	TTİP 6KŞ ALLEN ANH 07	69,30	147	5700240004	KYŞ ZMB 04	46,80	153
4920220080	TTİP 6KŞ ALLEN ANH 08	81,45	147	5700240005	KYŞ ZMB 05	50,85	153
4920220100	TTİP 6KŞ ALLEN ANH 10	123,30	147	5700240006	KYŞ ZMB 06	51,75	153
4920008108	TTİP 6KŞ ALLEN ANH TK8	547,45	147	5700240007	KYŞ ZMB 07	57,05	153
4921220025	TTİP 6KŞ YVRL BAŞL ALLEN ANH 2,5	61,45	147	5700240008	KYŞ ZMB 08	60,65	153
4921220030	TTİP 6KŞ YVRL BAŞL ALLEN ANH 03	62,25	147	5700240009	KYŞ ZMB 09	67,65	153
4921220040	TTİP 6KŞ YVRL BAŞL ALLEN ANH 04	69,90	147	5700240010	KYŞ ZMB 10	72,05	153
4921220050	TTİP 6KŞ YVRL BAŞL ALLEN ANH 05	75,00	147	5700240011	KYŞ ZMB 11	77,50	153
4921220060	TTİP 6KŞ YVRL BAŞL ALLEN ANH 06	85,70	147	5700240012	KYŞ ZMB 12	92,75	153
4921220070	TTİP 6KŞ YVRL BAŞL ALLEN ANH 07	89,85	147	5700240013	KYŞ ZMB 13	97,65	153
4921220080	TTİP 6KŞ YVRL BAŞL ALLEN ANH 08	96,55	147	5700240014	KYŞ ZMB 14	107,20	153
4921220100	TTİP 6KŞ YVRL BAŞL ALLEN ANH 10	160,20	147	5700240015	KYŞ ZMB 15	123,05	153
4921008108	TTİP 6KŞ YVRL BAŞL ALLEN ANH TK8	700,90	147	5700240016	KYŞ ZMB 16	134,65	153
5010230006	ISKPL DÜZ 06	87,45	151	5700240017	KYŞ ZMB 17	147,25	153
5010230008	ISKPL DÜZ 08	93,45	151	5700240018	KYŞ ZMB 18	160,65	153
5010230010	ISKPL DÜZ 10	98,75	151	5700240019	KYŞ ZMB 19	174,60	153
5010230012	ISKPL DÜZ 12	108,35	151	5700240020	KYŞ ZMB 20	185,95	153
5010230014	ISKPL DÜZ 14	112,05	151	5700002110	KYŞ ZMB TK10	621,80	153
5010230016	ISKPL DÜZ 16	119,85	151	5700002112	KYŞ ZMB TK12	826,65	153
5010230018	ISKPL DÜZ 18	129,90	151	5800250100	TSVY ÇKÇ 100GR	97,35	154
5010230020	ISKPL DÜZ 20	144,50	151	5800250200	TSVY ÇKÇ 200GR	106,00	154
5010230022	ISKPL DÜZ 22	156,60	151	5800250300	TSVY ÇKÇ 300GR	128,45	154
5010230024	ISKPL DÜZ 24	169,20	151	5800250500	TSVY ÇKÇ 500GR	148,70	154
5010230026	ISKPL DÜZ 26	175,30	151	5800251000	TSVY ÇKÇ 1000GR	207,65	154
5010230030	ISKPL DÜZ 30	187,20	151	5800251500	TSVY ÇKÇ 1500GR	282,25	154
5010008106	ISKPL TK6	713,40	151	5800252000	TSVY ÇKÇ 2000GR	347,10	154
5500230100	DÜZ KSK 100	52,40	151	5810251000	EMNY ÇKÇ 1000GR	280,35	154
5500230125	DÜZ KSK 125	62,95	151	5810251500	EMNY ÇKÇ 1500GR	387,85	154
5500230150	DÜZ KSK 150	80,95	151	5810252000	EMNY ÇKÇ 2000GR	479,05	154
5500230175	DÜZ KSK 175	91,40	151	5850250030	PLS ÇKÇ 30	136,30	154
5500230200	DÜZ KSK 200	127,10	151	5850250040	PLS ÇKÇ 40	165,85	154
5500230250	DÜZ KSK 250	156,40	151	5850250050	PLS ÇKÇ 50	207,35	154
5500230300	DÜZ KSK 300	250,60	151	5870250400	LSTK ÇKÇ 400GR	269,50	154
5500231250	DÜZ KSK KLN İZL 250	199,00	151	5865251000	MDRG 1000GR	256,85	155
5500231300	DÜZ KSK KLN İZL 300	290,10	151	5865251500	MDRG 1500GR	306,80	155
5510230125	TSVY DÜZ KSK 125	71,70	152	6410250800	NCK 800GR	512,85	155
5510230150	TSVY DÜZ KSK 150	89,65	152	6400250600	KSR 400GR	283,15	155
5520230125	TRN KSK 130	80,45	152	6401250600	USTA KSR 400GR	283,15	155
5520230150	TRN KSK 150	95,95	152	375050020	KBLO SYRC 8-28	194,65	159
5540244120	NKT ZMB 4X120	60,60	152	375250625	KBLO SYRC (T 6/300 - Ç 1,5/25)	177,10	159
5540245120	NKT ZMB 5X120	71,35	152	375150012	KOAK KBLO SYRC	252,65	159
5540245150	NKT ZMB 5X150	79,05	152	375350054	MKNK KBLO SYRC 0,5-4	333,00	159
5540240412	NKT ZMB KKPL 4X120	59,90	152	588150013	KROM ŞRT MT3	93,65	159
5545240002	KNK PİM ZMB 02	52,15	152	588150015	KROM ŞRT MT5	105,75	159
5545240003	KNK PİM ZMB 03	56,80	152	588150003	PLS ŞRT MT3	78,70	159
5545240004	KNK PİM ZMB 04	63,90	152	588150005	PLS ŞRT MT5	94,55	159
5545240005	KNK PİM ZMB 05	65,15	152	588650020	ARZTİP FİB ŞRT SAPLI MT20	189,85	160
5545240006	KNK PİM ZMB 06	96,05	152	588650030	ARZTİP FİB ŞRT SAPLI MT30	202,70	160
5545240007	KNK PİM ZMB 07	100,15	152	588650050	ARZTİP FİB ŞRT SAPLI MT50	325,60	160
5545240008	KNK PİM ZMB 08	103,95	152	588050040	SU TRZ 40CM	283,25	160
5545240009	KNK PİM ZMB 09	106,40	152	588050050	SU TRZ 50CM	307,20	160
5545240010	KNK PİM ZMB 10	108,55	152	588050060	SU TRZ 60CM	334,05	160
5545240012	KNK PİM ZMB 12	113,40	152	588050070	SU TRZ 70CM	358,65	160
5545240103	KNK PİM ZMB KKPL 03	59,35	152	588050080	SU TRZ 80CM	387,50	160
5550240002	DÜZ PİM ZMB 02	74,75	152	588050100	SU TRZ 100CM	441,10	160
5550240003	DÜZ PİM ZMB 03	74,75	152	588050120	SU TRZ 120CM	522,00	160
5550240004	DÜZ PİM ZMB 04	76,00	152	588050150	SU TRZ 150CM	601,45	160
5550240005	DÜZ PİM ZMB 05	76,00	152	588050200	SU TRZ 200CM	840,25	160
5550240006	DÜZ PİM ZMB 06	76,60	152	588750150	KMPS 150	683,85	160
5550240007	DÜZ PİM ZMB 07	79,75	152	589050830	TSTR KOL 30CM	296,25	160
5550240008	DÜZ PİM ZMB 08	85,45	152	6735270300	BDM TSTR 300	296,75	160

KOD	ÜRÜN	FİYAT	SAYFA	KOD	ÜRÜN	FİYAT	SAYFA
590150020	SENTİL 0,05-1	62,45	161	6211270275	KPRT MKS 275 SOL YAY	331,90	172
590250020	SENTİL 2-35/1000 SAE	97,65	161	6211270300	KPRT MKS 300 SOL YAY	378,45	172
6195260260	PRÇN TBNC	312,45	161	6820270200	TNK MKS 200	204,00	172
6220260500	SPRL MIKN 500GR	196,65	161	6820270250	TNK MKS 250	260,50	172
6220261000	SPRL MIKN 1000GR	208,25	161	6820270300	TNK MKS 300	283,95	172
6225260200	MDN YAĞ FLEX UÇ 200CC	104,30	161	6821270250	TNK MKS YAY 250	282,90	172
6225260300	MDN YAĞ FLEX UÇ 300CC	117,35	161	6821270300	TNK MKS YAY 300	309,50	172
6225260500	MDN YAĞ FLEX UÇ 500CC	128,80	161	6800270180	KYM MKS DÜZ 180	246,20	173
6230260300	GRES POMP KAVAL BORU 300CC	268,00	163	6801270180	KYM MKS EĞRİ 180	269,30	173
6230260500	GRES POMP KAVAL BORU 500CC	330,10	163	6815270200	TEL KSM MKS 200	124,50	173
6240260810	2A TAPA ANH 08X10	98,85	163	6740270140	KMB MKS 140	225,40	173
6350260300	LVY OLK 300	93,80	163	6740270190	KMB MKS 190	264,50	173
6350260400	LVY OLK 400	118,25	163	6710270230	BAĞ MKS LUX 230	217,50	174
6350260500	LVY OLK 500	164,50	163	6715270225	BAĞ MKS COMF 225	331,25	174
6350260600	LVY OLK 600	200,85	163	6720270220	BAĞ MKS HAF 220	384,15	174
6360260600	LVY OLK KVRK UÇ 600	221,90	163	6712270210	ELMA MKS 210	384,80	174
6370260100	YAĞ FLT SÖKM 100	146,60	163	676050042	PLS BORU KSM MKS 42	831,85	175
6375266512	2YÖN 3YAY YAĞ FLT SÖKM 65-120	512,85	164	676050063	PLS BORU KSM MKS 63	1.459,55	175
6380266016	2ZNCR YAĞ FLT SÖKM 60-16	1.388,90	164	6850280322	KÇK BORU KSC	179,25	175
637350140	KYŞ YAĞ FLT SÖKM 60-140	359,35	164	6855280330	STD BORU KSC	248,10	175
637450140	ZNCR YAĞ FLT SÖKM 60-140	309,65	164	6860280635	TLSK BORU KSC	527,65	175
637550100	AYR YAĞ FLT SÖKM 100	171,65	164	6865281050	PROF BORU KSC	1.331,85	175
639050125	SGM ÇMBR 125	306,45	165	7010290810	STD ÇEK 2KOL 8X10	610,80	179
639050175	SGM ÇMBR 175	584,65	165	7010291210	STD ÇEK 2KOL 12X10	653,15	179
741550003	3 SRL TEL FRÇ	22,60	165	7010291615	STD ÇEK 2KOL 16X15	1.113,45	179
741550004	4 SRL TEL FRÇ	23,90	165	7010292015	STD ÇEK 2KOL 20X15	1.218,00	179
741550005	5 SRL TEL FRÇ	26,70	165	7010292520	STD ÇEK 2KOL 25X20	2.103,65	179
741550006	6 SRL TEL FRÇ	28,55	165	7010293520	STD ÇEK 2KOL 35X20	2.554,90	179
741650001	KVRK UÇ FRÇ PLS SAP 270	35,35	165	7010295220	STD ÇEK 2KOL 52X20	3.755,75	179
741050010	MKR UZT KBLO MT10	708,85	165	7010006105	ÇEK&SHP SET6	5.926,10	179
741050025	MKR UZT KBLO MT25	1.252,70	165	7020293720	STD ÇEK 3KOL 37X20	4.714,75	179
741050050	MKR UZT KBLO MT50	2.501,40	165	7020295220	STD ÇEK 3KOL 52X20	6.499,55	179
7401300100	MNGN DNR TBL 100	473,30	167	7030290808	MSTR ÇEK 2KOL 8X8	245,95	180
7401300125	MNGN DNR TBL 125	625,45	167	7030291212	MSTR ÇEK 2KOL 12X12	507,25	180
7401300150	MNGN DNR TBL 150	759,20	167	7030291616	MSTR ÇEK 2KOL 16X16	763,35	180
7401300175	MNGN DNR TBL 175	858,35	167	7030292320	MSTR ÇEK 2KOL 23X20	1.037,85	180
7400000100	MNGN (DNR TBL DHL) 100	2.080,95	167	7040290808	MSTR ÇEK 3KOL 8X8	471,20	180
7400000125	MNGN (DNR TBL DHL) 125	2.838,80	167	7040291212	MSTR ÇEK 3KOL 12X12	689,65	180
7400000150	MNGN (DNR TBL DHL) 150	3.589,90	167	7040291616	MSTR ÇEK 3KOL 16X16	1.014,10	180
7400000175	MNGN (DNR TBL DHL) 175	4.341,10	167	7040292320	MSTR ÇEK 3KOL 23X20	1.365,55	180
7400300100	MNGN 100	1.607,65	167	7050290604	BTR ÇEK 2KOL 6X4	273,75	180
7400300125	MNGN 125	2.213,35	167	7050290606	BTR ÇEK 2KOL 6X6	282,25	180
7400300150	MNGN 150	2.830,70	167	7050290808	BTR ÇEK 2KOL 8X8	296,35	180
7400300175	MNGN 175	3.482,75	167	7060290604	BTR ÇEK 3KOL 6X4	355,30	180
7300303012	İŞKN 30X12	373,75	168	7060290606	BTR ÇEK 3KOL 6X6	448,05	180
7300304012	İŞKN 40X12	441,55	168	7060290808	BTR ÇEK 3KOL 8X8	519,70	180
7300305012	İŞKN 50X12	452,65	168	7070292013	STİP ÇEK 2KOL 20X13	674,05	181
7300306012	İŞKN 60X12	472,50	168	7080292013	STİP ÇEK 3KOL 20X13	869,35	181
7300308012	İŞKN 80X12	501,15	168	7090292222	ÜNV ÇEK 2KOL 22X22	749,05	181
7300301012	İŞKN 100X12	571,95	168	7100292222	ÜNV ÇEK 3KOL 22X22	981,90	181
7310301005	KÇK İŞKN 10X5	160,75	168	7120290507	İÇ RLM ÇEK PENS 5-7 MDL-A	561,55	182
7310301505	KÇK İŞKN 15X5	169,40	168	7120290709	İÇ RLM ÇEK PENS 7-9 MDL-A	561,55	182
7310302005	KÇK İŞKN 20X5	175,65	168	7120290912	İÇ RLM ÇEK PENS 9-12 MDL-A	520,45	182
7310302505	KÇK İŞKN 25X5	183,10	168	7120291013	İÇ RLM ÇEK PENS 10-13 MDL-A	520,45	182
7310303005	KÇK İŞKN 30X5	189,55	168	7120291317	İÇ RLM ÇEK PENS 13-17 MDL-A	520,45	182
2350270018	DMR KSM MKS 18"	610,60	171	7120291419	İÇ RLM ÇEK PENS 14-19 MDL-A	533,10	182
2350270024	DMR KSM MKS 24"	898,75	171	7120291621	İÇ RLM ÇEK PENS 16-21 MDL-A	533,10	182
2350270030	DMR KSM MKS 30"	1.406,95	171	7120291823	İÇ RLM ÇEK PENS 18-23 MDL-A	638,15	182
2350270036	DMR KSM MKS 36"	1.820,90	171	7120292025	İÇ RLM ÇEK PENS 20-25 MDL-A	673,75	182
2350006104	DMR KSM MKS&SHP SET5	5.818,30	171	7120292530	İÇ RLM ÇEK PENS 25-30 MDL-A	701,75	182
6205270240	AL&SAC KSM MKS 240 SAĞ	241,35	171	7120293037	İÇ RLM ÇEK PENS 30-37 MDL-A	813,05	182
6206270240	AL&SAC KSM MKS 240 SOL	241,35	171	7120293542	İÇ RLM ÇEK PENS 35-42 MDL-A	854,45	182
6207270240	AL&SAC KSM MKS 240 DÜZ	241,35	171	7120293845	İÇ RLM ÇEK PENS 38-45 MDL-A	900,80	182
6210270250	KPRT MKS 250 SAĞ YAY	303,45	172	7120294350	İÇ RLM ÇEK PENS 43-50 MDL-A	1.024,20	182
6210270275	KPRT MKS 275 SAĞ YAY	331,90	172	7120292540	İÇ RLM ÇEK PENS 25-40 MDL-B	1.137,35	182
6210270300	KPRT MKS 300 SAĞ YAY	378,45	172	7120293575	İÇ RLM ÇEK KOL 35-75	572,15	182
6211270250	KPRT MKS 250 SOL YAY	303,45	172	7120296013	İÇ RLM ÇEK KOL 60-130	1.159,30	182

KOD	ÜRÜN	FİYAT	SAYFA
7122290560	DIŞ RLM ÇEK ÇENE 5-60	868,45	183
7122291275	DIŞ RLM ÇEK ÇENE 12-75	1.087,95	183
7122292211	DIŞ RLM ÇEK ÇENE 22-115	1.698,95	183
7122292515	DIŞ RLM ÇEK ÇENE 25-155	2.659,45	183
7122293022	DIŞ RLM ÇEK ÇENE 30-220	7.268,05	183
7122294028	DIŞ RLM ÇEK ÇENE 40-280	16.233,30	183
7122294011	DIŞ RLM ÇEK KOL 40-115	1.618,60	183
7122295520	DIŞ RLM ÇEK KOL 55-205	2.562,20	183
7122299026	DIŞ RLM ÇEK KOL 90-260	3.627,50	183
7122291036	DIŞ RLM ÇEK KOL 100-360	7.465,35	183
7122291443	DIŞ RLM ÇEK KOL 140-435	14.591,25	183
7126290018	RTL ÇEK 18	486,95	183
7126290025	RTL ÇEK 25	667,55	183
7126290029	RTL ÇEK 29	887,95	183
7126290040	RTL ÇEK 40	1.253,65	183
7126290045	RTL ÇEK 45	1.582,75	183
150010607	2A ANH SB 0607 ELTA	18,85	186
150010809	2A ANH SB 0809 ELTA	19,15	186
150011011	2A ANH SB 1011 ELTA	20,75	186
150011213	2A ANH SB 1213 ELTA	23,00	186
150011415	2A ANH SB 1415 ELTA	26,65	186
150011617	2A ANH SB 1617 ELTA	30,85	186
150011819	2A ANH SB 1819 ELTA	33,10	186
150012022	2A ANH SB 2022 ELTA	37,60	186
150012123	2A ANH SB 2123 ELTA	41,00	186
150012426	2A ANH SB 2426 ELTA	47,05	186
150012528	2A ANH SB 2528 ELTA	56,45	186
150012732	2A ANH SB 2732 ELTA	67,40	186
150002108	2A ANH SB TK8 ELTA	209,95	186
150002112	2A ANH SB TK12 ELTA	421,85	186
350020006	KMB ANH SB 06 ELTA	24,60	187
350020007	KMB ANH SB 07 ELTA	26,15	187
350020008	KMB ANH SB 08 ELTA	28,25	187
350020009	KMB ANH SB 09 ELTA	29,25	187
350020010	KMB ANH SB 10 ELTA	32,90	187
350020011	KMB ANH SB 11 ELTA	33,95	187
350020012	KMB ANH SB 12 ELTA	36,20	187
350020013	KMB ANH SB 13 ELTA	36,75	187
350020014	KMB ANH SB 14 ELTA	39,65	187
350020015	KMB ANH SB 15 ELTA	42,50	187
350020016	KMB ANH SB 16 ELTA	45,60	187
350020017	KMB ANH SB 17 ELTA	48,85	187
350020018	KMB ANH SB 18 ELTA	54,15	187
350020019	KMB ANH SB 19 ELTA	57,10	187
350020020	KMB ANH SB 20 ELTA	58,15	187
350020021	KMB ANH SB 21 ELTA	67,60	187
350020022	KMB ANH SB 22 ELTA	77,25	187
350020024	KMB ANH SB 24 ELTA	94,30	187
350020027	KMB ANH SB 27 ELTA	111,15	187
350020030	KMB ANH SB 30 ELTA	127,55	187
350020032	KMB ANH SB 32 ELTA	133,70	187
350002108	KMB ANH SB TK8 ELTA	283,85	187
350002112	KMB ANH SB TK12 ELTA	508,25	187
350002117	KMB ANH SB TK17 ELTA	738,90	187
350002121	KMB ANH SB TK21 ELTA	1.205,60	187
450030607	2A YLD ANH SB 0607 ELTA	42,45	188
450030809	2A YLD ANH SB 0809 ELTA	42,95	188
450031011	2A YLD ANH SB 1011 ELTA	47,70	188
450031213	2A YLD ANH SB 1213 ELTA	53,90	188
450031415	2A YLD ANH SB 1415 ELTA	56,60	188
450031617	2A YLD ANH SB 1617 ELTA	64,00	188
450031819	2A YLD ANH SB 1819 ELTA	76,50	188
450032022	2A YLD ANH SB 2022 ELTA	83,75	188
450032123	2A YLD ANH SB 2123 ELTA	96,00	188
450032426	2A YLD ANH SB 2426 ELTA	111,75	188
450032528	2A YLD ANH SB 2528 ELTA	122,50	188
450032732	2A YLD ANH SB 2732 ELTA	134,85	188

KOD	ÜRÜN	FİYAT	SAYFA
450002108	2A YLD ANH SB TK8 ELTA	467,85	188
450002112	2A YLD ANH SB TK12 ELTA	932,95	188
601010008	KURB ANH 8" ELTA	146,50	188
601010010	KURB ANH 10" ELTA	220,55	188
601010012	KURB ANH 12" ELTA	291,45	188
1115060010	1/2" GKŞ LKM ANH 10 ELTA	31,25	189
1115060011	1/2" GKŞ LKM ANH 11 ELTA	31,25	189
1115060012	1/2" GKŞ LKM ANH 12 ELTA	31,25	189
1115060013	1/2" GKŞ LKM ANH 13 ELTA	32,35	189
1115060014	1/2" GKŞ LKM ANH 14 ELTA	32,35	189
1115060015	1/2" GKŞ LKM ANH 15 ELTA	32,35	189
1115060016	1/2" GKŞ LKM ANH 16 ELTA	33,75	189
1115060017	1/2" GKŞ LKM ANH 17 ELTA	33,75	189
1115060018	1/2" GKŞ LKM ANH 18 ELTA	33,75	189
1115060019	1/2" GKŞ LKM ANH 19 ELTA	36,25	189
1115060020	1/2" GKŞ LKM ANH 20 ELTA	36,25	189
1115060021	1/2" GKŞ LKM ANH 21 ELTA	36,25	189
1115060022	1/2" GKŞ LKM ANH 22 ELTA	36,25	189
1115060023	1/2" GKŞ LKM ANH 23 ELTA	39,40	189
1115060024	1/2" GKŞ LKM ANH 24 ELTA	39,40	189
1115060026	1/2" GKŞ LKM ANH 26 ELTA	44,25	189
1115060027	1/2" GKŞ LKM ANH 27 ELTA	50,35	189
1115060028	1/2" GKŞ LKM ANH 28 ELTA	53,00	189
1115060030	1/2" GKŞ LKM ANH 30 ELTA	53,00	189
1115060032	1/2" GKŞ LKM ANH 32 ELTA	56,65	189
1514064025	1/2" T KOL 250 ELTA	117,30	189
1514066250	1/2" T KOL LKM ADP ELTA	67,15	189
1514064125	1/2" ARA KOL 125 ELTA	61,45	189
1514064250	1/2" ARA KOL 250 ELTA	106,60	189
1514064065	1/2" MFSL 65 ELTA	81,65	189
1514065250	1/2" CRC KOL 250 ELTA	249,85	190
1115002017	1/2" GKŞ LKM ANH SET17 ELTA	1.001,70	190
1115002024	1/2" GKŞ LKM ANH SET24 ELTA	1.303,55	190
2203100010	1" MŞL BORU ANH 85 ELTA	246,15	191
2203100015	1-1/2" MŞL BORU ANH 85 ELTA	378,30	191
2203100020	2" MŞL BORU ANH 85 ELTA	564,10	191
2203100030	3" MŞL BORU ANH 85 ELTA	851,20	191
2401110240	FORT PNS 240 ELTA	232,40	191
2509110225	AYR PNS 225 ELTA	224,05	191
3021121160	OPAK KMB PNS 160 ELTA	120,10	192
3021121180	OPAK KMB PNS 180 ELTA	146,95	192
3021121200	OPAK KMB PNS 200 ELTA	179,15	192
3221131160	OPAK DÜZ UÇ KRGB 160 ELTA	130,35	192
3221131200	OPAK DÜZ UÇ KRGB 200 ELTA	149,20	192
3701161140	OPAK YNKSK 140 ELTA	114,05	192
3701161160	OPAK YNKSK 160 ELTA	134,00	192
3801150160	KRPTN 160 ELTA	130,60	192
3801150180	KRPTN 180 ELTA	141,05	192
3801150200	KRPTN 200 ELTA	176,35	192
3832150225	BTN KRPTN 225 ELTA	168,00	192
3832150250	BTN KRPTN 250 ELTA	191,45	192
3832150280	BTN KRPTN 280 ELTA	229,60	192
4170170680	DĞŞK UÇ TRNV 6X80 ELTA	48,85	192
4150170380	OPAK DÜZ UÇ TRNV 3X80 ELTA	21,20	193
4150170480	OPAK DÜZ UÇ TRNV 4X80 ELTA	24,45	193
4150174100	OPAK DÜZ UÇ TRNV 4X100 ELTA	26,10	193
4150175100	OPAK DÜZ UÇ TRNV 5X100 ELTA	31,45	193
4150175125	OPAK DÜZ UÇ TRNV 5X125 ELTA	36,25	193
4150176100	OPAK DÜZ UÇ TRNV 6X100 ELTA	32,70	193
4150176125	OPAK DÜZ UÇ TRNV 6X125 ELTA	37,15	193
4150176150	OPAK DÜZ UÇ TRNV 6X150 ELTA	41,00	193
4150177150	OPAK DÜZ UÇ TRNV 7X150 ELTA	48,00	193
4150178150	OPAK DÜZ UÇ TRNV 8X150 ELTA	51,95	193
4150178175	OPAK DÜZ UÇ TRNV 8X175 ELTA	58,25	193
4170180360	OPAK YLD UÇ TRNV 3X60 ELTA	23,95	193
4170184580	OPAK YLD UÇ TRNV 4,5X80 ELTA	32,35	193
4170186100	OPAK YLD UÇ TRNV 6X100 ELTA	38,95	193

KOD	ÜRÜN	FİYAT	SAYFA
4170188150	OPAK YLD UÇ TRNV 8X150 ELTA	73,60	193
4150008106	OPAK DÜZ&YLD UÇ TRNV SET6 ELTA	212,35	193
4150008107	OPAK DÜZ&YLD UÇ TRNV SET7 ELTA	254,10	193
4908220015	6KŞ ALLEN ANH 1,5 ELTA	2,85	194
4908220020	6KŞ ALLEN ANH 02 ELTA	3,60	194
4908220025	6KŞ ALLEN ANH 2,5 ELTA	4,30	194
4908220030	6KŞ ALLEN ANH 03 ELTA	4,95	194
4908220035	6KŞ ALLEN ANH 3,5 ELTA	5,70	194
4908220040	6KŞ ALLEN ANH 04 ELTA	6,60	194
4908220050	6KŞ ALLEN ANH 05 ELTA	6,90	194
4908220060	6KŞ ALLEN ANH 06 ELTA	9,55	194
4908220070	6KŞ ALLEN ANH 07 ELTA	13,50	194
4908220080	6KŞ ALLEN ANH 08 ELTA	15,65	194
4908220090	6KŞ ALLEN ANH 09 ELTA	22,15	194
4908220100	6KŞ ALLEN ANH 10 ELTA	23,80	194
4908220120	6KŞ ALLEN ANH 12 ELTA	34,80	194
4908003107	6KŞ ALLEN ANH TK7 ELTA	38,75	194
4908003109	6KŞ ALLEN ANH TK9 ELTA	78,20	194
4908003110	6KŞ ALLEN ANH TK10 ELTA	113,00	194
4922220025	TTİP ALLEN ANH 2,5 ELTA	39,15	194
4922220030	TTİP ALLEN ANH 03 ELTA	39,30	194
4922220040	TTİP ALLEN ANH 04 ELTA	39,70	194
4922220050	TTİP ALLEN ANH 05 ELTA	45,05	194
4922220060	TTİP ALLEN ANH 06 ELTA	49,45	194
4922220070	TTİP ALLEN ANH 07 ELTA	51,15	194
4922220080	TTİP ALLEN ANH 08 ELTA	61,65	194
4922220100	TTİP ALLEN ANH 10 ELTA	107,65	194
4922008108	TTİP ALLEN ANH TK8 ELTA	433,10	194
4915006106	KST ALLEN ANH 2,5-8 ELTA	192,20	195
5011230006	ISKPL DÜZ 06 ELTA	72,50	195
5011230008	ISKPL DÜZ 08 ELTA	76,75	195
5011230010	ISKPL DÜZ 10 ELTA	81,20	195
5011230012	ISKPL DÜZ 12 ELTA	89,05	195
5011230014	ISKPL DÜZ 14 ELTA	92,15	195
5011230016	ISKPL DÜZ 16 ELTA	98,45	195
5011230018	ISKPL DÜZ 18 ELTA	106,90	195
5011230020	ISKPL DÜZ 20 ELTA	118,60	195
5011230022	ISKPL DÜZ 22 ELTA	128,85	195
5011230024	ISKPL DÜZ 24 ELTA	138,90	195
5011230026	ISKPL DÜZ 26 ELTA	144,15	195
5011230030	ISKPL DÜZ 30 ELTA	153,70	195
5884260003	PLS ŞRT MT3 ELTA	32,85	195
5884260005	PLS ŞRT MT5 ELTA	47,35	195
5891260830	TSTR KOL 300 ELTA	117,35	195
6351260400	LVEY OLK 400 ELTA	90,45	195
6351260500	LVEY OLK 500 ELTA	132,55	195
6351260600	LVEY OLK 600 ELTA	172,75	195
6730270550	ÇİM KSM MKS DÜZ AĞZ 550 ELTA	204,95	196
6731270650	ÇİM KSM MKS EĞRİ AĞZ 650 ELTA	366,30	196
6721270205	BAĞ MKS 205 ELTA	155,15	196
6722270220	BAĞ MKS HAF 220 ELTA	223,90	196









İZELTAŞ EL ALETLERİ SANAYİ VE TİCARET A.Ş

Kemalpaşa Cad. No: 303
Işıkent / İzmir / TÜRKİYE

Sipariş Telefon
Phone for orders

DT: +90 232 472 13 92
T: +90 232 472 13 75
F: +90 232 472 13 78

Adana Bölge Müdürlüğü
Adana Office

+90 533 495 53 09

Ankara Bölge Müdürlüğü
Ankara Office

+90 533 603 47 29

İstanbul Bölge Müdürlüğü
İstanbul Office

+90 533 603 41 81
+90 535 461 54 87

www.izeltas.com.tr

DİJİTAL DÜNYA'DA BİZİ TAKİP EDİN

Instagram: [izeltas_](https://www.instagram.com/izeltas_)
Facebook: [/izeltaselaetleri](https://www.facebook.com/izeltaselaetleri)
YouTube: [İZELTAŞ](https://www.youtube.com/IZELTAS)
LinkedIn: [izeltas A.S.](https://www.linkedin.com/company/izeltas-a.s.)